



# **Maine Volunteer River Monitoring Program**

## **Appendix 2**

### **Standard Operating Procedures Catalog ("SOP Cookbook")**



## List of Standard Operating Procedures (SOPs)

SOP-01. METHODS FOR COLLECTING WATER GRAB SAMPLES.....	PDF PAGE 3
SOP-02. METHODS FOR SELECTING AND DOCUMENTING SITE LOCATIONS.....	PDF PAGE 17
SOP-03. METHODS FOR USING HACH HQ30D METER (DO AND TEMP).....	PDF PAGE 21
SOP-04. METHODS FOR USING YSI 550A METER (DO AND TEMP).....	PDF PAGE 161
SOP-05. METHODS FOR USING YSI DO200 METER (DO AND TEMP).....	PDF PAGE 186
SOP-06. METHODS FOR USING LAMOTTE 7414 & 5860 KITS (DO AND TEMP).....	PDF PAGE 233
SOP-07. METHODS FOR USING LAMOTTE 5856 KIT (DO AND TEMP).....	PDF PAGE 261
SOP-08. METHODS FOR USING YSI 85 METER (DO, TEMP AND COND).....	PDF PAGE 273
SOP-09. METHODS FOR USING OAKTON ECTESTR 11 (TEMP AND COND).....	PDF PAGE 341
SOP-10. METHODS FOR USING HACH 2100P TURBIDIMETER (TURB).....	PDF PAGE 351
SOP-11. METHODS FOR USING LAMOTTE 2020E TURBIDIMETER (TURB).....	PDF PAGE 435
SOP-12. METHODS FOR USING IDEXX COLILERT (BACTERIA).....	PDF PAGE 485
SOP-13. METHODS FOR USING YSI PRO PLUS METER (DO, TEMP AND COND).....	PDF PAGE 528
SOP-14. METHODS FOR USING YSI PRO ODO METER (DO AND TEMP).....	PDF PAGE 610
SOP-15. METHODS FOR USING YSI PRO 2030 METER (DO, TEMP AND COND).....	PDF PAGE 646
SOP-16. METHODS FOR USING EXTECH REFRACTOMETER (SALINITY).....	PDF PAGE 681
SOP-17. METHODS FOR USING YSI EC300A METER (COND AND TEMP).....	PDF PAGE 687
SOP-18. METHODS FOR USING YSI 55 METER (DO AND TEMP).....	PDF PAGE 704
SOP-19. METHODS FOR USING YSI PRO 20 (DO AND TEMP).....	PDF PAGE 737
SOP-20. METHODS FOR USING YSI PRO SOLO (DO, TEMP AND COND).....	PDF PAGE 787



STANDARD OPERATING PROCEDURE  
MAINE VOLUNTEER RIVER MONITORING PROGRAM (VRMP)  
METHODS FOR COLLECTING  
WATER GRAB SAMPLES IN RIVERS AND STREAMS



Note: The mention of brand names does not constitute recommendation of a specific company.



## Volunteer River Monitoring Program (VRMP)

### Standard Operating Procedure Methods for Collecting Water Grab Samples

- 1. Applicability.** This standard operating procedure (SOP) is used by the Volunteer River Monitoring Program (VRMP) of the Maine Department of Environmental Protection's (DEP's) Bureau of Water Quality, Division of Environmental Assessment, Watershed Management Unit. It applies to the collection of water grab samples for water chemistry analysis [generally for nutrients, suspended sediments/solids, biochemical oxygen demand; see section 5-C-(1), below] that are collected by volunteers from rivers and streams in Maine.
- 2. Purpose.** The purpose of this SOP is to provide standardized methods for collecting water grab samples from rivers and streams in Maine.
- 3. Definition.** A water grab sample is a sample of river and stream water collected for the purpose of analyzing its constituent water chemistry.
- 4. Responsibilities**

#### *A. Volunteer Monitors & Volunteer Groups*

- **Certification.** It is the responsibility of the individual obtaining these water grab samples to maintain a current certification for the parameter(s) they collect if they wish their data to be entered into the VRMP database. Training for water sampling/testing will be provided to volunteers on an annual basis by VRMP/DEP staff, and certification will last for one year from the date of training.
- **Water Sample Collection.** It is the responsibility of the volunteer to collect water samples as specified in their (VRMP) volunteer group's Sampling and Analysis Plan (SAP).
- **Data Recording.** It is the responsibility of the individual obtaining this data to record the results and additional qualifying information on current VRMP field data sheets (see Appendix 5 of the VRMP's Quality Assurance Program Plan or QAPP) obtained from their affiliated watershed association or through the VRMP program of the DEP.
- **Submitting Samples to VRMP-Approved Laboratories.** Volunteers and/or volunteer groups will submit water grab samples to a VRMP-approved laboratory for analyses following protocols outlined in their approved SAP. See QAPP Appendix 11 information on approved laboratories. This includes the completion of laboratory chain of custody forms.



- **Data Quality Checks and Data Submission.** The data manager for the volunteer group will collect and enter volunteer field sheet data onto the appropriate computer file, perform quality assurance checks (Refer to Section 5.10 of the QAPP), and submit data to the VRMP – all following protocols outlined in the volunteer group’s latest SAP that has been approved by the VRMP.

**B. *VRMP-Approved Laboratories Used by the Volunteer Groups***

- **Sample Processing.** Laboratories will accept water quality samples and chain of custody forms from volunteer groups and then process/analyze the samples.
- **Sending Data and Quality Assurance Results.** Laboratories will send water quality data and quality assurance results to both the volunteer group’s data manager and the VRMP, simultaneously, using an electronic “EDD” (electronic data deliverable) format.

**C. *Volunteer River Monitoring Program (VRMP) Staff***

- **Oversight of Volunteer Groups and Volunteers.** VRMP staff will oversee volunteer groups and volunteers through a variety of ways including maintaining an up-to-date VRMP QAPP; reviewing SAPs of the volunteer groups; providing annual training/(re-) certification sessions for volunteers; conducting quality assurance checks on data submitted by volunteer groups and laboratories; and uploading data into the DEP’s EGAD (Environmental and Geographic Analysis Database) database. These tasks are described in greater detail in the VRMP’s latest QAPP.

**5. Guidelines and Procedures**

**A. Sampling period and location.** Sampling period and site location information will be documented in SAPs (which require approval by the VRMP) that are submitted by the volunteer groups prior to the beginning of a sampling season. Detailed information regarding how volunteer groups are to obtain and document site location information can be found in the VRMP’s Appendix 2 (SOP-02 - Methods for Selecting and Documenting Site Location) and Appendix 6 (Sampling Site Location Form).



## B. Supplies

- (1) For water samples:
  - (a) Water quality kits from a VRMP-approved laboratory, which include containers specific to parameter(s) measured [see section C (1) below] and preservatives, as required
  - (b) Waterproof labels (BE SURE TO STICK ON CONTAINER PRIOR TO SAMPLING)
  - (c) VRMP-approved water sampling device, if using OPTION 3 [i.e., sampling from bridges or boats; see section C below]
  - (d) VRMP approved laboratory-chain of custody sheets
  - (e) Permanent marker
  - (f) Pencil
- (2) Miscellaneous supplies (as needed [refer to Tables 3a {QA criteria} and 3c {sample preservation} in the latest VRMP QAPP])
  - (a) Cooler with ice
  - (b) Waders
  - (c) Gloves
    - Currently, gloves are considered OPTIONAL.
    - In the future, if groups begin to monitor phosphorus or metals, this issue may be revisited.
    - If wearing gloves, the VRMP recommends non-latex glove materials (e.g., nitrile) to help avoid possible allergic reactions.
  - (d) Personal floatation device (PFD)
  - (e) Anchor, if sampling from a boat (e.g., OPTIONS 2 or 3)

## C. Collecting Water Grab Samples in Field

- (1) Water samples for the VRMP are collected for all or a subset of the following parameters: bacteria (*E. coli*, fecal coliform, or *Enterococcus*); turbidity; suspended sediment concentration (SSC); hardness; alkalinity; total phosphorus (TP); ortho-phosphorus; total Kjeldahl-nitrogen; nitrate/nitrite-nitrogen; total suspended solids; total dissolved solids; chloride; pH; and specific conductance. (Other parameters, such as metals, are not currently part of the VRMP program, but may be in the future.) Parameters such as dissolved oxygen (DO), temperature, specific conductance, and turbidity will usually be analyzed by volunteer groups using a water quality meter or test kit. Separate VRMP SOPs exist for those parameters.
- (2) Record the sample kit number (pre-assigned by the laboratory) on the VRMP Data Sheet.



- (3) Collect water samples using appropriate sample container before stirring up sediments from the river or stream bottom, or, alternatively, collect samples upstream of any agitated (stirred-up) water where you have walked. Collect samples choosing one of the following OPTIONS:
- 1 - wading,
  - 2 - collecting from edge of river/stream or boat by reaching one's arm or by using an extension pole, or
  - 3 - VRMP-approved water sampling device, from either a bridge or boat, as appropriate.
- Be sure to avoid eddies, pools, and deadwater. See Appendix B of this document for more information on acceptable location of sample collection.
- (4) Avoid touching the inside or lip of the sample containers (e.g., bottles, cubitainers, Whirl-Pak® bags) or caps.
- (5) **OPTION 1** (“wading method”, collecting from within a stream/river)
- (a) Caution should be used in all cases, but especially when wading in rivers and streams deeper than two feet. If sampling within a stream or river, wearing waders and a U.S. Coast Guard approved Type-III floatation vest (PFD) are recommended. Additional caution should be used when the streambed or streambanks are composed of loose or slippery material such as rocks, bedrock, clay, or mud. Algae can make these materials even more slippery. *Do not wade into streams/ivers that are deeper than your thighs!!*
  - (b) Be sure waterproof label is on container and is properly labeled.
  - (c) Approach the stream from a downstream location, walking upstream to the sampling site. (This prevents the disturbance of bottom sediments that could contaminate the water quality sample.)
  - (d) Rinse sample containers in stream water three times (only for certain parameters, as specified in Appendix A of this document).  
*If using a Whirl-Pak ® for bacteria sampling (avoid collecting surface film):*
  - (e) The Whirl-Pak ® should be submerged before opening it to collect the water sample. Submerge it under water, open the bag and remove once it is approximately half-full. Roll up (whirl) the bag to close it and seal it by tying the two yellow tabs together. Using clean tongs with alligator clips that attach to the Whirl-Pak ® bag by its two yellow tabs is acceptable for holding the bag.  
*For all other containers (in both options, avoid collecting surface film):*
  - (f) (Alternative 1-a; submersing bottle before cap is unscrewed)  
With cap still screwed on, submerge bottle underwater. (It is okay to loosen cap before submersion.) Tip container upright, remove cap (keeping hand downstream of bottle), and allow water to fill container. Once container is full, place cap on while the container is still submersed. Remove container from water.
  - (g) (Alternative 1-b; unscrewing cap first and then submersing bottle)  
Remove cap from bottle. With bottle pointed upside-down, quickly submerge



the bottle under water, turn it upright, and allow it to fill with water. Once container is full, quickly remove it from water and cap.

(6) **OPTION 2** (Collecting from edge of river/stream or boat by reaching one's arm or by using an extension pole.)

- Edge of River or Stream: Reaching to collect a sample from edge of river/stream is acceptable if a well-mixed sample may be obtained. Use an extension pole to collect sample if well-mixed sample cannot be obtained by reaching.
- Boat Situations: For boat situations, refer to Appendix B to determine whether samples can be collected by reaching or whether a VRMP-approved sampling device (OPTION 3) is required.

**Reaching Method**

- (a) Caution should be used in all cases. If in a boat, wear a US Coast Guard-approved Type-III flotation vest (PFD) at all times for safety. Anchor the boat when in the correct position to sample. When sampling from a boat, sample from the upstream side of the boat.
- (b) Be sure waterproof label is on sampling container and is properly labeled.
- (c) Be careful not to contaminate the cap, neck, or inside the container with your fingers or other foreign objects.
- (d) Rinse sample containers in stream water three times (only for certain parameters, as specified in Appendix A of this document).
- (e) If using a Whirl-Pak ® for bacteria sampling (avoid collecting surface film):
  - (d) The Whirl-Pak ® should be submerged before opening it to collect the water sample. Submerge it under water, open the bag and remove once it is approximately half-full. Roll up (whirl) the bag to close it and seal it by tying the two yellow tabs together. Using clean tongs with alligator clips that attach to the Whirl-Pak ® bag by its two yellow tabs is acceptable for holding the bag.

*For all other containers (in both options, avoid collecting surface film):*
  - (e) (Alternative 1-a; submersing bottle before cap is unscrewed)  
With cap still screwed on, submerge bottle underwater. (It is okay to loosen cap before submersion.) Tip container upright, remove cap (keeping hand downstream of bottle), and allow water to fill container. Once container is full, place cap on while the container is still submersed. Remove container from water.
  - (f) (Alternative 1-b; unscrewing cap first and then submersing bottle)  
Remove cap from bottle. With bottle pointed upside-down, quickly submerge the bottle under water, turn it upright, and allow it to fill with water. Once container is full, quickly remove it from water and cap.

**Extension Pole Method** (not recommended for sampling by boat)

- (a) Be sure waterproof label is on container and is properly labeled.





- (b) Rinse the clamp end of the extension pole in the stream/river prior to sampling.
  - (c) Remove lid or stopper from sample container prior to sampling. Be careful not to contaminate the cap, neck, or inside the container with your fingers or other foreign objects.
  - (d) Securely attach the sample container to the extension pole using the clamps.
  - (e) Extend the pole to desired length. Ensure that a well-mixed sample will be collected. (Do not, however, extend the pole too far when sampling in high velocity streams to avoid damage to the pole.)
  - (f) Rinse sample container in stream water three times (only for certain parameters as specified in Appendix A of this document).
  - (g) Prepare to collect water sample by first rotating the extension pole until the sample container is oriented upside down.
  - (h) Immerse the sample container to desired depth and then rotate the rod underwater to fill the container. (Avoid collecting surface film.)
  - (i) Once the sample container is full, remove it from the water, cap it and remove it from the clamp.
- (7) **OPTION 3** (“VRMP-approved water sampling device” method; if collecting from a bridge or from a boat;)  
(See VRMP SOP-01b for a list and description of approved sampling devices. See Appendix B of this document for information on acceptable location of sample collection.)
- (a) Caution should be used in all cases. If sampling from a bridge, wear an orange vest for safety. If collecting samples from a boat, wear a US Coast Guard -approved Type-III flotation vest (PFD) at all times for safety.
  - (b) If on a boat, anchor it when in the correct position to sample.
  - (c) Be sure waterproof label is on appropriate containers and that they are properly labeled.
  - (d) Make sure the VRMP-approved water sampling device has been cleaned ahead of time according to directions in Appendix C of this document.
  - (e) Rinse the sampling device and any associated sample containers in stream water three times (only for certain parameters as specified in Appendix A of this document). (Make sure this is done from a safe location!) When on a bridge, dump the rinse water at least 20 feet away from where you plan to take the water sample. When on a boat, dump the rinse water on the downstream side of the boat.
  - (f) Lower the sampling device from the upstream side of the bridge or boat (whenever possible) into the river to the appropriate depth. Completely fill the sampling device with water. (See Appendix B for information on appropriate depth for sampling.)
  - (g) Pull the filled sampling device up and carry to a safe location. (Be sure to watch out for traffic.) Avoid bumping the sampling device against the bridge as you raise it to avoid any potential sample contamination.



- (h) Prepare to analyze your water sample. Place the sample container on a clean, stable surface such as the bottom of an upside-down 5-gallon bucket. Carefully open the sample device in order to access the water inside.
  - (i) *Dissolved oxygen and temperature:* In many cases volunteers will be monitoring dissolved oxygen (DO) and temperature directly off of bridges using meters and probes with long cords that follow other standard operating procedures (SOPs). If, instead, you are analyzing DO and temperature from the water within your sampling device, analyze the sample for DO and temperature first, following the appropriate equipment SOPs, before analyzing other parameters. Do not agitate the water before DO and temperature have been measured.
  - (j) *Other water quality parameters:* After DO and temperature have been measured, swirl and mix the water sample. Measure other parameters using the appropriate meters/probes (following their specific SOPs) or pour off water samples into their appropriate sample containers.
  - (k) Follow Appendix C for directions on how to clean and store the water sampling device.
- (9) Store and transport samples in cooler with ice, as appropriate (refer to Table 3c of the VRMP QAPP for more information).
- (10) Complete VRMP field data sheet (QAPP Appendix 5) and VRMP-approved laboratory chain of custody sheet.
- (11) Drop off samples at VRMP-approved laboratory within the holding time frame (see Table 3c of the VRMP QAPP for more details). Include a completed chain of custody sheet specific to your VRMP-approved laboratory.

#### **D. Quality Control**

- (1) At the beginning of each field season, all VRMP staff and VRMP volunteers who will collect water grab samples will have a training/(re-)certification session to (re)familiarize themselves with the contents of this SOP.
- (2) For every volunteer, a field duplicate will be collected for 10% (i.e., 1 for every 10 water grab samples) collected for laboratory analysis. However, if, for example, only 5 samples were collected for a given parameter in a given year by a volunteer, 1 field duplicate must still be collected for that parameter. The field duplicate must be processed by the same laboratory.
- (3) Laboratory: quality control samples analyzed in the laboratory are specified in their respective SOPs and generally include duplicate, spiked, and blank samples.
- (4) Refer to the VRMP QAPP for more QA/QC details.



## 6. References.

Maine Department of Environmental Protection (DEP). 2014. Protocols for Collecting Water Grab Samples in Rivers, Streams, and Freshwater Wetlands. Prepared by Tom Danielson, DEP, Augusta, Maine. Document ID: DEPLW0637.

Maine DEP. 2019. Maine Volunteer River Monitoring Program QAPP.



**Appendix A.** List of Water Quality Parameter Containers that Require or do not Require Rinsing with Stream Water (3 times) Prior to Actual Sampling. Containers for certain parameters should not be rinsed prior to sampling because they are a) easily contaminated, b) already washed/rinsed by the laboratory using a special protocol, or c) already contain a pre-measured preservative in them, which would be washed out if the container were to be rinsed.

<b>Water Quality Parameter Containers REQUIRING Rinsing Prior to Sampling</b>	
Maine State Health and Environmental Testing Laboratory (HETL)	<ul style="list-style-type: none"> <li>• pH</li> <li>• total dissolved solids</li> <li>• chloride</li> <li>• turbidity</li> <li>• solids/sediments (i.e., total suspended solids; suspended sediment concentration)</li> <li>• ortho-phosphorus (soluble reactive phosphorus)</li> <li>• nitrogen (NO<sub>2</sub>, NO<sub>3</sub>, TKN)</li> <li>• alkalinity <i>or</i> hardness</li> <li>• biochemical oxygen demand (BOD)</li> </ul>
<i>Add to this list as more labs get added to the VRMP list of approved labs.</i>	
<b>Water Quality Parameter Containers Which SHOULD NOT or DO NOT NEED TO BE RINSED Prior to Sampling</b>	
Maine State Health and Environmental Testing Laboratory (HETL)	<ul style="list-style-type: none"> <li>• total phosphorus</li> <li>• bacteria (i.e., <i>E. coli</i>, fecal coliform, or <i>Enterococcus</i>)</li> </ul>
<i>Add to this list as more labs get added to the VRMP list of approved labs.</i>	

**Appendix B. Required river/stream monitoring locations for inclusion in the VRMP.**

**Lateral Position Across a River/Stream**

→ Sampling needs to occur so that a flowing, well-mixed, representative sample is collected. If possible, volunteers should try to sample in the “center half of flow”. The center half of flow is usually close to the middle of the channel, though it sometimes can move away from the middle of the channel, following the thalweg (Figure 2), towards the outside of a river-bend.

→ Samplers need to avoid shore-related features such as:

- eddies
- deadwaters
- shallows
- jetties
- pools (even though parts of the thalweg may pass through them)
- docks (unless they within the center half of flow).

→ To obtain a well-mixed representative sample, volunteers can use a variety of techniques including:

- wading out by foot
- reaching out
- using an extension pole
- using a boat
- sampling from a bridge/culvert using a VRMP-approved water sampling device<sup>1</sup>

**Vertical Position in a River/Stream**

(In all cases, avoid allowing water surface films or “stirred-up bottom sediments” into the sample.  
Always face upstream when sampling.)

*(For Dissolved Oxygen & Temperature as well as any Other Water Quality Parameters)*

→ For rivers/streams that are non-wadeable, sample at mid-depth (if depth is known) or 1 meter below the surface.

→ For rivers/streams that are wadeable, sample at mid-depth or 1 ½ feet below the surface.

(Volunteers will specify which depth on their data sheet.)

*(For Dissolved Oxygen & Temperature Profiles)*

→ Sample at 1-m increments to obtain a vertical profile

**Longitudinal Position in River/Stream**

(when near crossing such as a bridge or culvert)

→ To avoid the possible effects of roads, bridges, or scour pools on water quality, the preferred location to sample is at the upstream end of a bridge or culvert crossing (as opposed to the downstream end) *unless*:

- (1) it is safer to sample at the downstream end;
- (2) the purpose of sampling at the downstream end of the crossing is to include any effects of the crossing on water quality.

→ Be sure to document where the sampling takes place with respect to a crossing, especially on the Site Location Description Form (Appendix 6).

**Impoundments**

→ Sample as close as possible\* to the deepest “hole” (depth) of the impoundment – generally in the vicinity of the upstream side of the dam. Bathymetry maps or sonar equipment can be used to determine river depths. \*(Do not risk your safety! Do not get too close to the dam! Do not go into “roped-off” sections of the impoundment.)

<sup>1</sup> See VRMP’s QAPP’s section 5.2 and also Appendix 2 SOP Cookbook (specifically, “Standard Operating Procedure - Methods for Collecting Water Grab Samples”; SOP-01, Appendix D) for details regarding VRMP-approved water sampling devices.



## **Appendix C. Cleaning and storage methods for VRMP-approved water sampling devices.**

### **A. Cleaning of sample devices before and after sampling events.**

1. Rinse devices thoroughly with distilled water.
2. Store upside down or covered between site visits.
3. Rinse devices with stream water three times prior to each sampling site (only for certain parameters, as specified in Appendix A of this document) and also after the last sampling site.

### **B. Storage of sample devices between sampling events.**

1. Empty out any water from with the device.
2. Prop open the sampling device a little so it can air dry. A clean plastic spoon or small, clean stick may do the trick.
3. Store the device in a clean area.

### **C. End of season storage.**

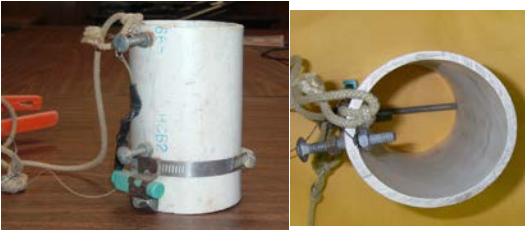


1. VRMP staff will collect all loaned water sampling devices, wash them with Liqui-Nox (non-phosphate) detergent, rinse with deionized or distilled water, and dry the equipment prior to the next sampling season.
2. Equipment will be stored in a clean location, either by the VRMP or volunteer group, depending upon storage space availability.

**VRMP SOP-01b. Volunteer River Monitoring Program -- Acceptable Water Sampling Equipment with Associated Parameters for Sampling from Bridges, Culverts, or Boats.**

\*\*\* = For certain water samplers, a separate 2nd water sample must be collected for solids-related parameters.

Note: The mention of brand names does not constitute recommendation of a specific company. Also, "D. O." = dissolved oxygen and "Temp." = temperature.

Last modified: June 2, 2009


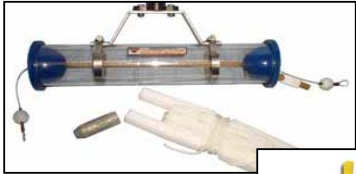


EQUIPMENT	PHOTO	EST. COST	Parameters													
			Dissolved Oxygen	Temperature	Specific Conductance	Bacteria	pH	Turbidity	Suspended Sediment Conc. (SSC)	Total Diss. Solids (TDS)	Chloride	Phosphorus (various types)	Nitrogen (various types)	Hardness	Alkalinity	Total Suspended Solids (TSS)
<p><b>MDEP Weighted Bacteria Sampler (and rope)</b></p> <p>[[Secure a sterilized bottle, or a sterile Whirl-Pak ® bag propped upright a small bottle, within the sampler; immerse upside-down in water and pull rope to turn bottle upright and fill with sample water.]]</p>		\$25			✓	✓	✓			✓	✓		✓	✓	✓	✓
<p><b>Discrete-Depth Water Sampler</b></p> <p>(Currently, either the MDEP 250-mL wide-mouth bottle modification of the Aquatic Research Instrument's (A.R.I.) D.O. water sampler for use with D.O. meters -or- A.R.I.'s or LaMotte's D.O. samplers, which use 60-mL bottles for use with D.O. kits.)</p> <p>[[For use with a D.O. probe, prop sampler upright on an upside-down bucket and insert &amp; jig D.O. probe.]]</p>		\$125 - 175	✓	✓	✓		✓	***	***	✓	✓	?	✓	✓	✓	***
<p><b>Van Dorn Sampler ("Beta" Version Sampler)</b></p> <p>[[For D.O., prop sampler upright on an upside-down bucket and insert &amp; jig D.O. probe.]]</p>		\$375	✓	✓	✓		✓	✓	✓	✓	✓	✓	✓	✓	✓	✓

**VRMP SOP-01b. Volunteer River Monitoring Program -- Acceptable Water Sampling Equipment with Associated Parameters for Sampling from Bridges, Culverts, or Boats.**

\*\*\* = For certain water samplers, a separate 2nd water sample must be collected for solids-related parameters.

**Note:** The mention of brand names does not constitute recommendation of a specific company. Also, "D. O." = dissolved oxygen and "Temp." = temperature.

Last modified: June 2, 2009

EQUIPMENT	PHOTO	EST. COST	Parameters													
			Dissolved Oxygen	Temperature	Specific Conductance	Bacteria	pH	Turbidity	Suspended Sediment Conc. (SSC)	Total Diss. Solids (TDS)	Chloride	Phosphorus (various types)	Nitrogen (various types)	Hardness	Alkalinity	Total Suspended Solids (TSS)
<b>Kemmerer Sampler</b> [[For D.O., prop sampler upright on an upside-down bucket and insert & jig D.O. probe.]]		\$475 - 500	✓	✓	✓		✓	✓	✓	✓	✓	✓	?	✓	✓	✓
<b>Van Dorn Sampler ("Alpha" --or-- "Student" Version)</b> [[For D.O., prop sampler upright on an upside-down bucket and insert & jig D.O. probe.]]	  	\$80 - 250	✓	✓	✓		✓	✓	✓	✓	✓		✓	✓	✓	✓

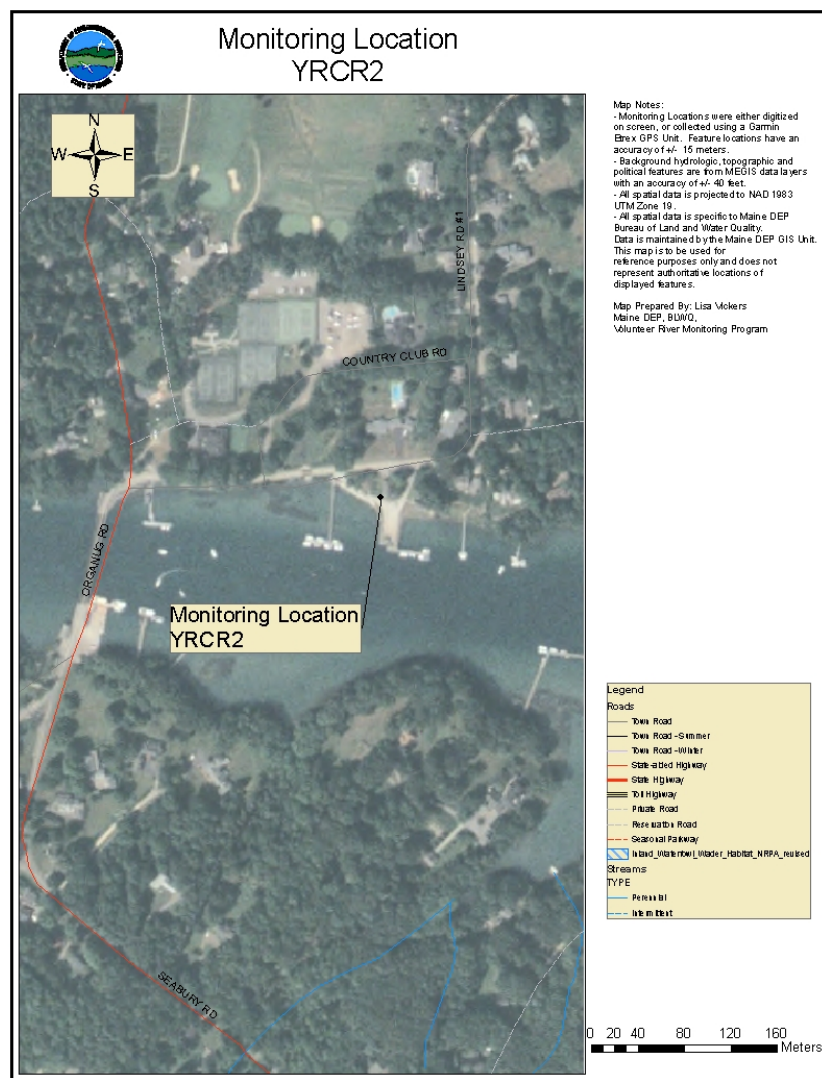




## STANDARD OPERATING PROCEDURES

### MAINE VOLUNTEER RIVER MONITORING PROGRAM (VRMP)

#### METHODS FOR SELECTING AND DOCUMENTING SITE LOCATIONS FOR VOLUNTEERS IN THE MAINE VOLUNTEER RIVER MONITORING PROGRAM



**Note:** The mention of brand names does not constitute recommendation of a specific company.



**Volunteer River Monitoring Program (VRMP)**  
**Standard Operating Procedure**  
**Methods for Selecting and Documenting Site Locations**  
**for Volunteers in the Volunteer River Monitoring Program**

**1. Applicability.** This standard operating procedure (SOP) is used by the Volunteer River Monitoring Program (VRMP) of the Maine Department of Environmental Protection's (DEP's) Bureau of Water Quality, Division of Environmental Assessment, Watershed Management Unit. It applies to locating and documenting monitoring locations as part of the VRMP.

**2. Purpose.** The purpose of this SOP is to provide standardized methods for volunteer groups to locate and document site locations that will be monitored as part of the Volunteer River Monitoring Program.

**3. Definitions.**

- A. GPS.** Global Positioning System; A satellite-based navigation system made up of a network of 24 satellites placed into orbit by the U.S. Department of Defense.
- B. GIS.** Geographic Information System; GIS is a computer system capable of capturing, storing, analyzing, and displaying geographically referenced information.
- C. SAP.** Sampling and Analysis Plan; used by volunteer groups as part of the VRMP Quality Assurance Program Plan (QAPP). It details the sampling methods and QA procedures that are to be used by the volunteer group.

**4. Responsibilities**

**A. *Volunteer Monitors & Volunteer Groups***

- **Certification.** It is the responsibility of the individual collecting this data to maintain current certification if they wish their data to be entered into the VRMP database. Training will be provided to volunteers on an annual basis by VRMP/DEP staff. Certification for certain tasks (e.g., water monitoring or sample collection) will last for one year from the date of training, while certification for other tasks (e.g., site documentation, GPS use, data management) will only need to occur on an as needed basis (as determined by VRMP staff).



- **Data Recording.** It is the responsibility of the individual obtaining this data to record the results and additional qualifying information on the current VRMP Site Description Form obtained from their affiliated watershed association or through the VRMP program of the DEP.
- **Data Quality Checks and Data Submission.** The data manager for the volunteer group will collect and enter the information from the VRMP Sampling Site Description Form (QAPP Appendix 6) into the appropriate computer file, perform quality assurance checks (Refer to Section 5.10 of the QAPP), and submit data to the VRMP following protocols outlined in the volunteer group's latest sampling and analysis plan (SAP) that has been approved by the VRMP.

#### **B. Volunteer River Monitoring Program (VRMP) Staff**

- **Oversight of Volunteer Groups and Volunteers.** VRMP staff will oversee volunteer groups and volunteers through a variety of ways including maintaining an up-to-date VRMP QAPP; reviewing SAPs of the volunteer groups; providing annual training/certification sessions for volunteers; conducting quality control checks on data submitted by volunteer groups and laboratories; and uploading data into the DEP's EGAD (Environmental and Geographic Analysis Database) database. These tasks are described in greater detail in the VRMP's latest QAPP.

### **5. Guidelines and Procedures.**

- A. Safety.** Safety hazards exist when working in the field and in or around water. Volunteers participating in the VRMP should exercise common sense and be aware of potential hazards in the field that include but are not limited to: poison ivy, ticks, mosquitoes, sun/heat, and stream dangers (e.g., slippery stream banks or stream bottoms, fast or deep flows). See QAPP Appendix 4 for more information regarding safety.

#### **B. Site Location Selection.**

- **Purpose of monitoring.** Site selection should be guided by the purpose of the monitoring plan and objectives/goals. The monitoring plan and objectives/goals shall be detailed in the specific SAP of the volunteer group.
- **Representativeness.** The site selection of the monitoring location should reflect the representativeness or environmental conditions (e.g., dominant river habitat type) of the river/stream being monitored as best as possible (though volunteer safety remains the highest priority). Try to avoid very slow moving or "backwater" type habitats.
- **Landowner permission.** If the site is located on private land, ownership of the property shall be determined and permission for access shall be obtained prior to final selection of the site as a monitoring location.



- **Access.** Volunteer groups shall ensure there is safe access to the monitoring location as well as a safe way to measure parameter(s). Sampling from a (safe) edge of the river or from a bridge (using a VRMP approved water sampling device) should be considered if local conditions are generally hazardous.
- **Final selection of sites.** Site locations should be physically surveyed to verify the aforementioned criteria and to select specific stream reaches for sampling. Volunteers are encouraged to bring along another member of their group, or VRMP staff, to assist them with appropriate site selection.

### *C. Documentation of Site Location.*

- **VRMP Site Description Form.** VRMP staff or volunteer groups should complete a VRMP Sampling Site Description Form (QAPP Appendix 6) for each site selected to document physical and geographic characteristics of the sample area and the horizontal and vertical position of the sample collection.
- **Location Coordinates.** VRMP staff or volunteer groups shall document site locations using a GPS unit. If a GPS unit is unavailable, they may document the monitoring location through other methods that include but are not limited to placing a point on an online map or indicating location on a USGS topographical map such as the Gazetteer. VRMP staff will provide assistance with GPS geographic coordinate data collection and GIS map-making to volunteer groups as needed and as time permits.
- **Physical Documentation.** Groups should document monitoring site characteristics on the Sampling Site Location Form by providing a site sketch in the space provided. In addition, any photographs taken and submitted with the Sampling Site Location Form shall be recorded on the site sketch.



## STANDARD OPERATING PROCEDURE

### MAINE VOLUNTEER RIVER MONITORING PROGRAM

#### METHODS FOR USING THE HACH HQ30d SINGLE INPUT MULTI-PARAMETER DIGITAL METER WITH THE HACH LDO101 IntelliCAL RUGGED OPTICAL DISSOLVED OXYGEN PROBE IN RIVERS AND STREAMS



**Note:** The mention of brand names does not constitute recommendation of a specific company.



## Volunteer River Monitoring Program (VRMP)

### Standard Operating Procedure

#### Methods for using the Hach HQ30d Single-Input Multi-Parameter Digital Meter with the Hach LDO101 IntelliCAL Rugged Optical Dissolved Oxygen Probe

**1. Applicability.** This standard operating procedure (SOP) is used by the Volunteer River Monitoring Program (VRMP) of the Maine Department of Environmental Protection's (DEP's) Bureau of Water Quality, Division of Environmental Assessment, Watershed Management Unit. It applies to the collection of dissolved oxygen (DO) and temperature from rivers and streams in Maine using the Hach HQ30d single-input multi-parameter digital meter with the Hach LDO101 IntelliCAL Rugged Dissolved Oxygen Probe.

**2. Purpose.** This purpose of this SOP is to provide standardized methods for volunteer groups to determine dissolved oxygen and temperature of rivers and streams as an instantaneous reading using the Hach HQ30d digital meter with the LDO101 IntelliCal Rugged Dissolved Oxygen Probe. This SOP also provides standardized methods for DEP VRMP staff to conduct quality assurance checks on volunteer groups' equipment.

#### 3. Definitions.

- A. Hach.** Manufacturer of water quality monitoring meters.
- B. Luminescent Dissolved Oxygen Sensor (LDO).** Sensor that measures the light emission characteristics of a luminescent reaction.
- C. Sensor Cap.** Removable sensing cover that protects the sensor.
- D. iButton®.** A computer chip enclosed in a 16mm thick stainless steel can that contains the calibration codes specific to individual sensor caps.
- E. Calibration.** Set of procedures established by the manufacturer to ensure that the meter is operating properly; a critical quality assurance step in meter preparation prior to use.
- F. Shroud.** A protective cover for the LDO sensor cap.

#### 4. Responsibilities.

- A. Volunteer Monitors & Volunteer Groups**



- **Certification.** It is the responsibility of the individual obtaining this data to maintain current certification for the parameter(s) they collect if they wish their data to be entered into the VRMP database. Training will be provided to volunteers on an annual basis by VRMP/DEP staff, and certification will last for one year from the date of training.
- **Data Recording.** It is the responsibility of the individual obtaining this data to record the results and additional qualifying information on current field sheets obtained from their affiliated watershed association or through the VRMP program of the DEP.
- **Data Quality Checks and Data Submission.** The data manager for the volunteer group will collect and enter volunteer field sheet data onto the appropriate computer file, perform quality assurance checks (refer to Section 5.10 of the Quality Assurance Program Plan), and submit data to the VRMP following protocols outlined in the volunteer group's latest sampling and analysis plan (SAP) that has been approved by the VRMP.

#### ***B. Volunteer River Monitoring Program (VRMP) Staff***

- **Oversight of Volunteer Groups and Volunteers.** VRMP staff will oversee volunteer groups and volunteers through a variety of ways including maintaining an up-to-date VRMP quality assurance program plan (QAPP); reviewing sampling and analysis plans (SAPs) of the volunteer groups; providing annual training/certification sessions for volunteers; conducting quality assurance checks on volunteer data collection and data submitted by volunteer groups and laboratories; and uploading data into the DEP's EGAD (Environmental and Geographic Analysis Database) database. These tasks are described in greater detail in the VRMP's latest QAPP.

### **5. Guidelines and procedures.**

#### ***A. Hach HQ30d Meter Preparation.***

- **First time use.** Follow manufacturer's instructions for preparing meter for first time use. (refer to Appendix A; Section 3: Installation, pgs. 11-17 and Section 4: System Start Up, pgs. 19 – 23).
  - *Note of Caution:* Before attaching the LDO probe for the first time, set the date and time in the meter. If the meter data and time are incorrect when the probe is installed, the probe will retain this incorrect time stamp for the remainder of its service life. (Refer to Appendix A, Section 4.4: Setting the Date and Time, pg. 22).
  - If you plan to use the data storage features of the meter (in addition to manually writing down data on the VRMP field data sheet), then familiarize yourself with Appendix A, Section 5: Standard Operation, pgs. 25-45.



- **Beginning of field season.** Before each field season, volunteer monitoring groups shall conduct a full inspection of the meter. A new sensor cap, iButton® and batteries shall be installed prior to the start of field sampling and additionally, as needed. Refer to Appendix C for details on sensor cap and iButton® replacement (pgs. 3 – 7).
  - *Note of Caution:* Only use optical tissue or cotton swabs and soapy water to clean the sensor cap. Do not use organic solvent solutions such as acetone or methanol with the LDO101 sensor cap and do not scrub the sensor cap or the sensor lens.In addition, each meter “setup” should be equipped with the following items so that field repairs can be undertaken as necessary:
  - Extra batteries
  - Field data sheet
  - Pencil with eraser
  
- **Prior to field sampling.** Before each field sample collection, the volunteer shall inspect the meter including an inspection of the condition of the sensor cap and batteries.
  - (1) Batteries should be checked for charge and/or expiration.
  - (2) Ensure that there is no water present between the sensor cap and the clear plastic sensor lens at the top of the probe (Refer to Appendix B, Section “Maintenance”, pg. 4)
  - (3) Be familiar with the testing, inspection, maintenance, and calibration considerations described in sections 5.6 through 5.8 of the VRMP QAPP (MDEP, 2009).
  
- **Dissolved Oxygen Calibration.** The Hach HQ30d meter and LDO probe are factory-calibrated. For best performance, a one-time calibration initialization can be performed when a new sensor is installed. Additionally, calibrations can be performed at the operator’s discretion but are not required. Ensure that the shroud is removed prior to calibrating the probe (Refer to Appendix B, “Removing and Replacing the Shroud, pgs. 2 – 3).

Calibration can be performed manually using one of two standards: Water saturated air (manufacturer recommended) or calibration to a solution with a known DO concentration (usually determined by a Winkler Titration). Note: VRMP staff has found that a water saturated air sample method provides the best results.

- *For the annual standardization & calibration of VRMP staff “benchmark” Hach HQ30D meters and LDO101 probes for use in accuracy-checking of equipment at volunteer certification workshops. VRMP staff will follow the instructions in Appendix A, Section 8.2: Calibrating the LDO Probe (pgs.79 – 81). VRMP staff will obtain the ‘Winkler titration method’ measurements of the dissolved oxygen concentration of the test water sample using the*





laboratory-grade Winkler titration setup at DEP facilities in Augusta. This data obtained using the Winkler setup will be used as the calibration/standardization value that is entered into the Hach HQ30D meter annually.

- *For general purpose use of the Hach HQ30D meter and LDO101 probe.* Hach recommends meter calibration using the DO % water-saturated-air calibration. (For instructions, refer to Appendix A, Section 8.2: Calibrating the LDO Probe, pgs. 79 - 81). For best performance, a one-time calibration initialization can be performed when a new sensor is installed. Additional calibrations can be performed at the operator's discretion but are not required.
  - A count down message appears on the screen 30 days before the sensor-cap expiration date of the LDO IntelliCAL probe. This message will be displayed until there are zero days remaining and the sensor cap must be replaced. All measurements taken after the sensor cap expiration date appear with the calibration ? icon at the top left corner of the screen.

### ***B. Dissolved Oxygen and Temperature Measurements.***

- **Sampling Period and Site Location.** Sampling period and site location information will be documented in the volunteer groups' SAPs (that require approval by the VRMP) which are submitted by the volunteer groups prior to any sampling. (Detailed information regarding how volunteer groups are to obtain and document site location information can be found in VRMP SOP-02 [Documenting Site Location].)
- **Sample Timing.** Dissolved oxygen data collected between dawn and 8 am are important for assessment of attainment of DO criteria within Maine's Water Quality Standards. But, except as naturally occurs, DO concentrations below the applicable DO criteria at any time of day signal non-attainment. If there are no DO concentrations below the criteria after 8 am, then data between dawn and 8 am must be collected to assess attainment of the criteria.
- **Re-Familiarize Yourself with the Meter and its User Manual.** Familiarize yourself with the meter, including Appendix A, Section 1: General Information, pgs. 7-8, Section 3: Installation, pgs. 11 - 16, and Section 4: System Start Up, pgs. 19 - 22.
- **General Sampling Protocol.**
  - Record site location on data sheet.
  - Remove probe from calibration/storage sleeve.
  - Submerge probe in the water at the site where you are monitoring, as described in your group's approved SAP.
  - For any of the parameters measured, allow the reading to stabilize (at least 30 seconds) before recording the value on the field sheet.
  - Follow the instructions below measuring specific parameters.



- Since there is no warm-up period associated with the Hach HQ30D meter and LDO probe and because the calibration is stable, you may wish to turn off the instrument between readings to conserve battery power.

- **Dissolved Oxygen Measurements.**

- (1) Review and follow the instructions for making DO measurements in Appendix A, Section 8.1: Taking a Dissolved Oxygen Measurement, pg.79.
- (2) Refer to instructions regarding display of units (e.g., mg/L, ppm, or DO % [% saturation]) in Appendix A, Subsection 8.4.4: Modifying the LOD Measurement Units, pg. 86.
- (3) In most cases, only a limited amount of initial probe movement in the water is required for taking measurements (as opposed to older styles of dissolved oxygen meters which require continuous flow or movement across their membranes).

- **Temperature Measurements.**

- (1) Temperature will display when taking Dissolved Oxygen measurements. Refer to Appendix A, Section 8.1: Taking a Dissolved Oxygen Measurement, pg. 79.
- (2) For information on how to change units, refer to Appendix A, Section 9.10: Changing the Temperature Units, pg. 99.

- **Quality Control.**

- (1) At the beginning of each field season, all VRMP staff and VRMP volunteers who collect dissolved oxygen and temperature data will have a training/refresher/certification session to (re)familiarize themselves with the contents of this SOP.
- (2) For every volunteer, a field duplicate shall be obtained for all parameters for at least 10% of their own sampling efforts. A field duplicate will be collected for every 10 samples monitored.
- (3) Refer to the VRMP quality assurance project plan (QAPP) for more QA/QC details.

## 6. Equipment Care.

### A. *Start of field season.*

1. Follow manufacturer's directions for preparation of a new probe or renewing probe in the spring. Be sure to replace sensor cap at the start of each sampling season. (Refer to Appendix C, LDO Sensor Replacement Kit, pgs. 3 - 7).
  - *Note of caution:* Avoid handling the black face of the sensor cap. DO NOT use alcohol or other organic solvents to clean the black face of the sensor cap. These solvents will destroy the sensor cap.
2. Use new batteries at start of each sampling season. An extra set of appropriate size batteries should be included in the meter carrying case.



3. Each DO meter should have the spare items for making repairs in the field. See section 5-A of this SOP for a list of necessary items.

***B. Field Season***

1. Ideally the meter should be in water-resistant case with padding to protect it from damage.
2. Allow the case and contents to air-dry at end of each day. This may be accomplished by simply propping the lid open. When contents are very wet, remove the contents and spread out to facilitate drying.
3. Keep meter from freezing.
4. Refer to Appendix A, Section 10: Maintenance, pg. 101 and Appendix B, Section, “Maintenance”, pg. 4 for manufacturer’s recommendations for maintenance requirements.

***C. End of field season***

1. Completely dry meter, case, and all items in the case before storing.
2. Remove batteries.
3. Keep meter dry and at room temperature to prevent corrosion of electronic parts. The Hach HQ30D and IntelliCAL LDO probe should be stored between -20° C to 60° C.
4. Record winterization date and equipment repairs in your volunteer group’s Equipment Log.
5. Label the meter and case as ‘WINTERIZED’ in an obvious manner (so users will know the current status of the unit).

**7. Specifications**

<b>Measurement</b>	<b>Range</b>	<b>Resolution</b>	<b>Accuracy</b>
Temperature	0°C - 50 °C	0.1 °C	±0.3 °C
Dissolved Oxygen	1 – 200% saturation	0.01 mg/L	± 0.1 mg/L for 0.1 – 8 mg/L
	0.1 – 20.0 mg/L (ppm)		± 0.2 mg/L for greater than 8.0 mg/L



## 8. Appendices.

### A. *Hach Meter and Probe owner's manual:*

Hach. 2006. Hach HQ Series Portable Meters User Manual. Loveland, Colorado.

### B. *Hach Probe Instruction Sheet:*

Hach. 2006. Hach LDO101-05, LDO101-10, LDO101-15, or LDO101-30 Probe Instruction Sheet. Loveland, Colorado.

### C. *Hach LDO™ Sensor Replacement Kit:*

Hach. 2006. Hach LDO™ Sensor Replacement Kit, for use with Hach LDO101 Standard and Rugged Dissolved Oxygen Probes User Manual. Loveland, Colorado.

## 9. References

### A. *DEP Standard Operating Procedures:*

- Document number #:DEPLW-0890: Dissolved Oxygen and Temperature, Instantaneous Measurement using Electronic Meters

### B. *Maine VRMP QAPP:*

- Maine Department of Environmental Protection (MDEP). 2020. Maine Volunteer River Monitoring Program (VRMP) Quality Assurance Program Plan (VRMP). Portland, ME. Document number#: DEPLW-0984.



Catalog Number HQ40d18

# **HQ Series Portable Meters**

USER MANUAL

September 2006, Edition 5



<b>Section 1 General Information</b> .....	7
1.1 Safety Information .....	7
1.1.1 Use of Hazard Information .....	7
1.1.2 Precautionary Labels .....	7
1.2 Product Overview .....	8
1.3 Meter Description .....	8
<b>Section 2 Specifications</b> .....	9
<b>Section 3 Installation</b> .....	11
3.1 Unpacking the Instrument .....	11
3.2 AC Power and Batteries .....	12
3.2.1 Battery Power .....	12
3.2.2 AC Power .....	14
3.3 Turning the Meter On and Off .....	14
3.4 Probe Connection .....	14
3.5 Data Transfer .....	16
<b>Section 4 System Start Up</b> .....	19
4.1 Basic Start Up Overview .....	19
4.2 Meter User Interface and Navigation .....	20
4.2.1 Keypad Description .....	20
4.2.2 Display Description (Single and Dual) .....	21
4.2.2.1 Using Single Screen Mode .....	21
4.2.2.2 Using Dual Screen Mode (HQ40d only) .....	21
4.3 Selecting the Language .....	22
4.4 Setting the Date and Time .....	22
<b>Section 5 Standard Operation</b> .....	25
5.1 Setting the Sample and Operator Identification .....	25
5.1.1 Sample ID .....	25
5.1.1.1 Creating a New Sample ID .....	25
5.1.1.2 Selecting a Sample ID .....	26
5.1.1.3 Deleting a Sample ID .....	26
5.1.2 Operator ID .....	27
5.1.2.1 Creating a New Operator ID .....	27
5.1.2.2 Selecting an Operator ID .....	27
5.1.2.3 Deleting an Operator ID .....	28
5.2 Using the Data Log .....	28
5.2.1 Storing Data .....	28
5.2.2 Viewing Stored Data .....	28
5.2.3 Viewing Probe Data .....	29
5.2.4 Deleting Data .....	30
5.3 Transferring Data .....	31
5.3.1 Transferring Data Options .....	31
5.3.1.1 Selecting Printed Report Types .....	31
5.3.1.2 Including Column Headers in Data Files .....	32
5.3.2 Sending Data to a Printer .....	33
5.3.3 Sending Data to a Flash Memory Stick .....	33
5.3.4 Sending Data to a Computer using the HQd PC Application Software .....	34
5.3.5 Sending Probe Calibration Data .....	35
5.4 Viewing Printed Data Log Reports .....	36
5.4.1 Report Names .....	36
5.4.2 Sample Results .....	36
5.4.2.1 Basic Reports .....	36

## Table of Contents

---

5.4.2.2	Advanced Reports	37
5.4.2.3	Total Reports	37
5.4.3	Calibration Results	38
5.4.4	Check Standard Results	39
5.5	Viewing Printed Calibration Reports	40
5.5.1	Current Calibration Reports	40
5.5.2	Calibration History Reports	41
5.6	Viewing Downloaded Data Files	42
5.7	Archiving and Exchanging User Methods	45
<b>Section 6</b>	<b>pH Operation and Methods</b>	<b>47</b>
6.1	Calibrating the pH Probe	47
6.1.1	Calibration Errors	48
6.1.1.1	Standard Not Recognized	48
6.1.1.2	Slope Error	48
6.2	Taking a pH Measurement	49
6.3	Running Check Standards	49
6.3.1	Automatic or Custom Check Standards	49
6.3.2	Measuring Check Standards	50
6.3.3	Deferring a Check Standard	51
6.4	Setting the pH Method	51
6.5	Modify Current Method Menu for pH Summary	52
6.5.1	Modifying pH Methods	53
6.5.2	Modifying the pH Measurement Options	53
6.5.3	Modifying the pH Calibration Options	55
6.5.4	Modifying the pH Check Standard Options	59
6.5.4.1	Selecting a Check Standard Buffer	59
6.5.4.2	Using a Custom Check Standard	59
6.5.4.3	Editing the Check Standard Reminder Options	60
6.5.4.4	Editing the Acceptance Criteria for Check Standards	61
6.5.5	Modifying the pH Measurement Units	62
<b>Section 7</b>	<b>Conductivity Operation and Methods</b>	<b>63</b>
7.1	Calibrating the Conductivity Probe	63
7.2	Taking a Conductivity, Salinity, Resistivity, or TDS Measurement	64
7.3	Running Check Standards Manually or Automatically	65
7.3.0.1	Deferring a Check Standard	66
7.4	Setting the Conductivity Method	66
7.5	Modify Current Method Menu for Conductivity Summary	67
7.5.1	Modifying a Conductivity Method	68
7.5.2	Modifying the Conductivity Parameter	68
7.5.3	Modifying the Conductivity Measurement Options	69
7.5.4	Modifying the Conductivity Calibration Options	72
7.5.5	Modifying Conductivity Check Standard Options	75
<b>Section 8</b>	<b>LDO Operation and Methods</b>	<b>79</b>
8.1	Taking a Dissolved Oxygen Measurement	79
8.2	Calibrating the LDO Probe	79
8.2.1	Calibration Error- Slope Out of Range	81
8.3	Setting LDO Methods	81
8.4	Modify Current Method Menu Summary	82
8.4.1	Entering a New LDO Method	82
8.4.2	Modifying an LDO Method	83
8.4.3	Modifying LDO Measurement Options	83
8.4.4	Modifying the LDO Measurement Units	86



8.4.5 Modifying the LDO Calibration Standard .....	86
8.4.5.1 Selecting Water-Saturated Air as the Calibration Standard .....	86
8.4.5.2 Selecting a Water Sample as the Calibration Standard .....	87
8.4.6 Selecting a LDO Method .....	88
8.4.7 Deleting a Method .....	89
<b>Section 9 Advanced Operations .....</b>	<b>91</b>
9.1 Meter Options Menu- Full Access .....	91
9.2 Operator Meter Options Menu .....	91
9.3 Using Access Control .....	92
9.3.1 Turning Access Control On .....	92
9.3.2 Turning Access Control Off .....	93
9.4 Running Check Standards .....	93
9.5 Setting the Measurement Mode .....	94
9.5.1 Setting Auto Measurement Intervals .....	95
9.5.2 Starting Interval Measurements .....	96
9.5.3 Preventing Data Log Overflow in Interval Reading Mode .....	96
9.6 Viewing Instrument Information .....	97
9.7 Setting the Display Options .....	97
9.8 Setting the Sound Options .....	98
9.9 Setting the Date and Time .....	99
9.10 Changing the Temperature Units .....	99
9.11 Language .....	99
<b>Section 10 Maintenance .....</b>	<b>101</b>
10.1 General Meter Cleaning .....	101
10.2 General Probe Cleaning .....	101
10.3 Battery Replacement .....	101
10.4 Updating Instrument Software .....	101
<b>Section 11 Parts and Accessories .....</b>	<b>103</b>
11.1 Parts .....	103
11.2 Accessories .....	103
11.3 Consumables .....	104
<b>Section 12 How to Order .....</b>	<b>107</b>
<b>Section 13 Repair Service .....</b>	<b>109</b>
<b>Section 14 Certification .....</b>	<b>111</b>
<b>Section 15 Limited Warranty .....</b>	<b>113</b>
<b>Appendix A Connecting the Citizen Handy Printer PD-24 .....</b>	<b>115</b>
<b>Index.....</b>	<b>117</b>



# Section 1 General Information

---

## 1.1 Safety Information

Please read this entire manual before unpacking, setting up, or operating this equipment. Pay attention to all danger and caution statements. Failure to do so could result in serious injury to the operator or damage to the equipment.

To ensure that the protection provided by this equipment is not impaired, do not use or install this equipment in any manner other than that specified in this manual.

### 1.1.1 Use of Hazard Information

#### **DANGER**

**Indicates a potentially or imminently hazardous situation which, if not avoided, could result in death or serious injury.**

#### **CAUTION**




**Indicates a potentially hazardous situation that may result in minor or moderate injury.**

**Important Note:** Information that requires special emphasis.

**Note:** Information that supplements points in the main text.

### 1.1.2 Precautionary Labels

Read all labels and tags attached to the instrument. Personal injury or damage to the instrument could occur if not observed. A symbol, if noted on the instrument, will be included with a danger or caution statement in the manual.

	This symbol, if noted on the instrument, references the instruction manual for operation and/or safety information.
	Electrical equipment and manufacturer supplied accessories marked with this symbol may not be disposed of in European public disposal systems after 12 August of 2005. In conformity with European local and national regulations (EU Directive 2002/96/EC), European electrical equipment users must now return old or end-of life equipment to the Producer for disposal at no charge to the user. <b>Note:</b> For return for recycling, please contact the equipment producer or supplier for instructions on how to return end-of-life equipment, producer-supplied electrical accessories, and all auxiliary items for proper disposal.
	This symbol, if noted on the product, indicates the need for protective eye wear.

### 1.2 Product Overview

The HQ Series Portable Meters measure various parameters when used with IntelliCAL™ probes such as pH, conductivity, salinity, total dissolved solids (TDS), or dissolved oxygen (using Hach's patented luminescent dissolved oxygen probes, LDO®). The meter automatically recognizes the type of probe that is connected to the meter. IntelliCAL probes store the unique serial number, current calibration, and calibration history. When the default settings are used, an operator can take measurements right out of the box.

Data is easily managed by using the settings for operator ID, sample ID, and data storage. Supervisory control can be set by using the access function. Settings for measurement and calibration are stored as methods. The default method for each parameter follows suggested USEPA measurement techniques.

### 1.3 Meter Description

The HQ series meters are available in four models:

- **HQ11d**—pH/mV
- **HQ14d**—conductivity, salinity, total dissolved solids (TDS)
- **HQ30d**—pH, conductivity, salinity, total dissolved solids (TDS) or dissolved oxygen (LDO), 1 probe connector
- **HQ40d**—pH, conductivity, salinity, total dissolved solids (TDS), or dissolved oxygen (LDO), 2 probe connectors.

Other features:

- Auto probe recognition including serial number
- Methods containing parameter settings for regulatory control
- Supervisory access control
- Long sensor life, LDO
- No polarization time, LDO
- Internal data storage of 500 results
- Sample ID and Operator ID for data traceability
- Adjustable automatic shut-off for extended battery life
- Automatic correction for barometric pressure and temperature, LDO
- IP67 (waterproof to 1 meter for 30 minutes, excluding battery housing. Battery compartment submersible to 2 feet for 15 seconds)
- Connectivity to PC/printer/flash memory stick/keyboard
- Power from four alkaline or Nickel Metal Hydride (NiMH) AA batteries, or AC adapter

## Section 2 Specifications

Specifications are subject to change without notice.

<b>Meter Enclosure</b>	
Enclosure	Meter: IP67, waterproof to 1 meter for 30 minutes Battery Compartment: water resistant to 2 feet for 15 seconds
Power Requirements (internal)	AA Alkaline or Nickel Metal Hydride (NiMH) Batteries (4)
Power Requirements (external USB/DC power adaptor)	100–240 V, 50/60 Hz input; 4.5 to 7.5 V (7 VA) output (center contact +, outer shield -)
Storage Temperature	–20 to +60 °C (–4 to +140 °F)
Operating Temperature	0 to +60 °C (32 to 140 °F)
Operating Humidity	90% (non-condensing)
Weight	0.75 lb/11.6 oz/330 g 0.95 lb/15.2 oz/430 g (with four AA alkaline batteries installed)
<b>Inputs</b>	
5-pin Custom M-12 for probes	Meters accept IntelliCAL probes (HQ11d pH only; HQ14d conductivity only)
8-Pin Connector for USB and external AC power	The 8-pin connector enables USB and external AC power connectivity
<b>pH IntelliCAL Probes (standard and rugged)</b>	
pH Range	PHC301 (refillable): 0.0–14.0 pH
	PHC101 (gel filled): 2.0–14.0 pH
Sodium (Alkalinity) Error	–0.6 pH at pH 12.6 in 1 M NaOH
Temperature Range	0.0–80.0 °C
Temperature Accuracy	±0.3 °C
Warranty	PHC301 probe is covered by a one-year warranty PHC101 probe is covered by a six-month warranty
<b>LDO IntelliCAL Probes (standard and rugged)</b>	
Dissolved Oxygen Range	0.1–20.0 mg/L (ppm) 1–200% saturation
Dissolved Oxygen Accuracy	±0.1 mg/L for 0.1–8 mg/L ±0.2 mg/L for greater than 8.0 mg/L
% Saturation	1.0%
Temperature Range	0–50 °C
Temperature Resolution	0.1 °C
Temperature Accuracy	± 0.3 °C
Warranty	Probe is covered by a three-year warranty. Sensor cap is covered by a one-year warranty.
<b>Conductivity IntelliCAL Probe</b>	
Conductivity Range	0.01 µS/cm to 200.0 mS/cm
Conductivity Resolution	0.01–19.99 µS/cm: 0.01 µS/cm 20.0–199.9 µS/cm: 0.1 µS/cm 200.0–1999.0 µS/cm: 1.0 µS/cm 2.0–19.99 mS/cm: 0.01 mS/cm 20.0–200.0 mS/cm: 0.1 mS/cm
Conductivity Accuracy	±0.5% of Reading
TDS Range	0 to 50,000 mg/L as NaCl
TDS Accuracy	±0.5% of Reading

## Specifications

<b>Conductivity IntelliCAL Probe (continued)</b>	
TDS Resolution	0.0–199.9 mg/L: 0.1 mg/L 200.0–1999.0 mg/L: 1.0 mg/L 2.0–19.99 g/L: 0.01 g/L 20.0–50.0 g/L: 0.1 g/L
Salinity Range	0 to 42 ppt (‰)
Salinity Accuracy	±0.1 ppt
Salinity Resolution	0.01 ppt
Temperature Range	–10.0 to 110.0 °C
Temperature Accuracy	±0.3 °C
Warranty	Probe is covered by a one-year warranty.
<b>Outputs</b>	
USB	Peripheral and Host

# Section 3 Installation

## 3.1 Unpacking the Instrument

Remove the instrument and accessories from the shipping container and inspect each item for damage. Verify that all items listed on the packing slip are included. If any items are missing or damaged, contact the manufacturer or distributor (outside US).

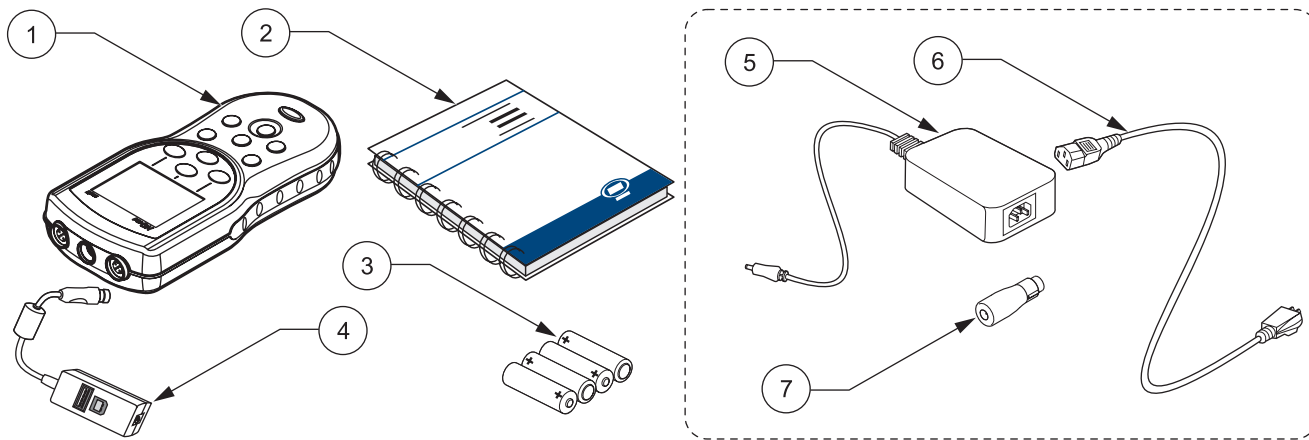


Figure 1 HQ11d, HQ14d, HQ30d Instrument Components

1	HQd Meter	5	AC-DC Power Supply (optional) <sup>1</sup>
2	User Manual (Cat. No. HQ40d18)	6	AC Power Cord (optional) <sup>1</sup>
3	AA Batteries (4) (Cat. No. 19380-04)	7	DC Power Adapter (optional) <sup>1</sup>
4	USB/DC Power Adapter (optional) (Cat. No. 58134-00)		

<sup>1</sup> Included in optional AC Power Adapter Kit (Cat. No. 58263-00 for 115 VAC or 58311-00 for 230 VAC).

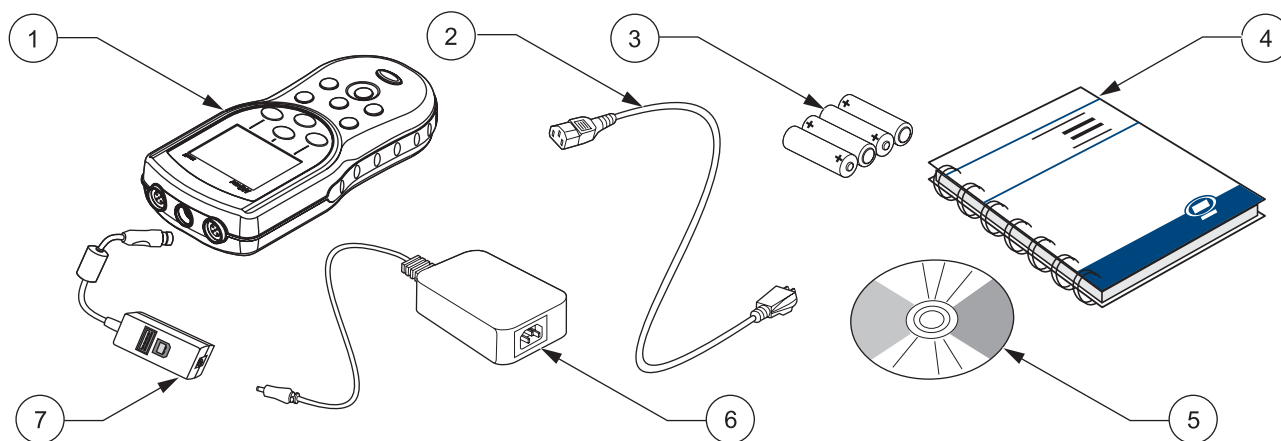


Figure 2 HQ40d Instrument Components

1	HQ40d Meter	5	PC Application Software (Cat. No. HQ40d45)
2	AC Power Cord (Cat. No. 18010-00 for 115 VAC; Cat. No. 46836-00 for 230 VAC)	6	AC-DC Power Supply (Cat. No. 58270-00)
3	AA Batteries (4) (Cat. No. 19380-04)	7	USB/DC Power Adapter (Cat. No. 58134-00)
4	User Manual (Cat. No. HQ40d18)		

### 3.2 AC Power and Batteries

**DANGER**

*Use only alkaline or nickel metal hydride type batteries in the meter. Other battery types might cause a fire or explosion.*

**DANGER**

*Make sure that the batteries are installed according to the polarity markings in the meter battery compartment. Failure to correctly install the batteries can result in damage to the meter, fire, or explosion.*

**DANGER**

*AC mains outlets in wet or potentially wet locations **MUST ALWAYS** be provided with a Ground Fault Circuit Interrupting (GFCI/GFI) circuit breaker. The AC-DC power adapter provided with this product is not sealed and must not be used on wet benches or in wet locations without GFCI protection.*

**CAUTION**

*Never mix battery types in the meter. Use four AA alkaline, or four AA nickel metal hydride batteries.*

**Important Note:** *The battery compartment of the meter and the USB/DC power adapter are not waterproof. Use care when operating these devices on a bench in wet environments. Water may infiltrate these devices and eventually cause performance or quality problems. Periodic inspection of the batteries and battery compartment is recommended, if the meter is used in wet environments: remove, clean, and dry the batteries, the interior of the battery compartment, and the battery contacts; then reinsert the batteries and close the compartment cover.*

The meter can be battery powered using four AA batteries (alkaline or nickel metal hydride) or by AC power. Connection to AC power requires additional components ([section 3.2.2 on page 14](#)).

#### 3.2.1 Battery Power

**Important Note:** *Rechargeable alkaline or nickel metal hydride batteries may also be used in the meter (do not mix battery types). Batteries are not charged in the meter.*

1. Pull the release tab on the battery cover and remove the cover as shown in [Figure 3](#).
2. Insert four AA batteries (alkaline or nickel metal hydride) following polarity markings inside the battery housing.
3. Replace the battery cover.



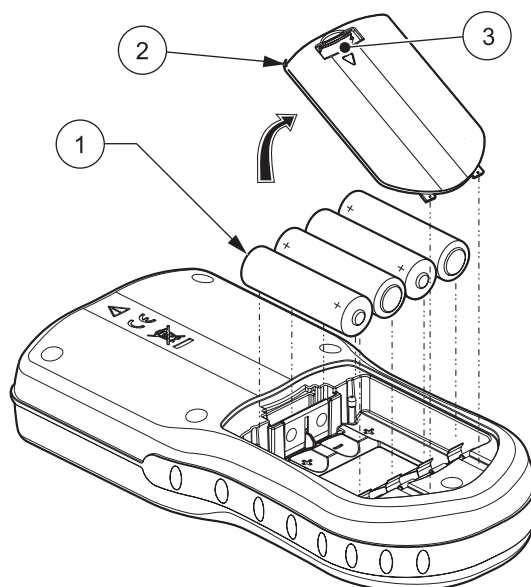


Figure 3 Battery Installation

1 AA Alkaline or Nickel Metal Hydride Battery (4) (Do not mix battery types.)	3 Release Tab
2 Battery Cover	



A battery icon appears in the top right corner of the display to indicate current battery status.

When batteries are installed, the meter will automatically shut off after five minutes of sitting idle (this is the default setting). This auto shut-off feature can be changed in the Display Options menu (see [section 9.7 on page 97](#)).

**Note:** When using nickel metal hydride (NiMH) batteries, the battery icon will not indicate a full charge after freshly charged batteries have been inserted (NiMH batteries are 1.2 V versus 1.5 V for alkaline batteries). Even though the icon does not indicate complete battery charge, if you use 2500 mAh NiMH batteries you will achieve 90% of instrument operation lifetime (before you need to recharge) versus new alkaline batteries.

**Note:** NiMH batteries self-discharge during storage. If you do not insert freshly charged NiMH batteries, operational lifetime will be reduced from this 90%.

**Note:** As batteries age, their output voltage decreases. Whenever battery voltage drops below 4-volts, the meter will shut itself down, to assure no loss of data. Insert fresh batteries and meter functionality will be restored.

### 3.2.2 AC Power

All meters can be powered by AC power using a power supply, adapter, and cord. The HQ40d meter ships with an AC-DC power supply, a USB/DC power adapter, and a power cord (see [Figure 6 on page 17](#)). The USB/DC power adaptor allows the meter to transfer data to a computer or flash memory stick ([section 3.5 on page 16](#)).

The HQ30d, HQ11d, and HQ14d meters can be powered by AC power using optional AC power adapter kits (Cat. No. 58263-00 for 115 VAC or 58311-00 for 230 VAC). Both kits include an AC-DC power supply, a DC power adapter, and a power cord. ([Figure 1 on page 11](#)).

### 3.3 Turning the Meter On and Off

***Note:** The meter can be operated in several different languages. When the meter is turned on for the first time, the user must select a language before any other meter functions can be accessed. Additionally, the operator is prompted to enter the correct time and date during initial use, and to verify correct time and date whenever the batteries are changed. See [section 4.3 on page 22](#).*

Press the power **ON/OFF** key to turn the meter on. If the meter does not turn on, be sure the batteries are installed properly or that the AC-DC power supply is connected properly to an electrical outlet.

Press the power **ON/OFF** key to turn the meter off. When batteries are used, the display backlight will turn off after 1 minute, and the meter will automatically turn off after 5 minutes (default settings). These features can be changed in the Meter Options>Display Options>Auto Shut Off/Backlight menus.

### 3.4 Probe Connection

**CAUTION**  
**BEFORE ATTACHING THE PROBE FOR THE FIRST TIME: Set the date and time in the meter before attaching the IntelliCAL probe for its first use. If the meter date and time are incorrect when the probe is installed, the probe will retain this incorrect time stamp for the remainder of its service life, even if the meter time and date have subsequently been corrected.**

The HQ11d, HQ14d, and the HQ30d support single connection and display of IntelliCAL™ probes (see [Figure 4](#)).

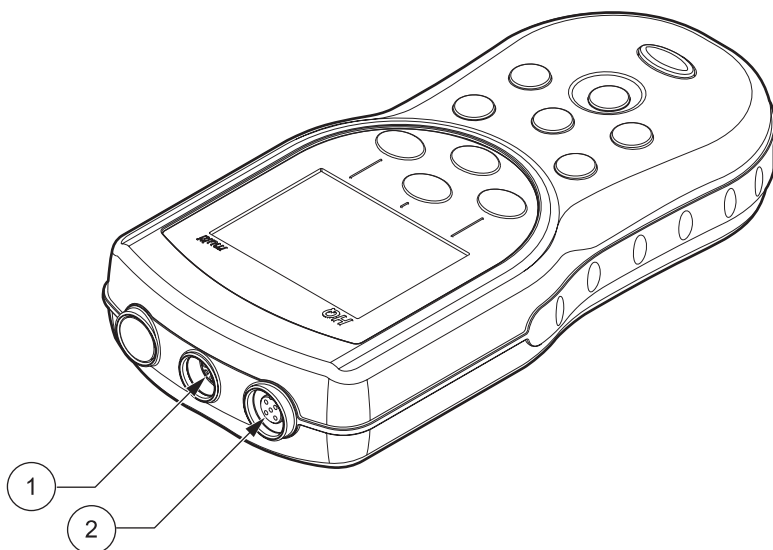


Figure 4 Connectors on HQ11d, HQ14d, HQ30d Meters

1 USB/DC Power Adapter Port (8-pin)	2 Probe Port (5-pin)
-------------------------------------	----------------------

The HQ40d supports dual connection and display of IntelliCAL™ probes (see [Figure 5](#)).

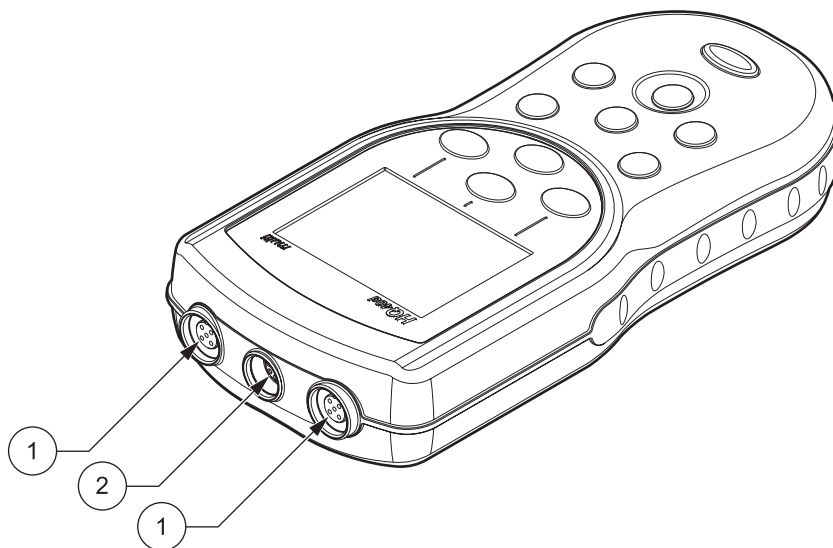
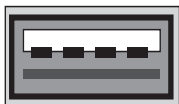


Figure 5 Connectors on HQ40d Meter

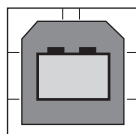
1 Probe Port (5-pin)	2 USB/DC Power Adapter Port (8-pin)
----------------------	-------------------------------------

### 3.5 Data Transfer

**Important Note:** The battery compartment of the meter and the USB/DC power adapter are not waterproof. Use care when operating these devices on a bench in wet environments. Water may infiltrate these devices and eventually cause performance or quality problems. Periodic inspection of the batteries and battery compartment is recommended, if the meter is used in wet environments: remove, clean, and dry the batteries, the interior of the battery compartment, and the battery contacts; then reinsert the batteries and close the compartment cover.



USB - Peripheral



USB - Host

Data can be transferred to a PC, printer, or flash memory stick by using the USB/DC power adapter. Refer to [Figure 6](#) for USB/DC power adapter connections.

The USB peripheral connector on the USB/DC power adapter is used for data transfer to a flash memory stick or printer. The flash stick can be connected to a PC for data transfer.

The USB host connector on the USB/DC power adapter is used for direct connection to a PC using a standard USB cable. The HQ40d Application Software must be installed onto a PC for direct communication with the meter. Start the Application Software to transfer data.

To conserve battery life, USB functionality is enabled only when the meter is initially turned on and remains connected to AC power.

To enable USB:

1. Turn the instrument off.
2. Connect the USB/DC power adapter to the instrument.
3. Plug the AC power cord into the AC-DC power supply. Connect the power output jack from the AC-DC power supply to the USB/DC power adapter.
4. Plug the AC power cord into an AC receptacle.
5. Turn on the instrument and plug in the desired USB device (refer to [Figure 6](#)).

See [section 5.3 on page 31](#) for more information on data transfer.

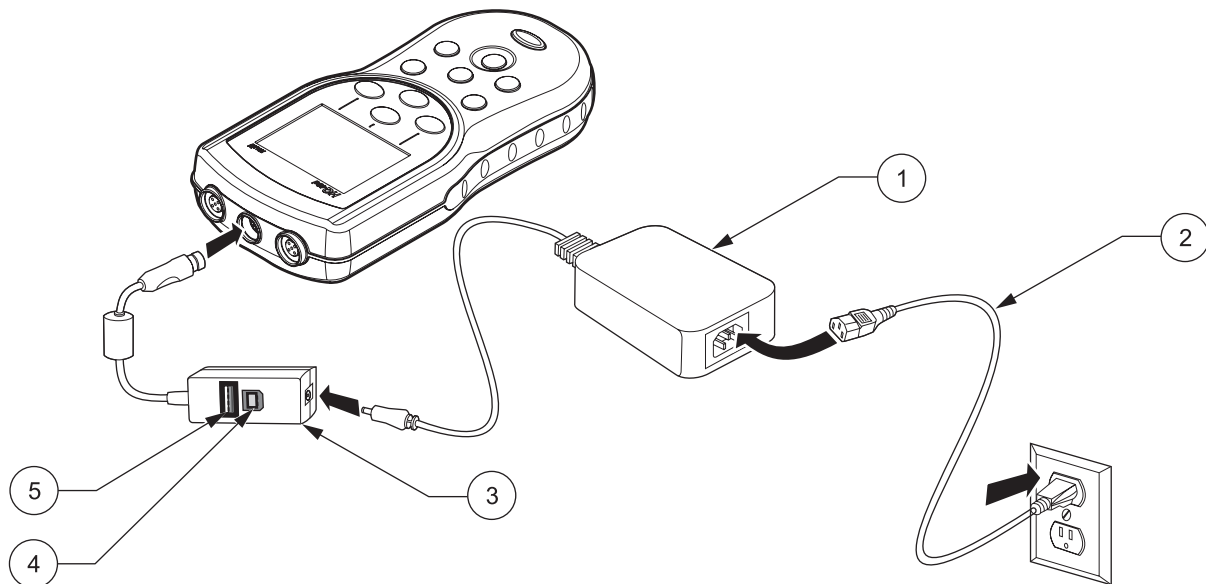


Figure 6 USB/DC Power Adapter Connections for Data Transfer

1	AC-DC Power Supply	4	Personal Computer Connection (USB Host)
2	AC Power Cord	5	Flash Memory Stick/Printer Connection (USB Peripheral)
3	USB/DC Power Adapter		



# Section 4 System Start Up

---

## 4.1 Basic Start Up Overview

1. Install batteries, close the battery compartment door and power on the meter.
2. Select the language to display on the screen. Refer to [section 4.3 on page 22](#).
3. Set the date and time. Refer to [section 4.4 on page 22](#).
4. Set the Sample and Operator IDs. Refer to [section 5.1 on page 25](#).
5. Connect the probe to the meter.

When an IntelliCAL probe is connected to a HQ30d or HQ40d meter, the meter automatically recognizes the parameter and is ready for use. The HQ11d measures only pH/mV. The HQ14d measures only conductivity, salinity, and total dissolved solids (TDS).

6. Calibrate the probe.
  - pH Probe, [section 6.1 on page 47](#)
  - Conductivity Probe, [section 7.1 on page 63](#)
  - LDO Probe, [section 8.2 on page 79](#) or use factory-default setting
7. Take a measurement reading.
  - pH Probe, [section 6.2 on page 49](#)
  - Conductivity Probe, [section 7.2 on page 64](#)
  - LDO Probe, [section 8.1 on page 79](#)
8. Run Check Standards (pH and Conductivity only).
  - pH Probe, [section 6.3 on page 49](#)
  - Conductivity Probe, [section 7.3 on page 65](#)
9. Set the method.
  - pH Probe, [section 6.4 on page 51](#)
  - Conductivity Probe, [section 7.4 on page 66](#)
  - LDO Probe, [section 8.3 on page 81](#)
10. Modify Meter Options. Refer to [Section 9 on page 91](#).

## 4.2 Meter User Interface and Navigation

### 4.2.1 Keypad Description

Figure 7 shows the meter keypad and key descriptions common to all models.

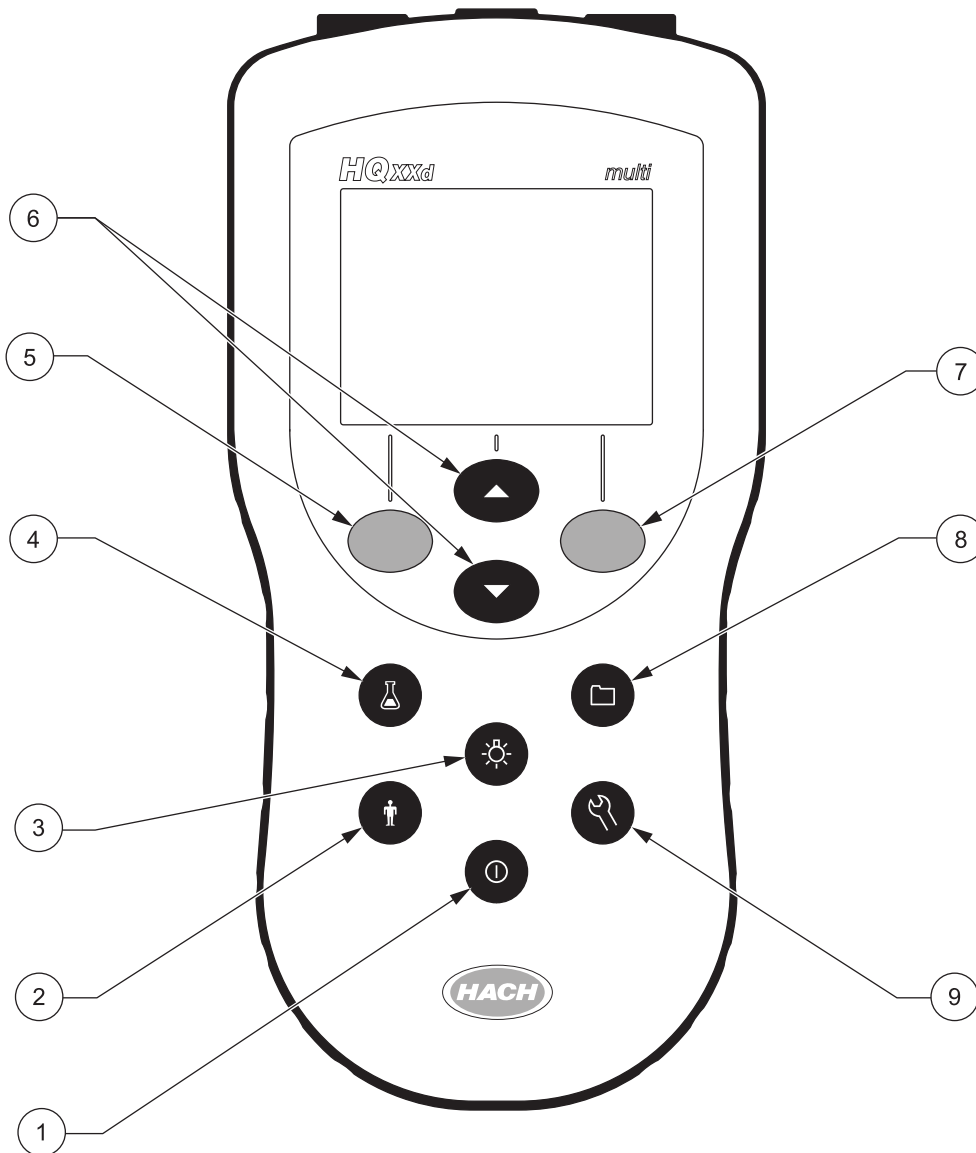


Figure 7 HQ Series Keypad Description

1	<b>POWER ON/OFF</b>	6	<b>UP and DOWN Softkeys:</b> function changes with software menus
2	<b>OPERATOR ID</b>	7	<b>GREEN/RIGHT Softkey:</b> function changes with software menu
3	<b>BACKLIGHT</b>	8	<b>DATA LOG</b>
4	<b>SAMPLE ID</b>	9	<b>METER OPTIONS AND PARAMETER METHODS</b>
5	<b>BLUE/LEFT Softkey:</b> function changes with software menu		



## 4.2.2 Display Description (Single and Dual)

### 4.2.2.1 Using Single Screen Mode

The meter displays the concentration, units, temperature, calibration status, operator ID, sample ID, date, and time as shown in [Figure 8](#).

The HQ40d meter can display two parameters simultaneously in the dual screen mode. See [section 4.2.2.2](#).

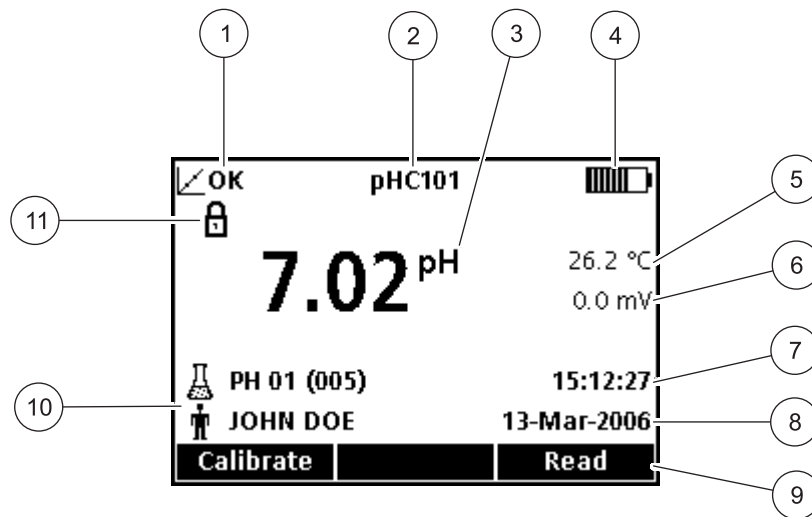
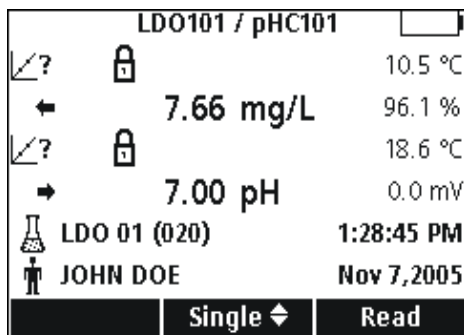


Figure 8 Single Screen Mode

1	Calibration Indicator	7	Time
2	IntelliCAL™ Probe Type	8	Date
3	Main Measurement Unit	9	Menu Driven Function Bar (Operated by <b>GREEN/RIGHT</b> key, <b>UP</b> and <b>DOWN</b> keys, and <b>BLUE/LEFT</b> key)
4	Battery Status	10	Sample and Operator Identification
5	Sample Temperature	11	Stability or Display Lock Indicator
6	Additional Units		

### 4.2.2.2 Using Dual Screen Mode (HQ40d only)

When two probes are connected to the HQ40d meter, the screen can show the reading from both probes simultaneously, or show just one probe.



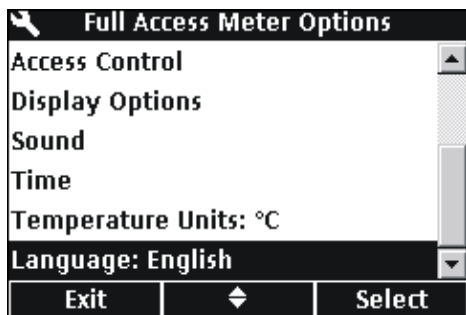
With two probes connected to the meter, use the **UP** and **DOWN** keys to change the screen mode to single or dual screen. In dual screen mode, the **UP** key will select the left probe for single view and the **DOWN** key will select the right probe.

### 4.3 Selecting the Language

The meter can be operated in several different languages. When the meter is turned on for the first time, the user must select a language before any other meter functions can be accessed.

To select or change the language:

1. Press the **METER OPTIONS** key.
2. Use the **UP** and **DOWN** keys to highlight **Language**. Press the **GREEN/RIGHT** key under **Select**.
3. Use the **UP** and **DOWN** keys to select a language. Press the **GREEN/RIGHT** key under **OK**.



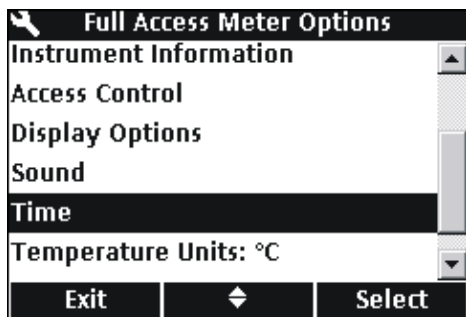
### 4.4 Setting the Date and Time

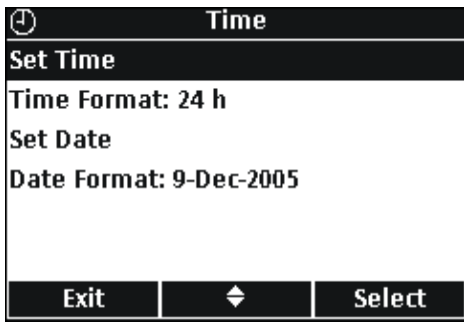
#### **CAUTION**

**BEFORE ATTACHING THE PROBE FOR THE FIRST TIME: Set the date and time in the meter before attaching the IntelliCAL probe for its first use. If the meter date and time are incorrect when the probe is installed, the probe will retain this incorrect time stamp for the remainder of its service life.**

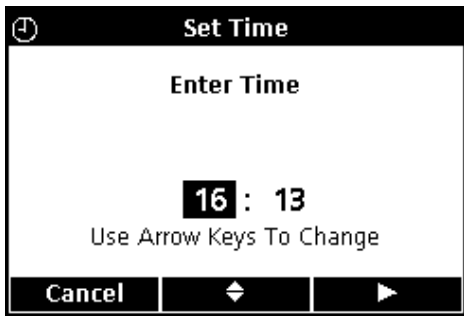
To change the time and date that is displayed on the meter:

1. Press the **METER OPTIONS** key.
2. Use the **UP** and **DOWN** keys to highlight **Time**. Press the **GREEN/RIGHT** key under **Select**.





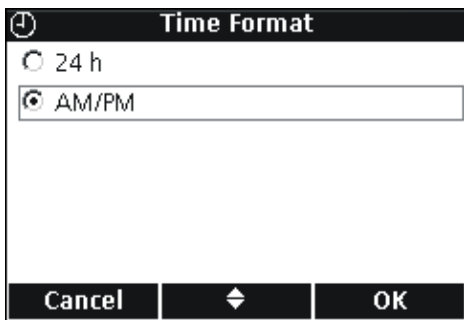
- By default, time entries use the 24-hour clock format. Use the **UP** and **DOWN** keys to highlight **Set Time**, **Time Format**, **Set Date**, or **Date Format**. Press the **GREEN/RIGHT** key under **Select**.



**SET TIME**

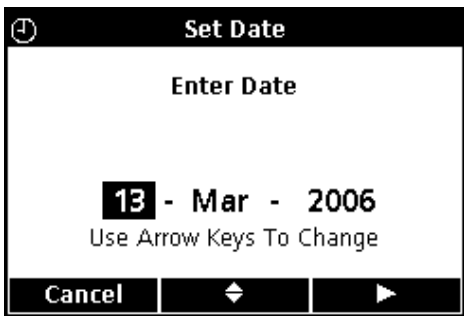
Use the **UP** and **DOWN** keys to change the time. Press the **GREEN/RIGHT** key to advance to the next space.

Press the **GREEN/RIGHT** key until OK replaces the right arrow in the function bar. Select OK to complete the entry. All time entry is in 24-hour format.



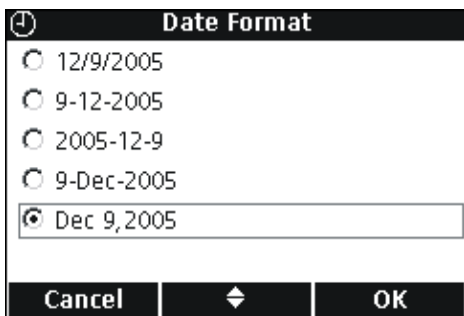
**TIME FORMAT**

Use the **UP** and **DOWN** keys to select an AM/PM (12-hour) or 24-hour time clock. Press the **GREEN/RIGHT** key under OK.



**SET DATE**

By default, date entries use the day-month-year format. Use the **UP** and **DOWN** keys to change the date. Press the **GREEN/RIGHT** key to advance to the next space. Press the **GREEN/RIGHT** key until OK replaces the right arrow in the function bar. Select OK to complete the entry.



**DATE FORMAT**

Use the **UP** and **DOWN** keys to select a date format. Press the **GREEN/RIGHT** key under OK.



## Section 5 Standard Operation

**Important Note:** Screen shot examples in this manual are included for illustrative purposes, and may not reflect actual results.

### 5.1 Setting the Sample and Operator Identification



Use the **SAMPLE ID** key to associate sample readings with a particular sample location. The Sample ID will be shown in the lower left corner of the display, and all stored data will include this ID. If no Sample ID is entered, the meter will display a generic "Sample ID".

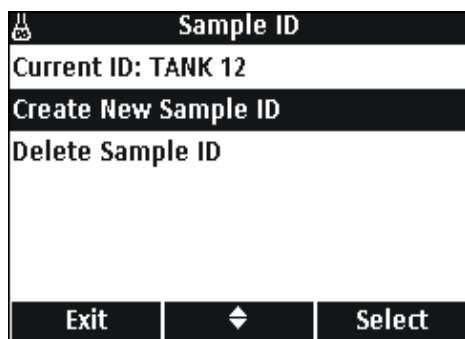


Use the **OPERATOR ID** key to associate sample readings with an individual. The Operator ID will be shown in the lower left corner of the display, and all stored data will include this ID. If no Operator ID is entered, the meter will display three dashes in the display.

#### 5.1.1 Sample ID

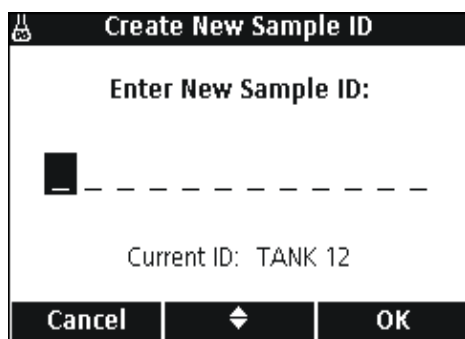
**Note:** Sample and Operator ID text can be entered using the optional keyboard.

##### 5.1.1.1 Creating a New Sample ID



To enter a new Sample ID:

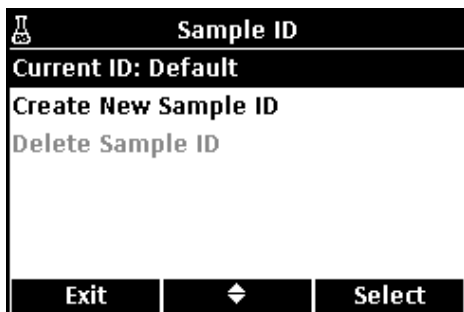
1. Press the **SAMPLE ID** key.
2. Use the **UP** and **DOWN** keys to highlight **Create New Sample ID**. Press the **GREEN/RIGHT** key under Select.



3. Use the **UP** and **DOWN** keys to scroll through the letters and numbers. To accept a letter or number, press the **GREEN/RIGHT** key. The cursor will advance to the next space.
4. Repeat the previous step to add additional letters or numbers until the name is complete. To add a space, scroll to the blank space between A and 9 using the **UP** and **DOWN** keys and press the **GREEN/RIGHT** key. To replace a letter or number, press the **BLUE/LEFT** key and re-enter the letter or number.
5. Press the **GREEN/RIGHT** key until OK replaces the right arrow in the function bar. Select OK to complete the entry.

## Standard Operation

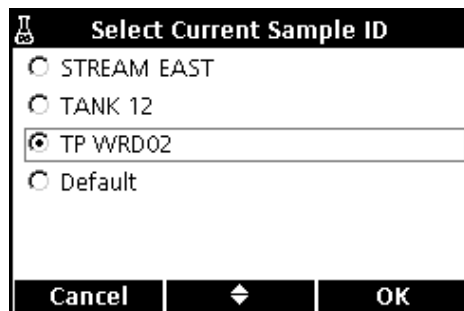
### 5.1.1.2 Selecting a Sample ID



The screen displays the 'Sample ID' menu. At the top, it shows 'Current ID: Default'. Below this are two options: 'Create New Sample ID' and 'Delete Sample ID'. At the bottom, there are three buttons: 'Exit', a directional pad (up, down, left, right arrows), and 'Select'.

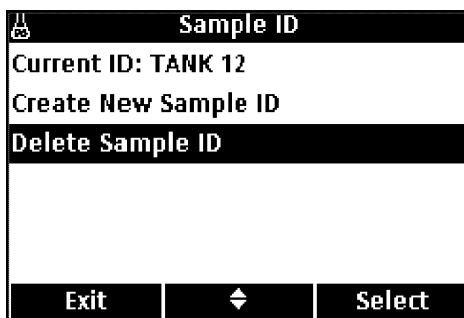
To select a different Sample ID:

1. Press the **SAMPLE ID** key.
2. Use the **UP** and **DOWN** keys to highlight **Current ID**. Press the **GREEN/RIGHT** key under Select.
3. Use the **UP** and **DOWN** keys to select the correct Sample ID. Press the **GREEN/RIGHT** key under OK.



The screen displays the 'Select Current Sample ID' menu. It lists four options with radio buttons: 'STREAM EAST', 'TANK 12', 'TP WRD02' (which is selected), and 'Default'. At the bottom, there are three buttons: 'Cancel', a directional pad, and 'OK'.

### 5.1.1.3 Deleting a Sample ID

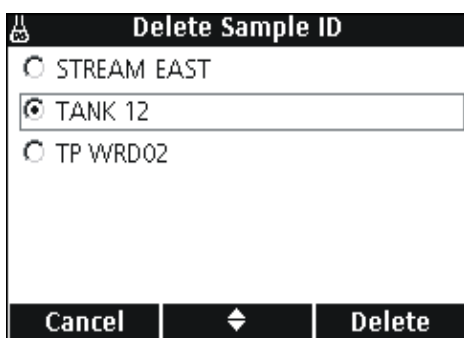


The screen displays the 'Sample ID' menu. At the top, it shows 'Current ID: TANK 12'. Below this are two options: 'Create New Sample ID' and 'Delete Sample ID'. At the bottom, there are three buttons: 'Exit', a directional pad, and 'Select'.

To delete an existing Sample ID:

1. Press the **SAMPLE ID** key.
2. Use the **UP** and **DOWN** keys to highlight **Delete Sample ID**. Press the **GREEN/RIGHT** key under Select.

*Note: The default Sample ID cannot be deleted.*

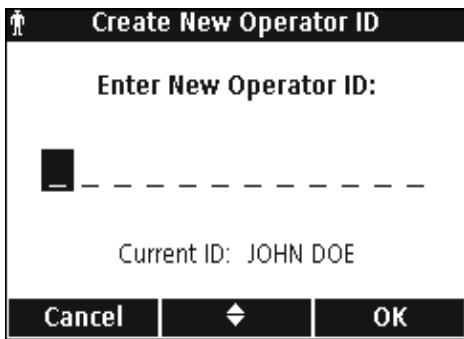
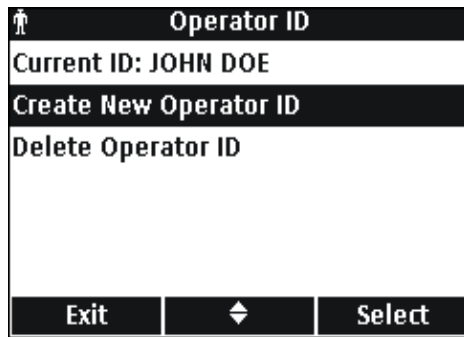


The screen displays the 'Delete Sample ID' menu. It lists three options with radio buttons: 'STREAM EAST', 'TANK 12' (which is selected), and 'TP WRD02'. At the bottom, there are three buttons: 'Cancel', a directional pad, and 'Delete'.

3. Use the **UP** and **DOWN** keys to select the Sample ID to be deleted. Press the **GREEN/RIGHT** key under Delete.

## 5.1.2 Operator ID

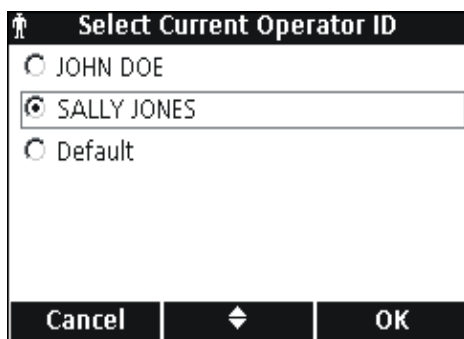
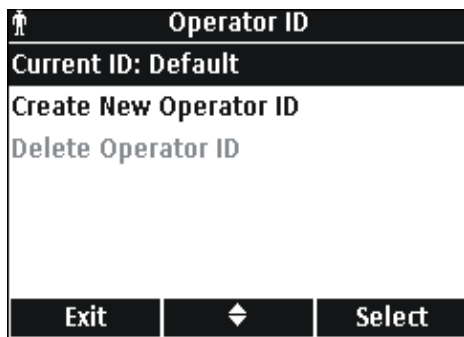
### 5.1.2.1 Creating a New Operator ID



To create a new Operator ID:

1. Press the **OPERATOR ID** key.
2. Use the **UP** and **DOWN** keys to highlight **Create New Operator ID**. Press the **GREEN/RIGHT** key under Select.
3. Use the **UP** and **DOWN** keys to scroll through the letters and numbers. To accept a letter or number, press the **GREEN/RIGHT** key. The cursor will advance to the next space.
4. Repeat the previous step to add additional letters or numbers until the name is complete. To add a space, scroll to the blank space between A and 9 using the **UP** and **DOWN** keys and press the **GREEN/RIGHT** key. To replace a letter or number, press the **BLUE/LEFT** key and re-enter the letter or number.
5. Press the **GREEN/RIGHT** key until OK replaces the right arrow in the function bar. Press the **GREEN/RIGHT** key under OK.

### 5.1.2.2 Selecting an Operator ID

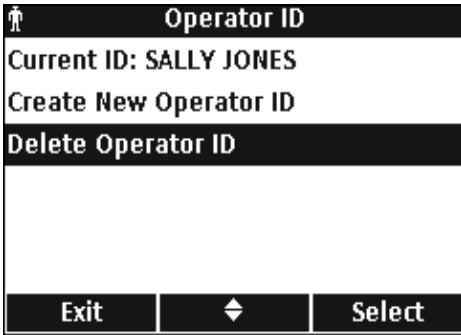


To select an existing Operator ID:

1. Press the **OPERATOR ID** key.
2. Use the **UP** and **DOWN** keys to highlight **Current ID**. Press the **GREEN/RIGHT** key under Select.
3. Use the **UP** and **DOWN** keys to select the Operator ID. Press the **GREEN/RIGHT** key under OK.

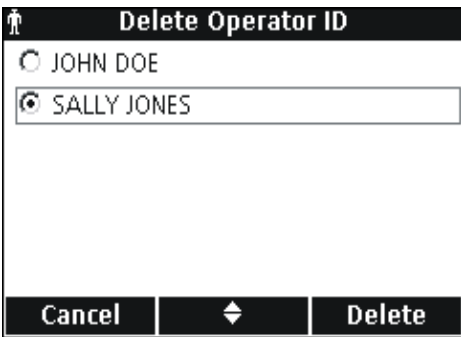
## Standard Operation

### 5.1.2.3 Deleting an Operator ID



To delete an existing Operator ID:

1. Press the **OPERATOR ID** key.  
*Note: The Default Operator ID cannot be deleted*
2. Use the **UP** and **DOWN** keys to highlight **Delete Operator ID**. Press the **GREEN/RIGHT** key under Select.



3. Use the **UP** and **DOWN** keys to select the Operator ID to be deleted. Press the **GREEN/RIGHT** key under Delete.  
*Note: If the Current Operator ID is deleted, Default becomes the Current Operator ID.*

## 5.2 Using the Data Log

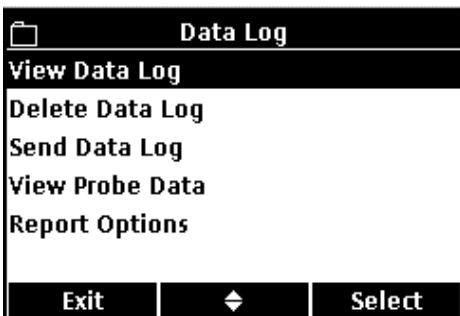
### 5.2.1 Storing Data



The HQ series portable meters can store up to 500 sample measurement, calibration, or check standard measurement results.

Data is stored automatically when Press to Read or Interval is selected for Measurement Mode in the Meter Options menu. When Continuous is selected, data will only be stored when the **GREEN/RIGHT** key under Store is pressed.

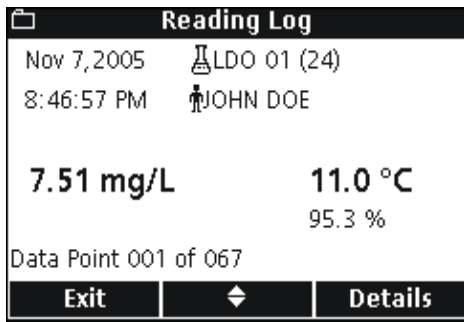
### 5.2.2 Viewing Stored Data



The data log records events chronologically, and displays the current number of data records (for example Data Record 250 of 500). The most recent data record is saved as 001 of 500. Perform the following to recall data:

1. Press the **DATA LOG** key.
2. Use the **UP** and **DOWN** keys to highlight **View Data Log**. Press the **GREEN/RIGHT** key under Select.
3. The display shows the most recent measurement, calibration, or check standard. Use the **UP** and **DOWN** keys to scroll through the stored data.



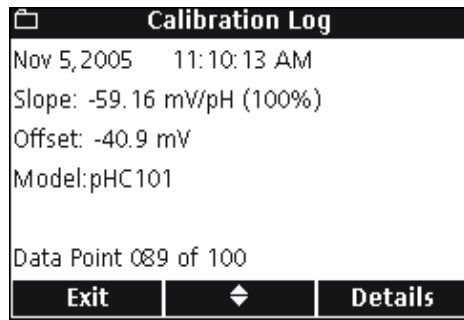


**READING LOG**

The measurement or Reading Log shows the most recent measurement value with associated time, date, operator and sample ID. A warning message appears if an error is associated with the measurement such as over limit or expired calibration.

The first screen displays information associated with the reading.

Press the **GREEN/RIGHT** key to access the calibration details for the reading. Press the **UP** and **DOWN** keys under Details. Scroll (if necessary) to the desired information associated with the reading.

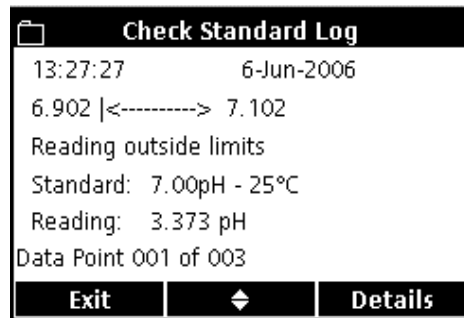


**CALIBRATION LOG**

The Calibration Log shows the most recent calibration data. Any error messages appear before other calibration data. If there are multiple error messages, they are listed in the Details screen.

The first screen displays information associated with the calibration.

Press the **GREEN/RIGHT** key to access the calibration details for the calibration. Press the **UP** and **DOWN** keys under Details. Scroll (if necessary) to the desired information associated with the reading.



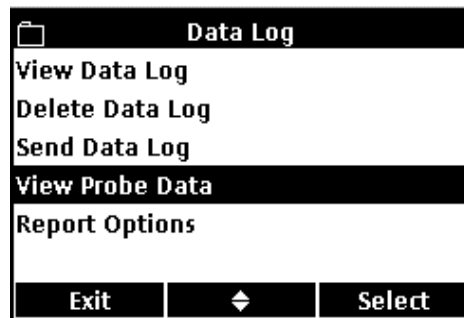
**CHECK STANDARD LOG**

The Check Standard Log (pH or conductivity only) shows the most recent check standard data with results.

The first screen displays the results of the check standard.

Press the **GREEN/RIGHT** key to access the calibration details for the reading. Press the **UP** and **DOWN** keys under Details. Scroll (if necessary) to the desired information associated with the reading.

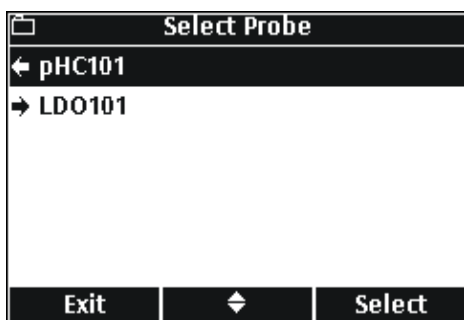
**5.2.3 Viewing Probe Data**



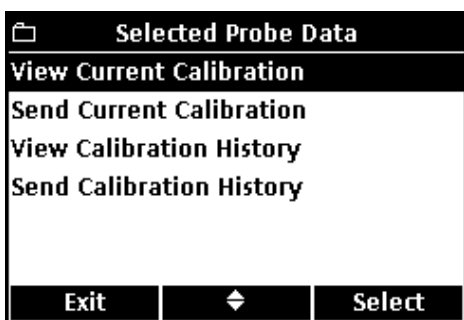
*Note: A probe must be connected to the meter to use the View Probe Data function.*

1. Press the **DATA LOG** key on the meter.
2. Use the **UP** and **DOWN** keys to highlight **View Probe Data**. Press the **GREEN/RIGHT** key under Select.

## Standard Operation



3. If only one probe is connected, proceed to Step 4. If two probes are connected (HQ40d only), the connected probes will be displayed. Use the **UP** and **DOWN** keys to highlight the probe. Press the **GREEN/RIGHT** key under Select.

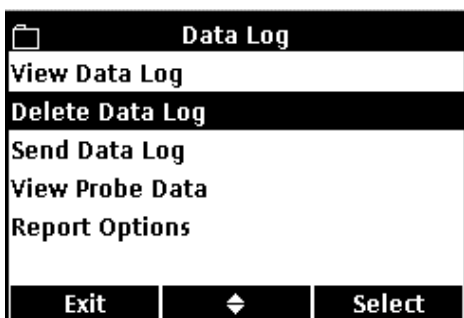


4. Use the **UP** and **DOWN** keys to highlight one of the selections for Probe Data. Press the **GREEN/RIGHT** key under Select.

### 5.2.4 Deleting Data

Data will be automatically deleted when the data log is full on a first in first out basis (oldest data deleted first).

Data can be deleted manually when Access Control is off, or when a valid password is entered.



1. Press the **DATA LOG** key.
2. Use the **UP** and **DOWN** keys to highlight **Delete Data Log**. Press the **GREEN/RIGHT** key under Select.



3. The display will show "Delete All Data?". Press the **GREEN/RIGHT** key under Select to delete all stored data.

## 5.3 Transferring Data

Data can be transferred to a printer, flash memory stick, or computer (PC) using the USB connection on the USB/DC power adapter. The meter must be powered on *after* connection to AC power for data transfer to occur.

**Note:** If the response time is slow when transferring data, reformat the flash memory stick or computer to use the file allocation table (FAT) format.

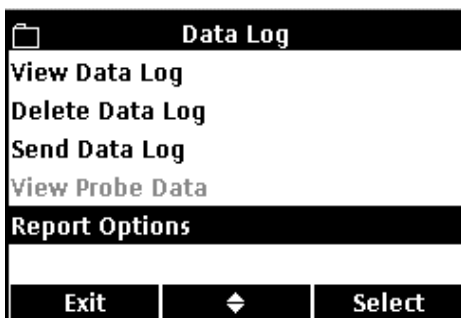
### 5.3.1 Transferring Data Options

Data that is sent to a printer can be configured to contain one, two, or three lines of information (Basic, Advanced, or Total Reports). Data that is transferred to a computer or flash memory stick can be configured to include or omit a column header row.

#### 5.3.1.1 Selecting Printed Report Types

The data log can be printed at three levels of detail: Basic Report, Advanced Report or Total Report as described in [section 5.4.2 on page 36](#).

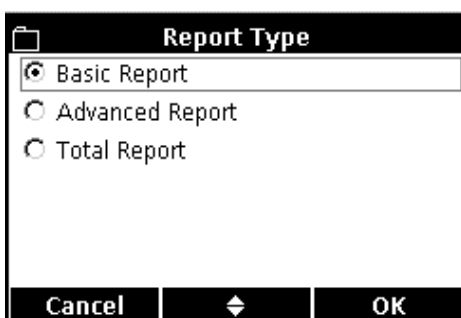
**Note:** The Report Type applies only to reports that are sent to a printer. Data that is transferred to the USB Flash memory Stick or PC will always receive the Total Report.



1. Press the **DATA LOG** key. Use the **UP** and **DOWN** keys to highlight **Report Options**. Press the **GREEN/RIGHT** key under Select.



2. Use the **UP** and **DOWN** keys to highlight **Report Type**. Press the **GREEN/RIGHT** key under Select.



3. Use the **UP** and **DOWN** keys to select Basic Report, Advanced Report, or Total Report. Press the **GREEN/RIGHT** key under OK.

Printed reports will contain the level of detail that is selected.

### 5.3.1.2 Including Column Headers in Data Files

The HQd meters include a row of column headings whenever data is stored in the meter. This header contains descriptions of the data so that the downloaded data is easily recognizable ([section 5.6 on page 42](#)). The header information is sent to a USB flash memory stick and/or PC when the column headers option is on.

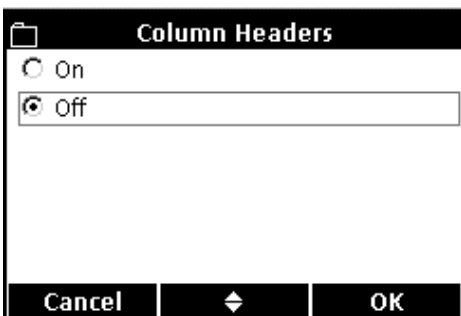
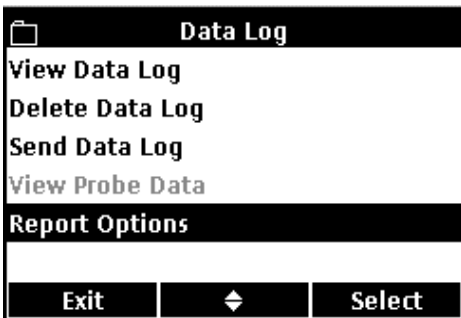
**Note:** *Column Headers applies only to data that is sent to a USB Flash memory Stick or PC.*

The column headers option is on by default and should be left on for most users. If an application or post-processing method is used that is incompatible with the headers, the column headers can be turned off.

**Note:** *If the column headers option is changed from off to on, or if the language setting is changed, a column header row will appear in the data table at the point where the change took place.*

To turn column headers off or on:

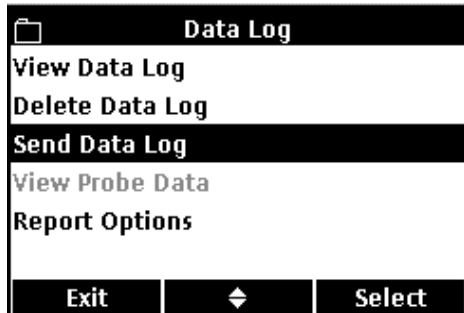
1. Press the **DATA LOG** key. Use the **UP** and **DOWN** keys to highlight **Report Options**. Press the **GREEN/RIGHT** key under **Select**.
2. Use the **UP** and **DOWN** keys to highlight **Column Headers**. Press the **GREEN/RIGHT** key under **Select**.
3. Use the **UP** and **DOWN** keys to select **On** or **Off**. Press the **GREEN/RIGHT** key under **OK**.



### 5.3.2 Sending Data to a Printer



USB - Peripheral



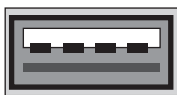
The HQd meters can connect to a compatible 72-column printer using a USB cable. Printed report formats are detailed in [section 5.4 on page 36](#).

To send data to a printer:

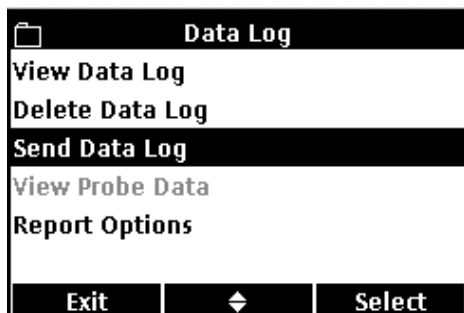
1. Turn off the meter. Connect the meter to an electrical outlet using the USB/DC power adapter and then turn on the meter.
2. Connect the printer cable to the peripheral USB connector on the USB/DC power adapter (for more information see [section 3.5 on page 16](#)).
3. Press the **DATA LOG** key on the meter.
4. Use the **UP** and **DOWN** keys to highlight **Send Data Log**. Press the **GREEN/RIGHT** key under Select.
5. The display will show "Sending Data" to indicate that the data is being sent to the printer. All measurement data, calibration data, and check standard results will be printed at the level of detail selected ([section 5.3.1.1 on page 31](#)).

**Important Note:** Never disconnect USB devices from the USB/DC power adapter or the USB/DC power adapter from the meter when the "Sending Data" screen is displayed, or the meter may lock up.

### 5.3.3 Sending Data to a Flash Memory Stick



USB - Peripheral



To send data to a flash memory stick:

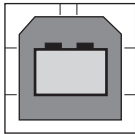
1. Turn off the meter. Connect the meter to an electrical outlet using the USB/DC power adapter and then turn on the meter.
2. Connect the flash memory stick to the peripheral USB connector on the USB/DC power adapter (for more information see [section 3.5 on page 16](#)).
3. Press the **DATA LOG** key on the meter.
4. Use the **UP** and **DOWN** keys to highlight **Send Data Log**. Press the **GREEN/RIGHT** key under Select.

## Standard Operation



5. The display will show "Sending Data" to indicate that the data is being stored on the flash memory stick. All measurement data, calibration data, and check standard results will be stored on the memory stick in a text (.txt) file format.

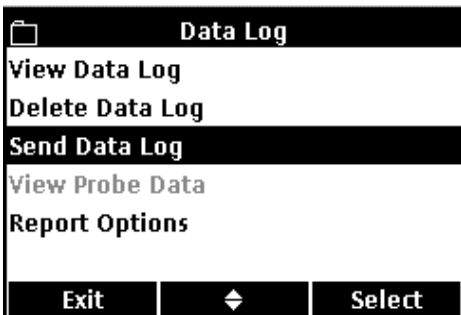
### 5.3.4 Sending Data to a Computer using the HQd PC Application Software



USB - Host

To send data directly to a computer:

1. Load the PC Application Software onto a PC.
2. Turn off the meter. Connect the meter to an electrical outlet using the USB/DC power adapter and then turn on the meter.
3. Connect a USB cable (Cat. No. 59240-00) to the host USB connector on the USB/DC power adapter and to the computer.
4. Open the PC Application software on the PC. Click on the green triangle shown in the menu bar to initiate a connection.
5. Press the **DATA LOG** key on the meter.
6. Use the **UP** and **DOWN** keys to highlight **Send Data Log**. Press the **GREEN/RIGHT** key under Select.

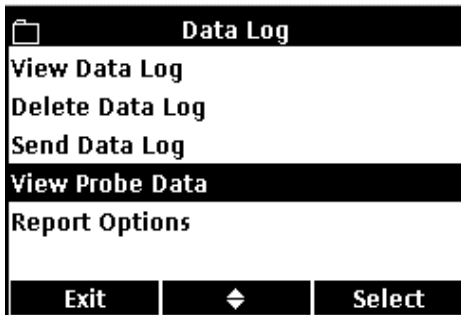


7. The meter will show "Sending Data". The data will appear in the PC Application Software window. The file is saved in Comma Separated Values (.csv) file format.

**Note:** The PC will receive the complete record. It is unaffected by whatever "Report Type" setting (Basic, Advanced, Total) is selected for printed reports.

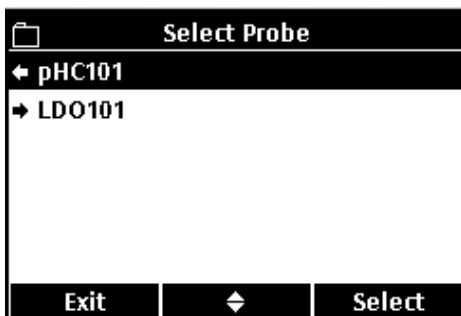
### 5.3.5 Sending Probe Calibration Data

Calibration data is included as part of the data log, but can also be specifically printed or downloaded from the stored information in the IntelliCAL probe. Printed calibration reports are detailed in [section 5.5 on page 40](#).

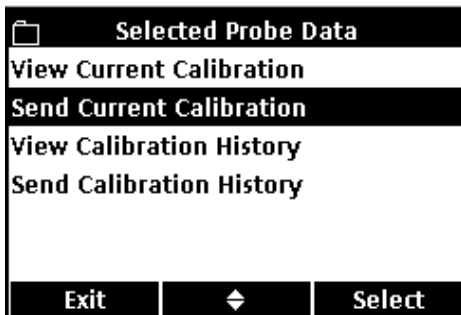


1. Press the **DATA LOG** key on the meter.
2. Use the **UP** and **DOWN** keys to highlight **View Probe Data**. Press the **GREEN/RIGHT** key under Select.

**Note:** A probe must be connected to the meter in order to use the View Probe Data function.

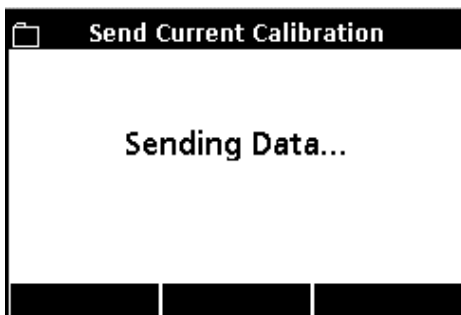


3. If only one probe is connected, proceed to Step 4. If two probes are connected (HQ40d meter only), both probes will be displayed. Use the **UP** and **DOWN** keys to highlight the desired probe. Press the **GREEN/RIGHT** key under Select.



4. Use the **UP** and **DOWN** keys to highlight **Send Current Calibration** or **Send Calibration History**.
  - **Send Current Calibration:** sends the most recent calibration information.
  - **Send Calibration History:** sends all calibration information that is stored in the probe.

Press the **GREEN/RIGHT** key under Select.



5. The display will show "Sending Data" to indicate that the data is being sent to a printer, USB flash memory stick or PC.

**Important Note:** Never disconnect USB devices from the USB/DC power adapter or the USB/DC power adapter from the meter when the "Sending Data" screen is displayed, or the meter may lock up.

## 5.4 Viewing Printed Data Log Reports

When the data log is sent to a printer (section 5.3.2 on page 33), the printed report contains all stored sample data, check standard data, and calibration information.

**Note:** All error messages will print at the end of each report option selected (Basic Report, Advanced Report, or Total Report).

### 5.4.1 Report Names

The first line of each report displays the report name, which is associated with the data log file. Figure 9 shows an example of the report name on a printed report.

9999RV123456-SENDDATA-0512131618.TXT  
RD LDO 16:14:32 13-12-05 6.59 mg/L NORTH TANK -05 JOSEPH L

Figure 9 Report Name

1	Serial Number	3	Date and Time (24 h) (YYMMDDhhmm)
2	Report Label	4	File Type Extension

### 5.4.2 Sample Results

The amount of information that is printed for sample readings varies with the selected Report Type (Basic, Advanced, or Total).

#### 5.4.2.1 Basic Reports

A Basic Report contains a single line of information per sample reading. Figure 10 details the information available in this type of report.

9999RV123456-SENDDATA-0512131618.TXT  
RD LDO 16:14:32 13-12-05 6.59 mg/L NORTH TANK -05 JOSEPH L

Figure 10 Sample Data on a Basic Report

1	Measurement Type (RD = Reading)	6	Reading Units
2	Parameter Type (pH, LDO, CD, etc.)	7	Sample ID: user-defined, displays "SAMPLE ID" if undefined
3	Time (hh:mm:ss in 24 h format)	8	Sample ID Counter
4	Date (DD-MM-YY or user-defined format)	9	Operator ID: user-defined, displays "- - -" if undefined
5	Reading Value		



### 5.4.2.2 Advanced Reports

An Advanced Report contains two lines of information per sample reading. The first line of information is the same as the information in a Basic Report. The second line includes additional information as shown in Figure 11.

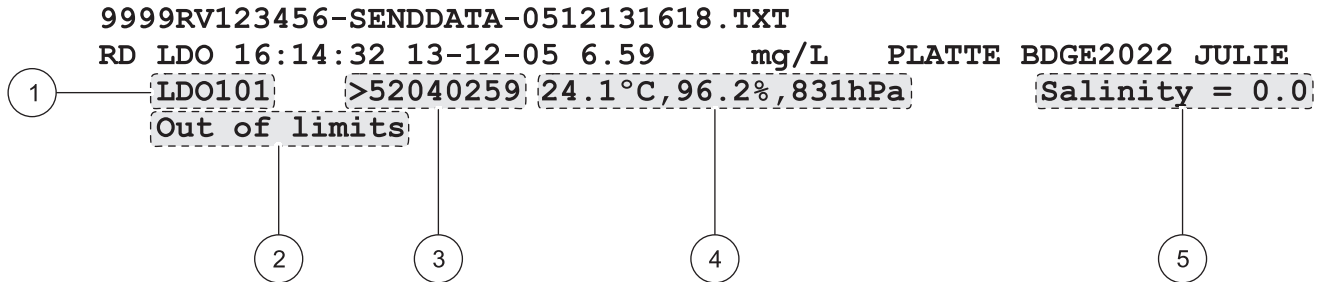


Figure 11 Sample Data on an Advanced Report

1	Probe Model Name
2	Error Message (if applicable)
3	Probe Serial Number: when using the HQ40d meter, the serial number will be prefaced by "<" or ">" to indicate which channel the probe was connected to during a dual reading.
4	Additional Units: displays all additional units associated with the reading. Contents vary depending on type of parameter being read.
5	Method Settings: displays highest-priority method setting associated with the reading. Contents vary depending on type of parameter being read and configuration of specific method.

### 5.4.2.3 Total Reports

A Total Report contains three lines of information per sample reading. The first two lines of information are the same as the information in an advanced report. The third line includes additional information as shown in Figure 12.

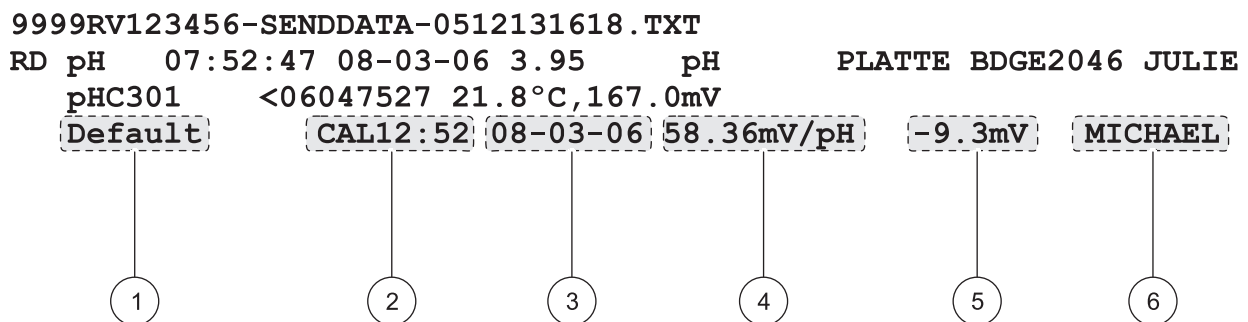


Figure 12 Sample Data on a Total Report

1	Method Name: user-defined Method Name used to take this reading
2	Calibration Time: time of last calibration, prefaced by "CAL" and displayed as hh:mm in 24 h format
3	Calibration Date: date of last calibration (DD-MM-YY or user-defined format)
4	Calibration Slope
5	Offset: contents vary depending on type of parameter being read and configuration of specific method. May be blank.
6	Calibration Operator ID: user-defined Operator ID of person who performed the last calibration. Displays "- - -" if undefined.

## Standard Operation

### 5.4.3 Calibration Results

Calibration data is included in the data log printout as two lines of information (Figure 13). The amount of information that is displayed for calibration data does not vary with the selected Report Option.

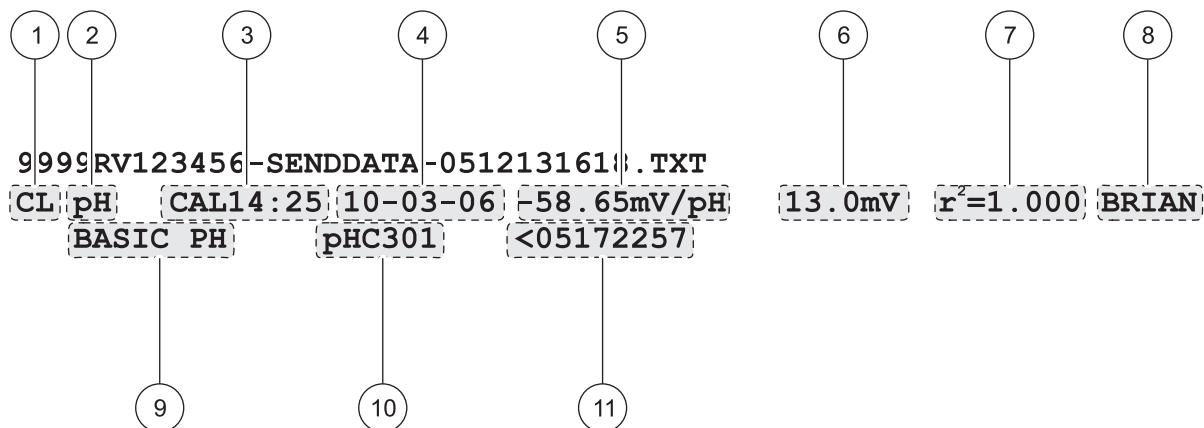


Figure 13 Calibration Data Report

1	Measurement Type (CL = Calibration)
2	Parameter Type (pH, LDO, CD, etc.)
3	Calibration Time: prefaced by "CAL" and displayed as hh:mm in 24 h format
4	Calibration Date (DD-MM-YY or user-defined format)
5	Calibration Slope
6	Offset: contents vary depending on type of parameter being read and configuration of specific method. May be blank.
7	r <sup>2</sup> : contents vary depending on type of parameter being read, configuration of specific method and number of calibration standards read. May be blank.
8	Calibration Operator ID: user-defined Operator ID of person who performed this calibration. Displays "- - -" if undefined.
9	Method Name: user-defined Method Name used to take this reading
10	Probe Model Name
11	Probe Serial Number: when using the HQ40d meter, the serial number will be prefaced by "<" or ">" to indicate which channel the probe was connected to during a dual reading

### 5.4.4 Check Standard Results

Check standard results are included in the data log printout as a single line of information (Figure 14). The amount of information that is displayed for check standard results does not vary with the selected Report Option.

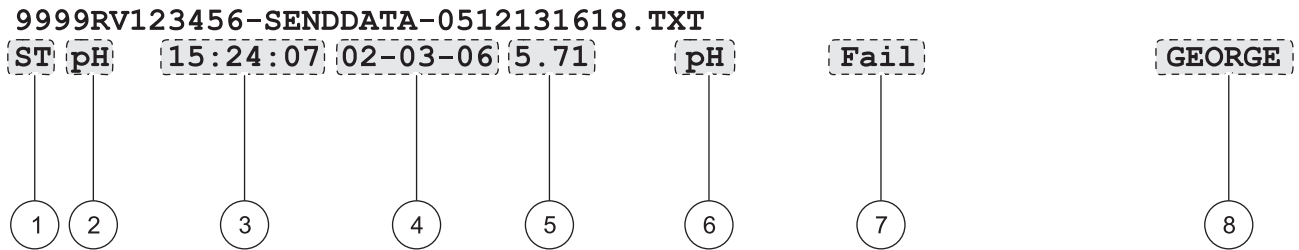


Figure 14 Check Standard Report

1	Measurement Type (ST = Check Standard)
2	Parameter Type (pH, LDO, CD, etc.)
3	Check Standard Time (hh:mm:ss in 24 h format)
4	Check Standard Date (DD-MM-YY or user-defined format)
5	Reading Value
6	Reading Units
7	Check Standard Pass/Fail: identifies whether Check Standard acceptance criteria has been met
8	Check Standard Operator ID: user-defined Operator ID of person who performed the check standard. Displays "- -" if undefined.

## 5.5 Viewing Printed Calibration Reports

A report can be printed for current calibration information or calibration history as described in [section 5.3.5 on page 35](#).

### 5.5.1 Current Calibration Reports

A Current Calibration Report contains two lines of information. [Figure 15](#) details the information available in this type of report.

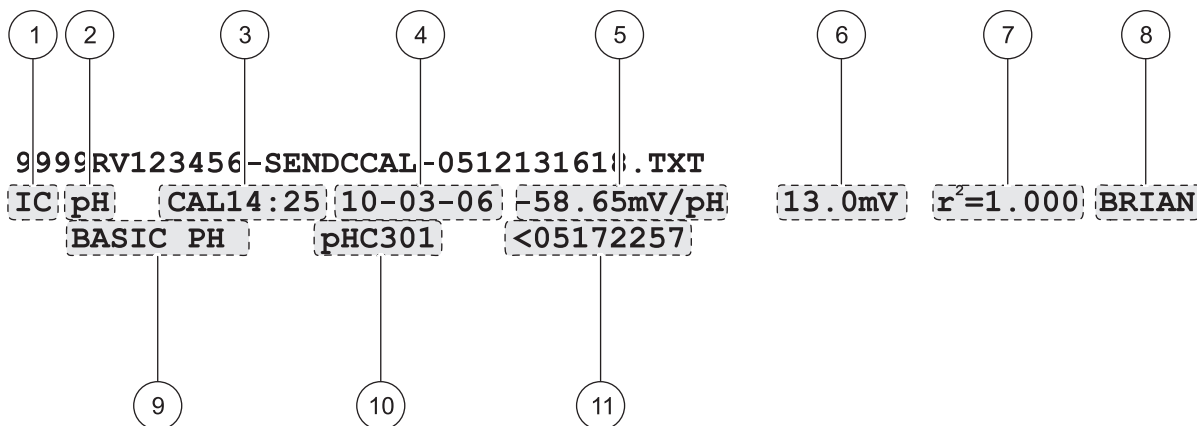


Figure 15 Current Calibration Report

1	Report Type (IC = Current Calibration)
2	Parameter Type (pH, LDO, CD, etc.)
3	Calibration Time: prefaced by "CAL" and displayed as hh:mm in 24 h format
4	Calibration Date (DD-MM-YY or user-defined format)
5	Calibration Slope
6	Offset: contents vary depending on type of parameter being read and configuration of specific method. May be blank.
7	r²: contents vary depending on type of parameter being read, configuration of specific method and number of calibration standards read. May be blank.
8	Calibration Operator ID: user-defined Operator ID of person who performed this calibration. Displays "-" if undefined.
9	Method Name: user-defined Method Name used to take this reading
10	Probe Model Name
11	Probe Serial Number: when using the HQ40d meter, the serial number will be prefaced by "<" or ">" to indicate which channel the probe was connected to during a dual reading.

### 5.5.2 Calibration History Reports

A Calibration History Report contains two lines of information per calibration. Figure 16 details the information available in this type of report.

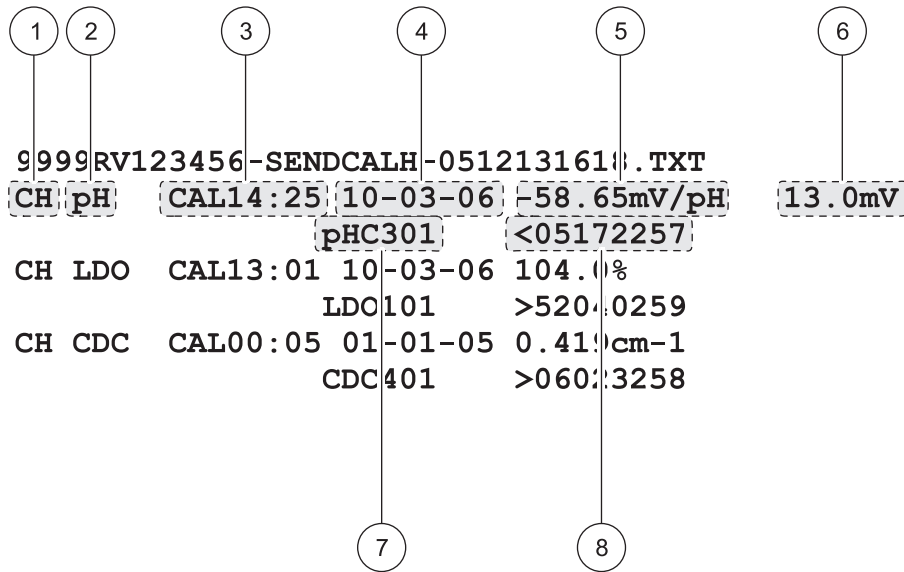


Figure 16 Calibration History Report

1	Report Type (CH = Calibration History)
2	Parameter Type (pH, LDO, CD, etc.)
3	Calibration Time: prefaced by "CAL" and displayed as hh:mm in 24 h format
4	Calibration Date (DD-MM-YY or user-defined format)
5	Calibration Slope
6	Offset: contents vary depending on type of parameter being read and configuration of specific method. May be blank.
7	Probe Model Name
8	Probe Serial Number: when using the HQ40d meter, the serial number will be prefaced by "<" or ">" to indicate which channel the probe was connected to during a dual reading.

## 5.6 Viewing Downloaded Data Files

Data sent to a flash memory stick will be found as a .txt file. Data sent to a computer will be found as a .csv file. The file name will have the following format:

"Serial Number-Data File Type-DateTime"

Table 1 details several examples of file names from a flash memory stick. The DateTime information contains the date in the "YYMMDD" format and Time in the 24-hour format.

**Table 1 Example File Names for Data Sent to a Flash Memory Stick**

Data File Type	Example File Name
Send Data Log	9999NN000000-SENDDATA-0603131624.TXT
Send Current Calibration	9999NN000000-SENDCCAL-0603131624.TXT
Send Calibration History	9999NN000000-SENDCALH -0603131624.TXT
Real Time Data	RTDATA.TXT

When opened, each line of the .txt file is a data record containing several fields separated by commas. If a field is not used or is not populated for a particular record, the field will be blank and only the comma (,) will appear in the file.

To view the data in columns, open the file using an application such as Microsoft® Excel® spreadsheet software. When viewed in a spreadsheet, each column will have a header row (column headers option must be on as detailed in [section 5.3.1.2 on page 32](#)).

The column header names with data examples are detailed in [Table 2](#). The displayed data will vary depending on the type of probe and the method of measurement that is used.

**Table 2 Data File Description**

Column No.	Column Header Name	Data Description and Example Values
1	Type	Type of data: RD = Reading CL = Calibration CK = Check Standard CH = Calibration History IC = Current Calibration
2	Parameter Type	Parameter: LDO, pH, or CD (conductivity)
3	Date	Date of reading: stored in user-defined Date Format
4	Time	Time of reading: stored in user-defined Time Format
5	Operator ID	Operator ID of the person who performed the reading or calibration. Will display "- - -" if default Operator ID is used.
6	Probe Model	Model number of the probe, for example pH101, CDC401, LDO101
7	Probe SN	Probe Serial Number On the HQ40d meter, the serial number is prefaced by "<" or ">" to indicate which port the probe was connected to during the reading.
8	Method Name	User-defined name of the method used for the reading.
9	Sample ID	User-defined Sample ID for the reading Will display "Sample ID" if the default Sample ID is used.
10	Primary Reading Value	Measured value Will display "-----" if out of range.

Table 2 Data File Description

Column No.	Column Header Name	Data Description and Example Values
11	Primary Reading Units	Measurement units defined for method, for example pH or mS/cm
12	Supp Reading 1	First Supplemental Reading if applicable, for example temperature.
13	Supp Units 1	Units for First Supplemental Reading, if applicable.
14	Supp Reading 2	Second Supplemental Reading, if applicable (example: "mV" for pH)
15	Supp Units 2	Units for Second Supplemental Reading, if applicable.
16	Supp Reading 3	Third Supplemental Reading, if applicable.
17	Supp Units 3	Units for Third Supplemental Reading, if applicable.
18	Reading Setting 1	Any settings that affect the reading, for example "NaCl/Non-Linear"
19	Reading Setting 2	
20	Reading Setting 3	
21	Reading Setting 4	
22	Reading Message 1	Any message (warning, information, etc.) that was displayed during the measurement, for example "Out of limits".
23	Reading Message 2	
24	Reading Message 3	
25	Reading Message 4	
26	Check Std Value	Value of the standard that was used to verify accuracy, for example: 7.00pH–25°C (pH, temp-compensated) 7.01pH (pH, custom)
27	Check Std Units	Check standard units, for example $\mu\text{S}/\text{cm}$ . Note: pH is not displayed here as it is included in the previous column.
28	Check Std Graph	Bar-graph showing the measurement in relation to the acceptance limits Example: "6.901 <----- -----> 7.101"
29	Check Std Status	Status of the check standard reading Example: "Reading within limits", "Reading outside limits"
30	Calibration Status	OK = current calibration is valid ? = calibration has expired
31	Cal Date	Date of Calibration Reading: stored in user-defined Date Format
32	Cal Time	Time of Calibration Reading: stored in user-defined Time Format
33	Cal Operator ID	The Operator ID specified when the probe was calibrated Will display "- -" if undefined.
34	Cal Slope Name	Slope (pH or LDO) or Cell Constant (conductivity)
35	Cal Slope	The slope value for the calibration
36	Cal Slope Aux	Used by pH to give the percent of nominal slope
37	Cal Slope Units	Units of the calibration slope Example: "mV/pH" for pH
38	Cal Offset	Calibration offset value
39	Cal Offset Units	Calibration offset units Example: "mV" for pH
40	Cal r2	Unitless calibration correlation coefficient
41	Cal Number of Std's	Number of standards used during calibration, for example 5. May be blank depending on Record Type, Parameter Type and Method Settings.
42	Cal Std 1	Known value of the first calibration standard
43	Cal Std 1 Units	Units of the first calibration standard
44	Cal Std 1 Primary Value	Measured value of the first calibration standard
45	Cal Std 1 Primary Units	Associated units for the calibration measurement
46	Cal Std 1 Supp Value	Value of supplemental measurement, for example temperature

## Standard Operation

**Table 2 Data File Description**

Column No.	Column Header Name	Data Description and Example Values
47	Cal Std 2	Value and units of the second calibration standard, if used.
48	Cal Std 2 Units	
49	Cal Std 2 Primary Value	
50	Cal Std 2 Primary Units	
51	Cal Std 2 Supp Value	
52	Cal Std 3	Value and units of the third calibration standard, if used.
53	Cal Std 3 Units	
54	Cal Std 3 Primary Value	
55	Cal Std 3 Primary Units	
56	Cal Std 3 Supp value	Value and units of the fourth calibration standard, if used.
57	Cal Std 4	
58	Cal Std 4 Units	
59	Cal Std 4 Primary Value	
60	Cal Std 4 Primary Units	
61	Cal Std 4 Supp Value	Value and units of the fifth calibration standard, if used.
62	Cal Std 5	
63	Cal Std 5 Units	
64	Cal Std 5 Primary Value	
65	Cal Std 5 Primary Units	Value and units of the sixth calibration standard, if used.
66	Cal Std 5 Supp Value	
67	Cal Std 6	
68	Cal Std 6 Units	
69	Cal Std 6 Primary Value	
70	Cal Std 6 Primary Units	Value and units of the seventh calibration standard, if used.
71	Cal Std 6 Supp Value	
72	Cal Std 7	
73	Cal Std 7 Units	
74	Cal Std 7 Primary Value	Value and units of the seventh calibration standard, if used.
75	Cal Std 7 Primary Units	
76	Cal Std 7 Supp Value	
77	Cal Std Supp Units	Units applicable to all secondary calibration readings. Example: "°C" or "°F" for temperature
78	Cal Message 1	Any messages about the calibration.
79	Cal Message 2	
80	Cal Message 3	
81	Cal Message 4	
82	Date/Time POSIX	Date and Time of Reading stored in POSIX format <sup>1</sup> Example: 1149234913
83	Cal Date/Time POSIX	Date and Time of Calibration stored in POSIX format <sup>1</sup> Example: 1111320348

<sup>1</sup> POSIX date format expresses the date and time as the number of seconds from 1/1/1970 and is provided for advanced post-processing applications.



---

## 5.7 Archiving and Exchanging User Methods

In addition to capturing real-time data and transferring data from the data log, user-created methods can be saved to a USB flash memory stick. These methods can then be archived to a PC or transferred to another HQd meter.

Whenever a flash memory stick is connected to a meter, a 'User' folder is created on the memory stick, and all user-created methods that are stored in the meter are archived to this folder.

When a memory stick is connected to a meter, any user-created methods on the meter will be downloaded to the memory stick. The 'User' folder will be recreated each time the memory stick is connected. If the 'User' folder does not exist, a new 'User' folder will be created. The meter will not upload any methods from the memory stick if the 'User' folder does not exist or is empty.

The method names will appear in the 'User' folder with a prefix by the parameter type and an underscore (e.g., LDO\_, Cond\_, pH\_), and a file extension of .NGM. Only the METHOD NAME appears in the method library in the meter.

If a method on a meter has the same name as a method on a memory stick, the method in the meter will be overwritten. For example, if a file on the USB flash memory stick has the name "LDO\_SOUR TEST.NGM", this file will overwrite an LDO method on another meter with the same displayed method name (SOUR TEST).

When a memory stick is connected to a PC, a user can delete or change the name of any method, or delete the entire 'User' folder on the memory stick. Method names that are changed must preserve the prefix (e.g. LDO\_) and the file extension (.NGM). The METHOD NAME is limited to 12 characters. Allowable characters in the METHOD NAME are A through Z, 0 through 9, and one or more spaces.

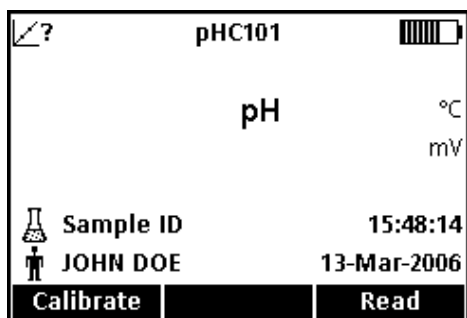


# Section 6 pH Operation and Methods

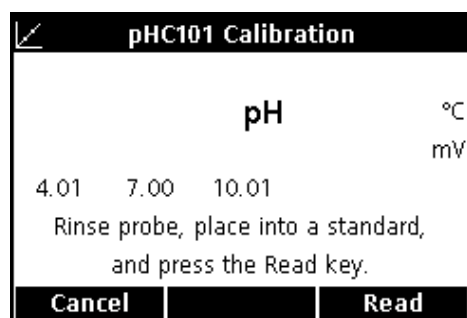
## 6.1 Calibrating the pH Probe

**Note:** Use pH buffer solutions to calibrate the pH IntelliCAL probe. The minimum number required and values of the pH buffer solutions are specified in the Calibration Options menu. A maximum of three buffers can be entered by using the "Color Coded" and DIN buffer sets. A maximum of five buffers can be entered by using the IUPAC buffer set.

**Note:** If using the HQ40d meter with two probes, the display must be in single display mode.

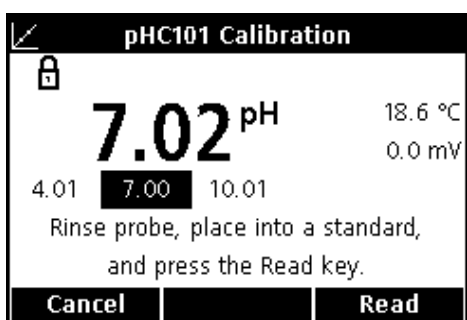


1. Press the **BLUE/LEFT** key under Calibrate.



2. The display will show the buffer values to be measured. These values are set in the Calibrations Options menu. Rinse the probe and place it in the first buffer solution. The probe automatically recognizes buffer values from a selected set, therefore entering the buffer values in a specific order is not required. However, it is recommended to begin with the lowest pH buffer for greatest accuracy.

3. Press the **GREEN/RIGHT** key under Read. The meter will automatically detect which buffer is being measured.

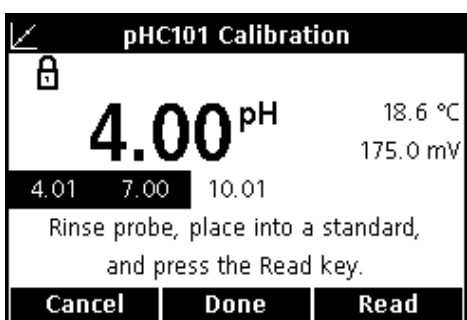


When the reading is stable, the display will highlight the buffer that has been read and display the temperature corrected pH value. Temperature correction is automatic: the displayed pH is the true pH value of the buffer at the measured temperature.

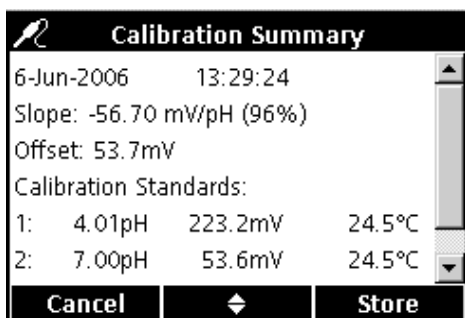
4. Rinse the probe and place it in the next buffer solution.

5. Press the **GREEN/RIGHT** key under Read.

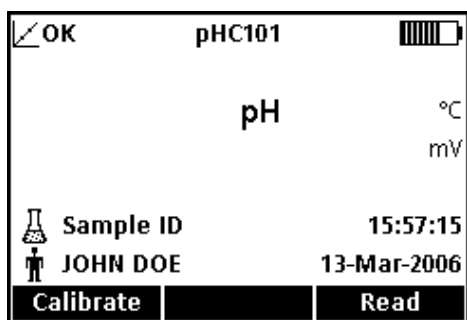
6. Repeat this procedure until the minimum number of calibration points specified in the pH Method have been acquired.



7. When the minimum number of buffer points are collected, Done appears above the **UP** key. Continue calibrating with the Method-specified calibration buffers (up to the maximum number specified in the pH Method), until all have been used, or press the **UP** key to review the Calibration Summary.



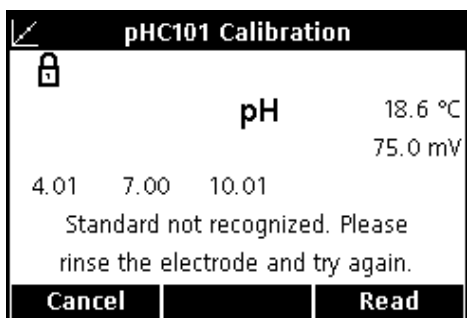
- The Calibration Summary will appear. Press the **GREEN/RIGHT** key under Store to accept the calibration and return to measurement mode. The calibration is recorded in the 500-result data log. The calibration information is also sent to a PC/printer/flash memory stick if connected.



- When the calibration is successful, the display will show OK in the upper left corner. The icon will appear as a question mark if the calibration information has expired or if a check standard has failed or been delayed.

## 6.1.1 Calibration Errors

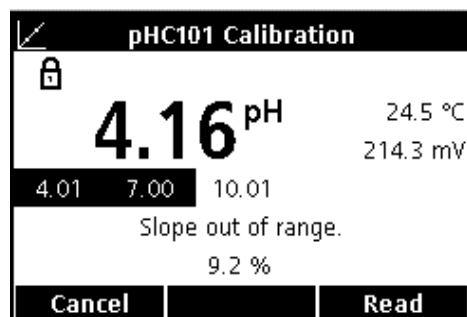
### 6.1.1.1 Standard Not Recognized



If the mV reading of the buffer does not fall within the limits set for auto detection, the display will show "Standard not recognized." If this happens, perform the following steps:

- Rinse the probe and place it in a fresh buffer solution.
- Press the **GREEN/RIGHT** key under Read. If the meter still does not recognize the buffer, be sure that the buffers used are the ones specified for the method. If so, refer to the IntelliCAL probe instruction sheet for cleaning and troubleshooting procedures.

### 6.1.1.2 Slope Error



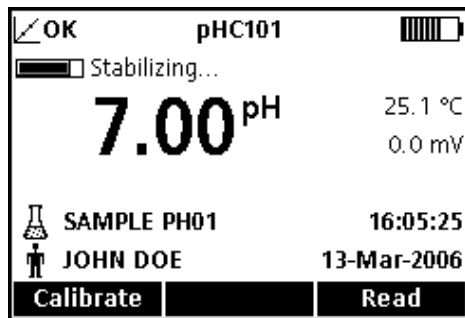
If the calibration slope does not meet the acceptance criteria, the display will show "Slope out of range". If this happens, perform the following steps:

- Obtain fresh buffer solutions. Rinse the probe and repeat the calibration.
- If the meter still gives a Slope error, be sure the buffers that are used are the ones specified for the method. If the error continues, there may be a problem with the probe.

## 6.2 Taking a pH Measurement

If complete traceability is required, set the Sample ID and Operator ID before taking a measurement.

**Note:** The default setting for Measurement Mode is “Press to Read”. If a different mode is required, change the Measurement Mode (see [section 9.5 on page 94](#)).



1. Place the pH probe into the sample.
2. Press the **GREEN/RIGHT** key under Read.
3. The display will show “Stabilizing...” and a progress bar will fill from 0 to 100% as the probe stabilizes in the sample. Stability is determined by using a fixed change in the signal/time equation. The lock icon will appear and the result will be automatically stored in the 500-result data log.
4. To take another measurement, repeat this procedure.

## 6.3 Running Check Standards

The Run Check Standards option for pH verifies reading accuracy by measuring a buffer solution of known pH value and comparing the measured to the theoretical value. The meter will indicate if the check standard passed or failed based on user-selected acceptance criteria ([section 6.5.4.4 on page 61](#)).

### 6.3.1 Automatic or Custom Check Standards

The pH value of a buffer solution will change when the temperature of the solution changes. Use one of the check standard buffers listed in the check standard options menu ([section 6.5.4.1 on page 59](#)) to best compensate for this temperature effect. When one of these buffers is selected, the solution can be at any temperature (within the temperature range), and the meter will automatically calculate the correct theoretical pH value of the standard at the measured temperature.

It is very important that the actual reading is compared to this correct theoretical value, or the check standard routine will not be valid. When a buffer is selected from the menu, the displayed pH value will include the reference temperature, for example pH 4.01 @ 25°C.

A custom check standard can be used ([section 6.5.4.2 on page 59](#)), but accuracy may be compromised. If a custom buffer is used as a check standard, no temperature compensation will be applied. The buffer must be measured at a known and constant temperature, and the pH value at that temperature must be entered into the meter. When a custom standard has been entered by the user, the displayed pH value will not include a temperature reference.

### 6.3.2 Measuring Check Standards

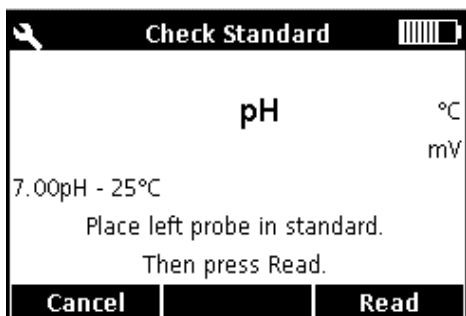
A check standard can be measured at any time by using the Meter Options menu or at specific intervals. Set the criteria for Check Standards from the Meter Options menu.

**Note:** Access Control must be off or a valid password entered before any of the check standard method options can be changed.

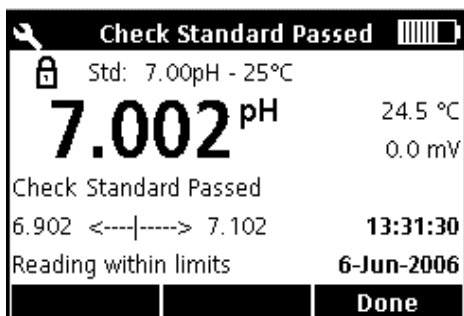
When the Check Standard reminder is ON, the meter will automatically display the Check Standard screen. The check standard can either be measured immediately, or be delayed and measured at a later time (this is a user-specified option, see Parameter Methods in [section 6.4 on page 51](#)).

To measure the Check Standard:

1. Obtain the pH buffer solution specified for the check standard. The buffer solution to be used is shown in the display.
2. Place the probe in the buffer solution.
3. Press the **GREEN/RIGHT** key under Read.

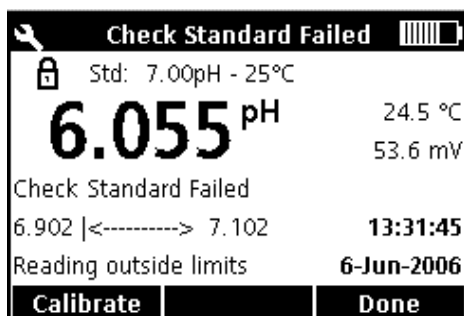


4. The display shows the value of the check standard and either "Check Standard Passed" or "Check Standard Failed" appears. If "Check Standard Passed" appears, the success criteria has been met, and the measurement has been verified to be accurate. Press the **GREEN/RIGHT** key under Done to proceed with sample measurements.

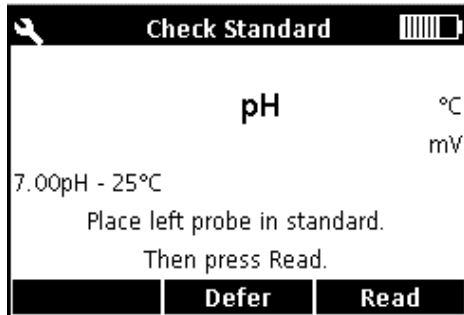


5. If "Check Standard Failed" appears, the measurement is outside of the accepted limits.

If the acceptance criteria is set to "Cal Expires on Failure: Yes", the instrument will display the **CALIBRATION ?** icon until it is re-calibrated. Press the **BLUE/LEFT** key under Calibrate and follow the steps for calibration.

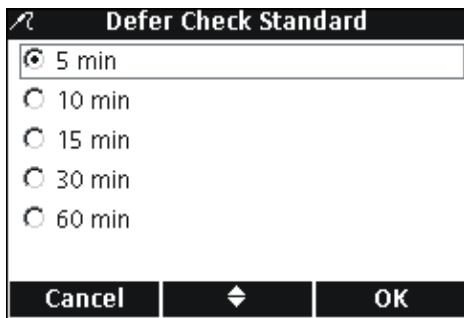


### 6.3.3 Deferring a Check Standard



A Check Standard Reminder can be deferred to a later time. This option is set in the Parameter Methods menu so that a supervisor can control this function. A password is required to change this setting. To defer the Check Standard measurement to a later time, use the Reading Check Standard screen.

1. Press the **UP** key under Defer.



2. Use the **UP** and **DOWN** keys to select when the next reminder will be displayed.

3. Press the **GREEN/RIGHT** key under OK. The Check Standard reminder will appear after the selected time has passed.

## 6.4 Setting the pH Method



The pH Method menu is available via the **METER OPTIONS/PARAMETER METHODS** key when Access Control is off, or when a valid password is entered. A pH probe must be connected to the meter to edit pH methods. Method selection is not restricted.

[Table 3](#) outlines the menu options for a pH Method. These options do not need to be changed if the default method is used. Modify Current Method submenus and default settings are described in [section 6.5 on page 52](#).

The HQ series meters contain a default method for pH with settings for measurement, calibration, check standards, and units. The default settings cannot be changed.

Use the Save Current Method As function to save the selected method with a new name. The meter settings for this new method can then be modified.

**Note:** To enter options that are different from the default settings, a new method must be created and then modified, as described in [section 6.5.1 on page 53](#).

Table 3 pH Methods Menu Summary

pH MAIN MENU	pH SUBMENU
Current Method	Set Current Method
Save Current Method As	New Method Name
Modify Current Method	Measurement Options
	Calibration Options
	Check Standards Options
	Units
Delete a Method	Delete a Method

### 6.5 Modify Current Method Menu for pH Summary

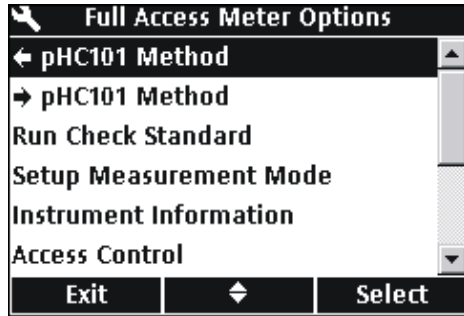
pH METHOD OPTION	AVAILABLE SELECTIONS	DEFAULT SETTING
<b>Measurement Options</b>		
Resolution	0.1 Fast 0.01 Fast 0.01 Medium 0.01 Slow 0.001 Slow	0.01 Medium
Measurement Limits	Lower Limit: 0.00–14.00 pH Upper Limit 0.00–14.00 pH	Lower: 0.00 pH Upper: 14.00 pH
<b>Calibration Options</b>		
Buffer set	Color Coded 4.01, 7.00, 10.01 IUPAC 1.68, 4.01, 7.00, 10.01, 12.45 DIN 1.09, 4.65, 9.23	Color Coded 4, 7, 10
Set Calibration Reminder	Reminder: On or Off Repeat: 2 h, 4 h, 8 h, 2 d, 5 d, 7 d Expires: Immediately, Reminder +30 min, + 1 h, + 2 h, continue reading	Reminder: Off Repeat: 8h Expires: +30 min.
Minimum Cal Points	1, 2, or 3 Calibration Points	1 Calibration Point
Slope Limit	Slope Limit: 0 to ±10%	±5%
<b>Check Standards Options</b>		
Check Standard	0–14 pH	7 pH buffer
Check Standard Reminder	Reminder: On or Off Repeat: 2 h, 4h, 8h, 12 h, 24 h Allow Defer: Yes or No	Reminder: Off Repeat: 4h Defer: Yes
Acceptance Criteria	Acceptance Limits: 0.01–1.00 pH Calibration Expires On Failure: Yes or No	±0.05 pH No
Standard Value <sup>1</sup>	Enter a Value	7.00 pH
<b>Units</b>	pH or mV	pH

<sup>1</sup> For Custom Check Standard only

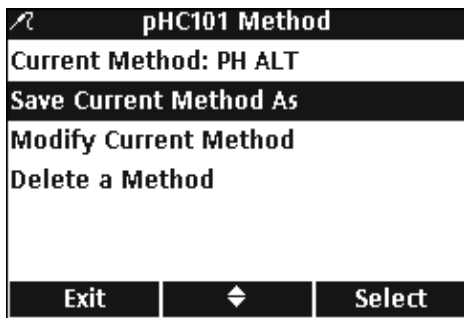


### 6.5.1 Modifying pH Methods

A new pH method can be entered when Access Control is off, or when a valid password is entered.

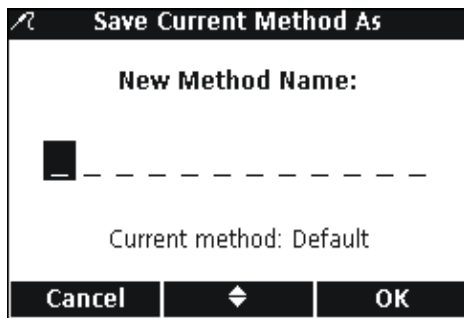


1. Press the **OPTIONS** key.
2. Use the **UP** and **DOWN** keys to highlight **pHC101 Method**. Press the **GREEN/RIGHT** key under Select.



3. Use the **UP** and **DOWN** keys to highlight **Save Current Method As**. Press the **GREEN/RIGHT** key under Select.

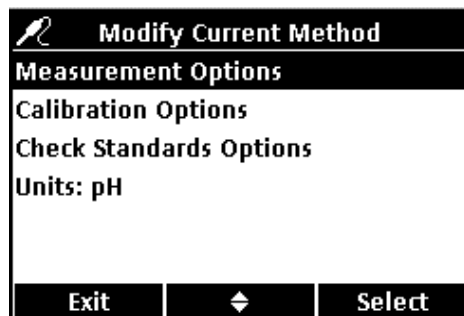
*Note: The default method cannot be modified or deleted, but can be saved with a new name (Save Current Method As) and then modified.*



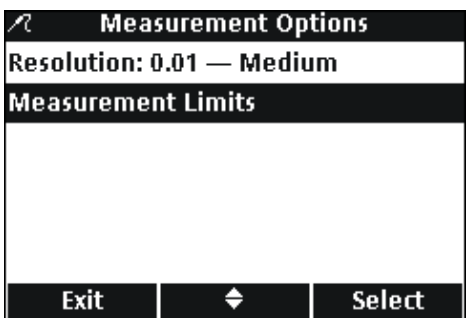
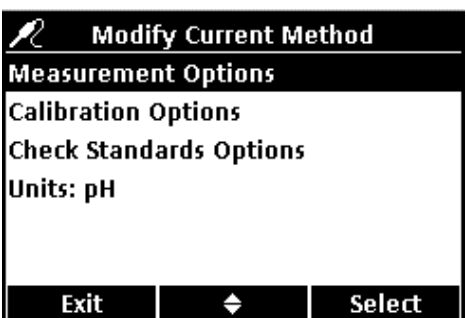
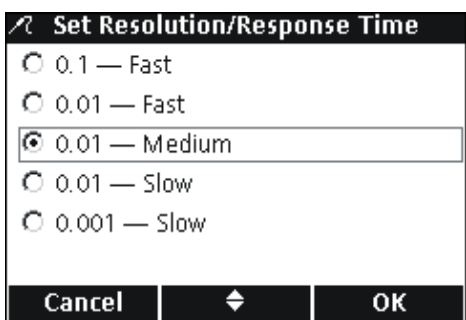
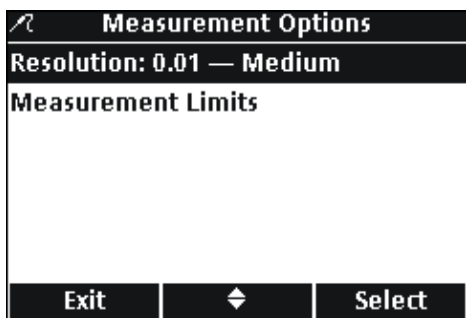
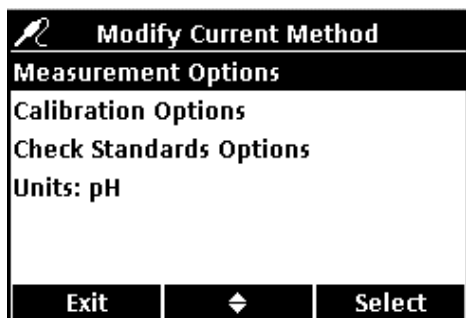
4. Use the **UP** and **DOWN** keys to scroll through the letters and numbers. To select a letter or number, press the **GREEN/RIGHT** key. The cursor will advance to the next space.
5. Repeat the previous step to add additional letters or numbers until the name is complete. To add a space, scroll to the blank space (between A and 9) using the **UP** and **DOWN** keys and press the **GREEN/RIGHT** key. To delete a letter or number, press the **BLUE/LEFT** key and re-enter the letter or number.
6. Press the **GREEN/RIGHT** key until OK replaces the Right arrow in the function bar. Press the **GREEN/RIGHT** key under OK. Alternately, use the accessory USB keyboard option.

### 6.5.2 Modifying the pH Measurement Options

Edit measurement options to change the displayed resolution or upper and lower pH limit.



1. With **Measurement Options** highlighted in the Modify Current Method menu, press the **GREEN/RIGHT** key under Select.

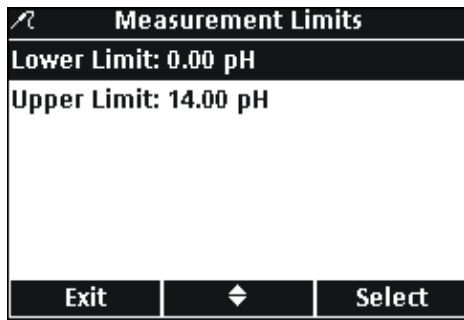


### To Edit the Resolution

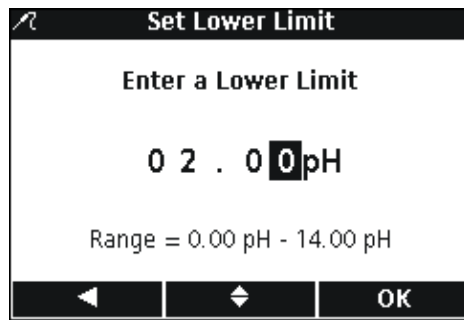
1. With **Measurement Options** highlighted in the Modify Current Method menu, press the **GREEN/RIGHT** key under Select.
2. With **Resolution** highlighted, press the **GREEN/RIGHT** key under Select.
3. Use the **UP** and **DOWN** keys to select the desired resolution and speed of response. The most accurate readings are obtained at the “slow” response settings. Press the **GREEN/RIGHT** key under OK.

### To Edit the Upper and Lower pH Limits

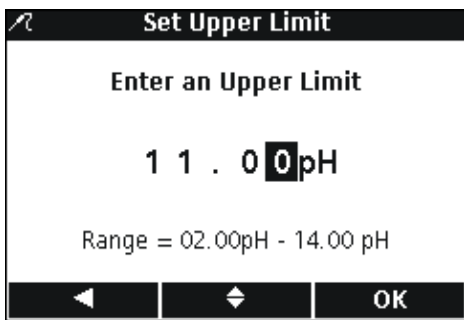
1. With **Measurement Options** highlighted in the Modify Current Method menu, press the **GREEN/RIGHT** key under Select.
2. Use the **UP** and **DOWN** keys to select **Measurement Limits**. Press the **GREEN/RIGHT** key under Select.



3. Use the **UP** and **DOWN** keys to select **Lower Limit** or **Upper Limit**. Press the **GREEN/RIGHT** key under Select.



4. **Set Lower Limit:** Use the **UP** and **DOWN** keys to change the limit value. Use the **BLUE/LEFT** key to move to the left. Use the **GREEN/RIGHT** key to move to the right. When the cursor is at the far right, press the **GREEN/RIGHT** key under OK.



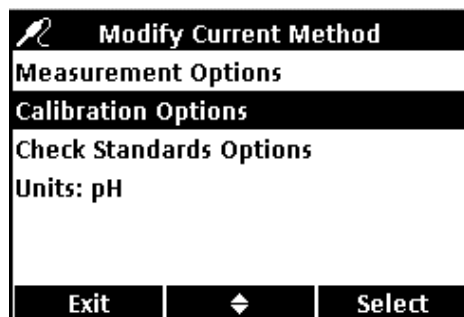
5. **Set Upper Limit:** Use the **UP** and **DOWN** keys to change the limit value. Use the **BLUE/LEFT** key to move to the left. Use the **GREEN/RIGHT** key to move to the right. When the cursor is at the far right, press the **GREEN/RIGHT** key under OK.

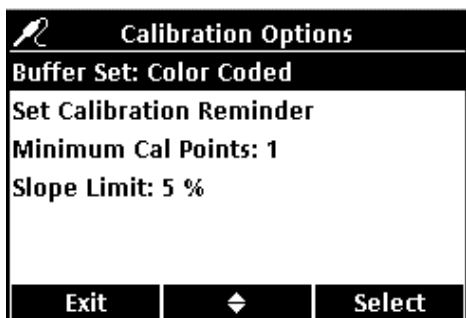
### 6.5.3 Modifying the pH Calibration Options

Edit calibration options to change the specified buffer sets for calibration, calibration reminders, minimum required number of calibration points, and slope acceptance criteria.

To modify the current calibration method options, use the **UP** and **DOWN** keys to highlight **Calibration Options** in the Modify Current Method menu. Press the **GREEN/RIGHT** key under Select.

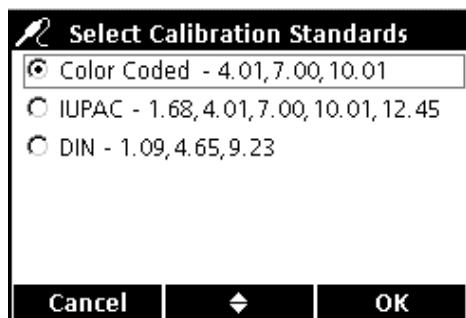
The Calibrations Options menu will appear. Edit the buffer sets, calibration reminder, calibration points, and slope limits using the following steps.



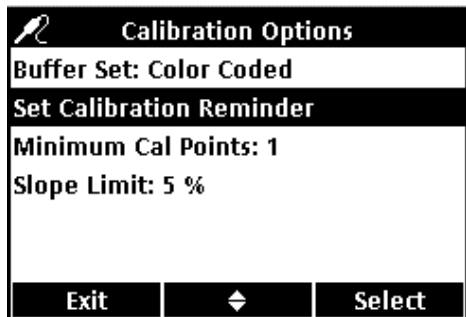


**Editing the Buffer Sets for Automatic Recognition.**

1. Use the **UP** and **DOWN** keys to highlight **Buffer Set**. Press the **GREEN/RIGHT** key under **Select**.

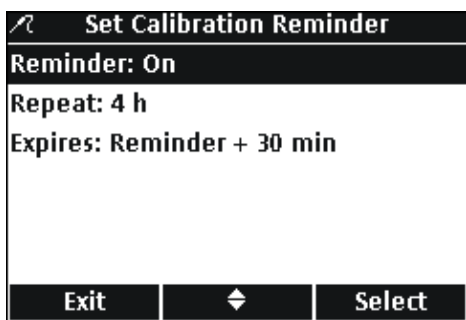


2. Use the **UP** and **DOWN** keys to select the desired buffer set for calibration. Press the **GREEN/RIGHT** key under **OK**. The meter will use these buffers for auto recognition.



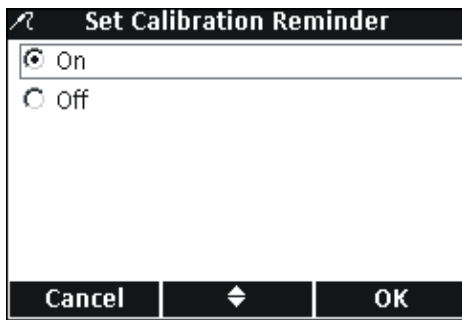
**Editing the Calibration Reminder**

1. Use the **UP** and **DOWN** keys to highlight **Set Calibration Reminder**. Press the **GREEN/RIGHT** key under **Select**.

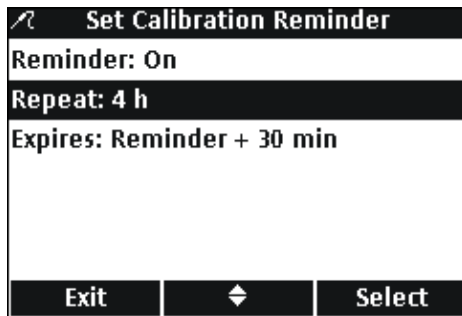


To turn Reminder On or Off:

2. Use the **UP** and **DOWN** keys to highlight **Reminder**. Press the **GREEN/RIGHT** key under **Select**.

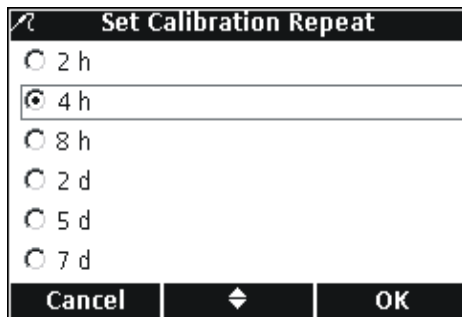


3. Use the **UP** and **DOWN** keys to select **On** or **Off**. Press the **GREEN/RIGHT** key under **OK**.

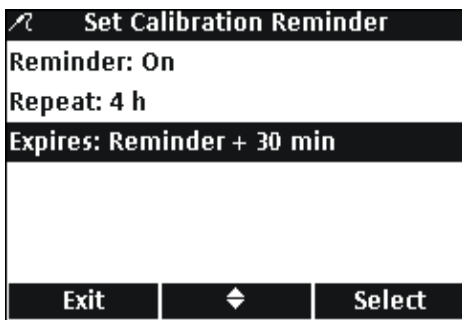


To set the Reminder frequency:

4. Use the **UP** and **DOWN** keys to highlight **Repeat**. Press the **GREEN/RIGHT** key under **Select**.

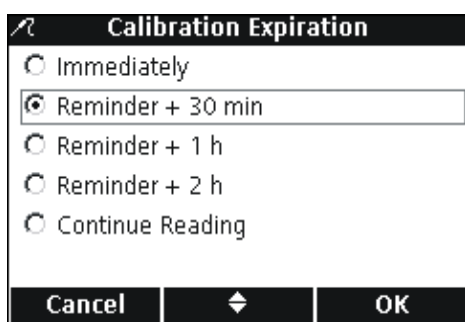


5. Use the **UP** and **DOWN** keys to select the desired reminder frequency. Press the **GREEN/RIGHT** key under **OK**.



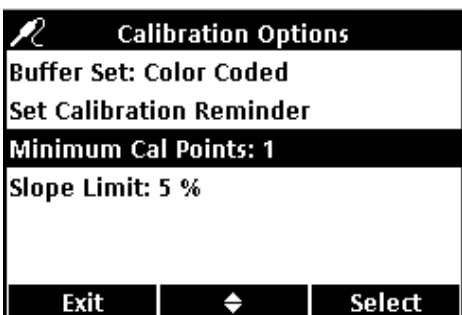
To edit the calibration expiration:

6. Use the **UP** and **DOWN** keys to highlight **Expires**. Press the **GREEN/RIGHT** key under **Select**.



- Use the **UP** and **DOWN** keys to select how long after the reminder the calibration will expire. Press the **GREEN/RIGHT** key under OK.

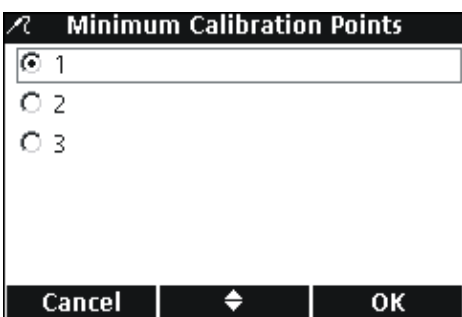
**Note:** The meter cannot be used for measuring samples after the calibration expires unless the Continue Reading setting is enabled.



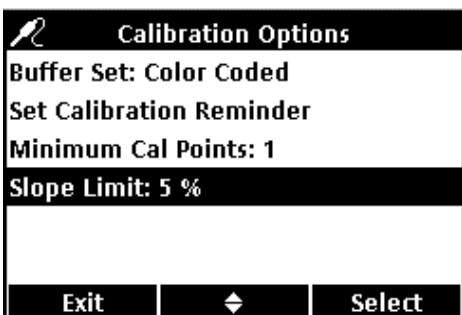
### Editing the Calibration Points

The meter can be set to require a minimum number of calibration points be entered before calibration can be completed. To set the minimum number of buffers that are required to complete calibration:

- Use the **UP** and **DOWN** keys to highlight **Minimum Cal Points**. Press the **GREEN/RIGHT** key under Select.



- Use the **UP** and **DOWN** keys to select the desired minimum number of calibration points. Press the **GREEN/RIGHT** key under OK.

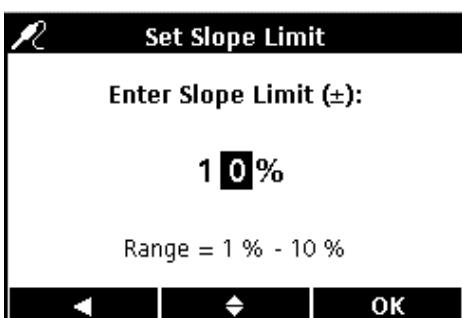


### Setting the Calibration Slope Limit

The meter can reject a calibration if the calibration slope falls outside of specified limits. Specify a narrower tolerance to achieve a more accurate calibration.

To change the acceptable slope tolerance for calibration:

- Use the **UP** and **DOWN** keys to highlight **Slope Limit**. Press the **GREEN/RIGHT** key under Select.
- Use the **UP** and **DOWN** keys to enter a value for the acceptable slope limit. Use the **BLUE/LEFT** key to move to the left. Use the **GREEN/RIGHT** key to move to the right. When the cursor is at the far right, press the **GREEN/RIGHT** key under OK.

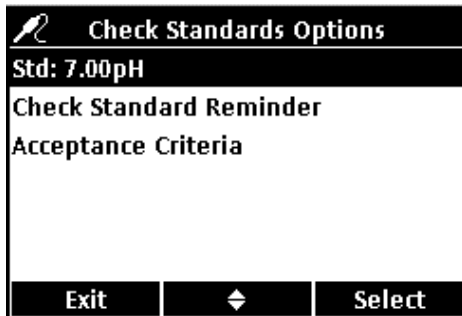


The meter will reject a calibration if the slope falls outside of the specified slope limit.

## 6.5.4 Modifying the pH Check Standard Options

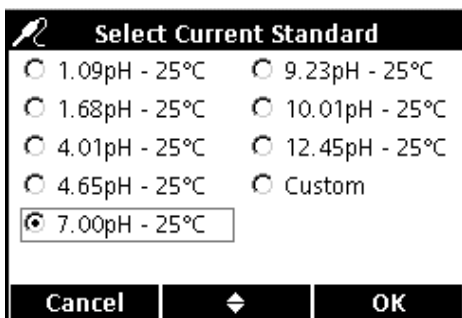
The buffer solution that is used for check standard measurements can be changed.

### 6.5.4.1 Selecting a Check Standard Buffer



From the Modify Current Method screen:

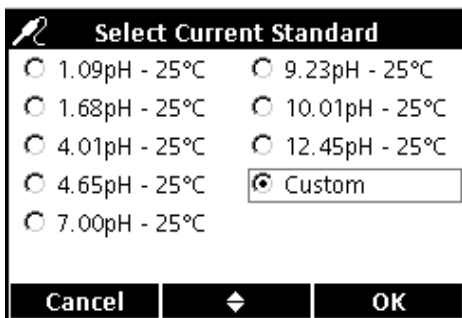
1. Use the **UP** and **DOWN** keys to highlight **Check Standard Options** (not pictured).
2. Use the **UP** and **DOWN** keys to highlight **Std:**. Press the **GREEN/RIGHT** key under Select to select the buffer to be used.



3. Use the **UP** and **DOWN** keys to select a temperature-compensated buffer. Press the **GREEN/RIGHT** key under OK.

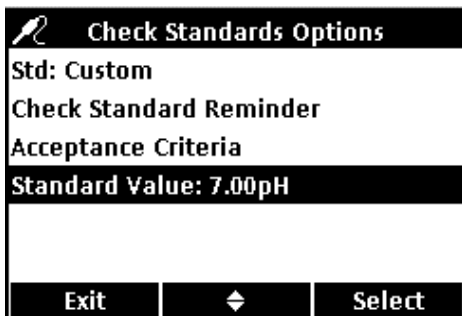
**Important Note:** selecting a temperature-compensated buffer is strongly recommended whenever check standards cannot be measured at known, consistent, and constant temperatures.

### 6.5.4.2 Using a Custom Check Standard



1. To use a custom standard, use the **UP** and **DOWN** keys to highlight **Custom**. Press the **GREEN/RIGHT** key under OK.

**Note:** If a custom standard is selected, the pH value is not corrected for temperature.

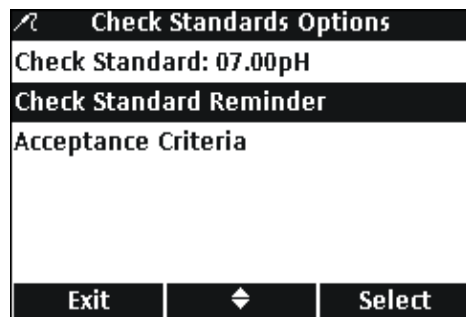


2. If Custom standard is selected in step 1, use the **UP** and **DOWN** keys to highlight **Standard Value**. Press the **GREEN/RIGHT** key under Select.



3. If a custom standard is chosen, use the **UP** and **DOWN** keys to enter a value to be used for the custom check standard. Use the **BLUE/LEFT** key to move to the left. Use the **GREEN/RIGHT** key to move to the right. When the cursor is at the far right, press the **GREEN/RIGHT** key under OK.

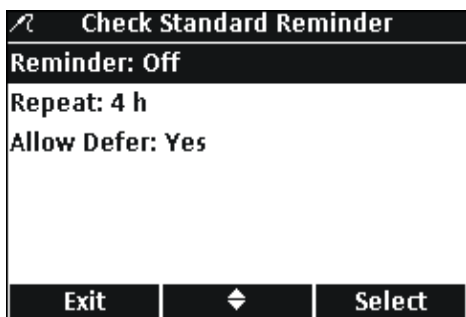
### 6.5.4.3 Editing the Check Standard Reminder Options



To turn the Check Standard reminder on or off, set the frequency of the check standard reminder, and edit the defer option refer to the following steps.

To edit Check Standard Reminder Options:

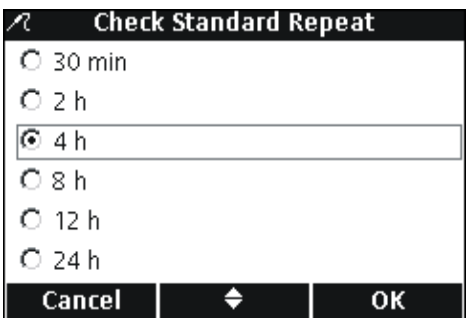
1. Use the **UP** and **DOWN** keys to highlight **Check Standard Reminder**. Press the **GREEN/RIGHT** key under Select.



2. To turn the Check Standard on or off, use the **UP** and **DOWN** keys to highlight **Reminder**. Press the **GREEN/RIGHT** key under Select.



3. Use the **UP** and **DOWN** keys to select **On** or **Off**. Press the **GREEN/RIGHT** key under OK.



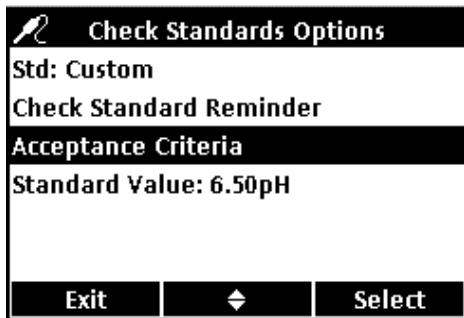
4. To set the Check Standard Reminder frequency, use the **UP** and **DOWN** keys to select **Repeat**. Press the **GREEN/RIGHT** key under Select.
5. Use the **UP** and **DOWN** keys to select the reminder frequency. Press the **GREEN/RIGHT** key under OK.



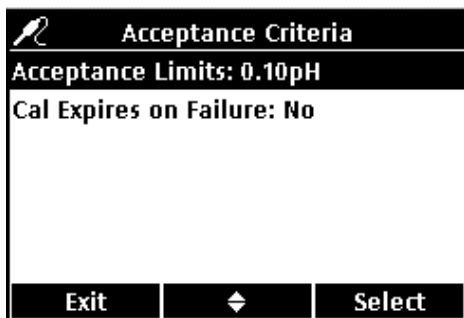


6. To edit the defer options, use the **UP** and **DOWN** keys to select **Allow Defer**. Press the **GREEN/RIGHT** key under Select.
7. Use the **UP** and **DOWN** keys to select **Yes** or **No**. Press the **GREEN/RIGHT** key under OK.

#### 6.5.4.4 Editing the Acceptance Criteria for Check Standards

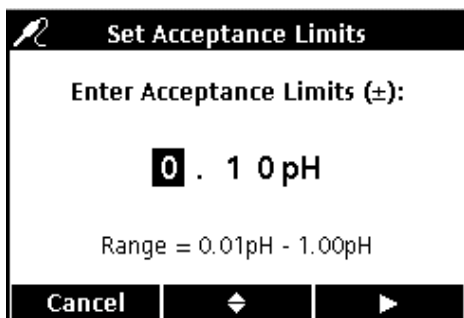


1. Use the **UP** and **DOWN** keys to highlight **Acceptance Criteria**. Press the **GREEN/RIGHT** key under Select.

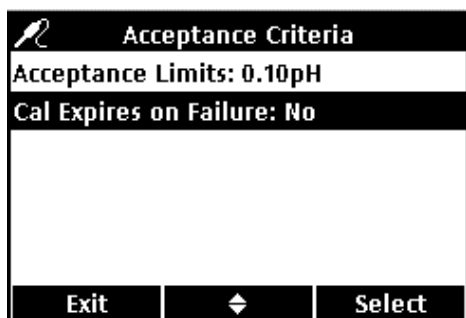


Refer to the following steps to edit the Check Standard acceptance criteria or edit whether a failed Check Standard requires re-calibration before continuing measurements.

1. Use the **UP** and **DOWN** keys to highlight **Acceptance Limits**. Press the **GREEN/RIGHT** key under Select.



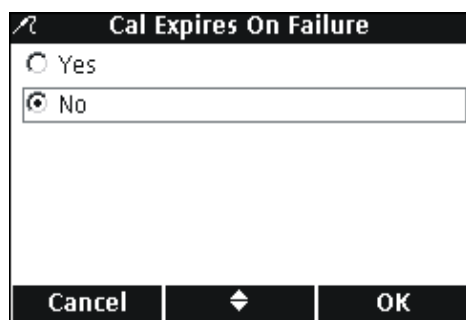
2. Use the **UP** and **DOWN** keys to enter a tolerance (as  $\pm$ pH) that the Check Standard must fall within. Use the **BLUE/LEFT** key to move to the left. Use the **GREEN/RIGHT** key to move to the right. When the cursor is at the far right, press the **GREEN/RIGHT** key under OK.



**Acceptance Criteria**  
Acceptance Limits: 0.10pH  
Cal Expires on Failure: No

Exit    ◆    Select

3. Use the **UP** and **DOWN** keys to highlight **Cal Expires on Failure**. Press the **GREEN/RIGHT** key under Select.



**Cal Expires On Failure**  
 Yes  
 No

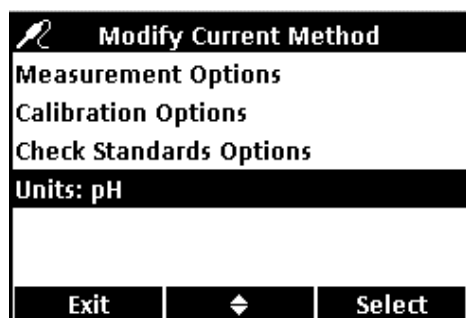
Cancel    ◆    OK

4. Use the **UP** and **DOWN** keys to select **Yes** or **No**. Press the **GREEN/RIGHT** key under OK.

When set to Yes, the meter must be calibrated when a Check Standard falls outside of the specified acceptance limits. No measurements can be taken until the meter is successfully re-calibrated.

When set to No, the meter will operate normally in the measurement mode.

### 6.5.5 Modifying the pH Measurement Units



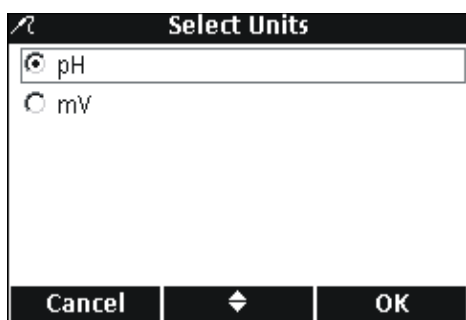
**Modify Current Method**  
Measurement Options  
Calibration Options  
Check Standards Options  
Units: pH

Exit    ◆    Select

The meter will display both pH and mV values in the measurement mode.

To change which unit is prominent:

1. Use the **UP** and **DOWN** keys to highlight **Units**. Press the **GREEN/RIGHT** key under Select.



**Select Units**  
 pH  
 mV

Cancel    ◆    OK

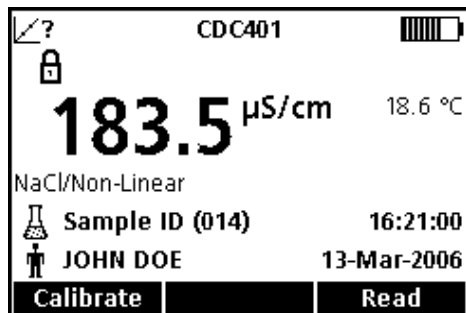
2. Use the **UP** and **DOWN** keys to select **pH** or **mV**. Press the **GREEN/RIGHT** key under OK.

## 7.1 Calibrating the Conductivity Probe

Calibrating a conductivity probe establishes the linear cell constant of the probe. Use a conductivity standard solution to calibrate the IntelliCAL conductivity probe. The conductivity standard can be specified in the Conductivity Options menu (see [section 7.4 on page 66](#)).

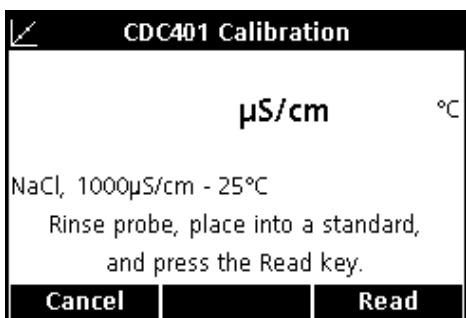
1. Press the **BLUE/LEFT** key under Calibrate.

**Note:** If using the HQ40d meter with two probes, the display must be in single screen mode.

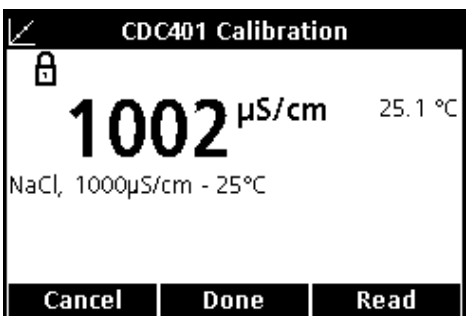


2. The display will show the required conductivity standard solution. Rinse the probe and place it in the standard solution.

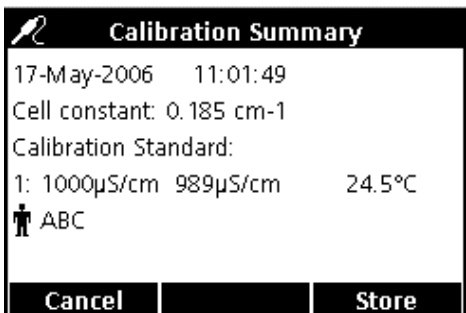
**Note:** All conductivity calibrations are performed using conductivity units ( $\mu\text{S}/\text{cm}$ ,  $\text{mS}/\text{cm}$ ) regardless of whether conductivity, resistivity, salinity, or total dissolved solids (TDS) is measured.



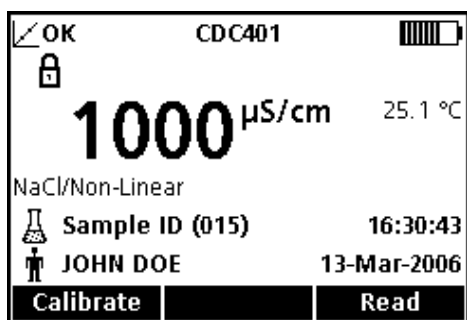
3. Press the **GREEN/RIGHT** key under Read. The meter will calculate the cell constant based on the selected calibration standard.



4. When the reading is stable, the display will show the temperature corrected value of the conductivity reading of the standard solution.
5. Press the **UP** key under Done.



6. The Calibration Summary will appear. Press the **GREEN/RIGHT** key under Store to accept the calibration and return to the measurement mode. The calibration is stored in the meter data log. If using the HQ40d meter, the calibration information is also sent to a PC/printer/flash memory stick if connected.

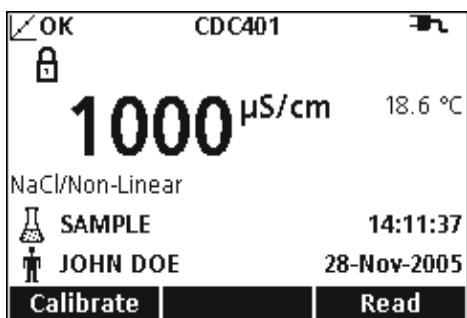


- When the calibration is successful, the display will show OK in the upper left corner. A question mark will be displayed if a calibration has expired or if a check standard has failed or been delayed.

## 7.2 Taking a Conductivity, Salinity, Resistivity, or TDS Measurement

If complete traceability is required, enter an Operator ID and Sample ID before measuring samples: be sure the Operator ID and Sample ID shown in the display are current. Press the **OPERATOR ID** and **SAMPLE ID** keys to update.

**Note:** The default setting for Measurement Mode is “Press to Read”. If a different mode is required, change the Measurement Mode (see [section 9.5 on page 94](#)).



- Place the conductivity probe into the sample.
- Press the **GREEN/RIGHT** key under Read.
- The display will show “Stabilizing...” and a progress bar will fill from 0 to 100% as the probe stabilizes in the sample. The lock icon will appear and the result will be stored automatically in the 500-result data log.
- This screen is an example of a conductivity measurement displayed in conductivity units. Repeat this procedure to take additional measurements. See [Figure 17 on page 64](#), [Figure 18](#), and [Figure 19 on page 65](#).

**Note:** When an IntelliCAL conductivity probe is attached to the meter, the measurement results will be displayed in units of conductivity, salinity, resistivity, or total dissolved solids (TDS). To change the measurement units, save the default method under a new name, and select the unit of choice in the new method.

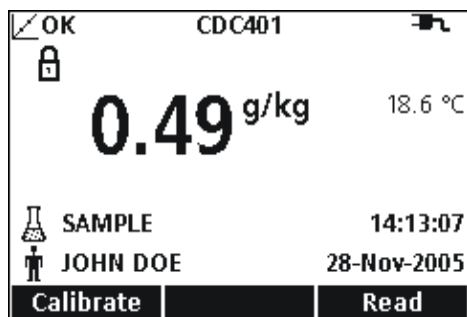


Figure 17 Example of Conductivity Measurement Displayed in Salinity Units

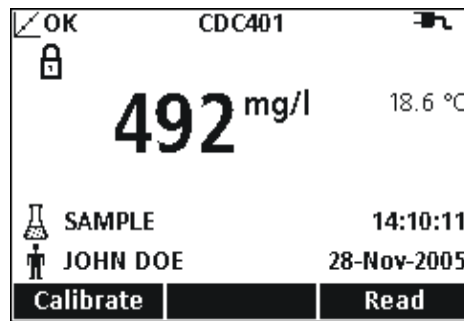


Figure 18 Example of Conductivity Measurement Displayed in TDS Units

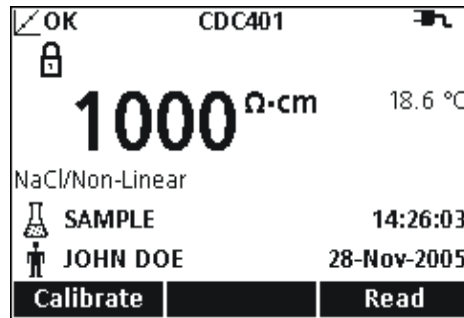


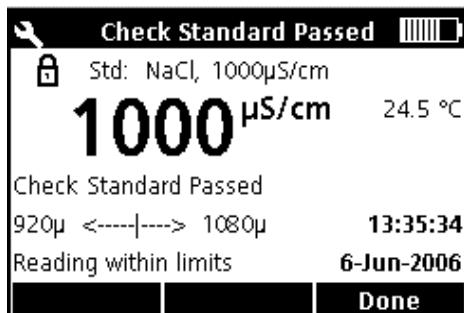
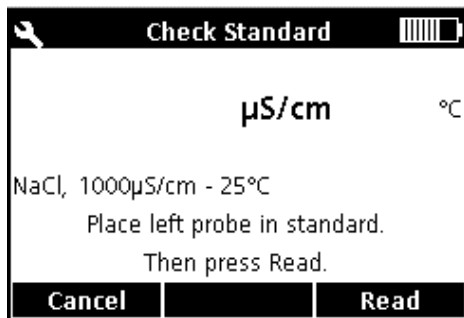
Figure 19 Example of Conductivity Measurement Displayed in Resistivity Units

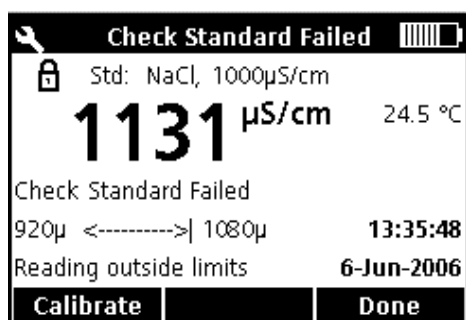
### 7.3 Running Check Standards Manually or Automatically

When the Check Standard reminder is on, the meter will automatically display the Check Standard screen. The check standard can either be measured immediately, or the measurement can be delayed until a later time.

To measure the Check Standard:

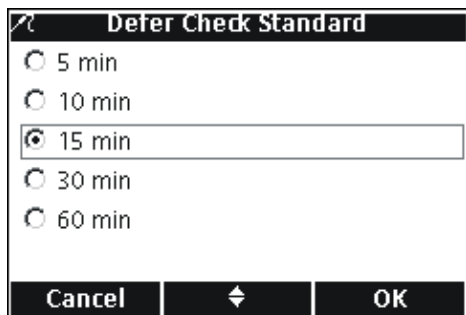
1. Obtain the conductivity standard solution specified for the check standard. The conductivity solution to be used is shown on the display.
2. Place the probe in the conductivity standard.
3. Press the **GREEN/RIGHT** key under Read.
4. The display will show the value of the check standard and either "Check Standard Passed" or "Check Standard Failed".
5. If "Check Standard Passed" is displayed, the reading is verified to be accurate. Press the **GREEN/RIGHT** key under Done to proceed with sample measurements.





6. If “Check Standard Failed” is displayed, the measurement is outside of the accepted limits.
7. If the acceptance criteria does not allow failed Check Standards, all results will be displayed with the **CALIBRATION ?** icon, and will be stored with a flag indicating a suspect calibration. Press the **BLUE/LEFT** key under Calibrate and follow the steps for calibration.

### 7.3.0.1 Deferring a Check Standard



A Check Standard Reminder can be deferred to a later time. This option is set within the Method to allow for supervisor control of this function. A password may be required to change this setting.

To defer the Check Standard measurement to a later time:

1. Press the **UP** key under Defer.
2. Use the **UP** and **DOWN** keys to select when the next reminder will be displayed.
3. Press the **GREEN/RIGHT** key under OK. The Check Standard reminder will re-appear after the selected time has passed.

## 7.4 Setting the Conductivity Method



The Conductivity Method menu is available via the **METER OPTIONS/PARAMETER METHODS** key when Access Control is off, or when a valid password is entered. A conductivity probe must be connected to the meter to change these options.

[Table 4](#) outlines the menu options for Conductivity Method. These options do not need to be changed if the default method is used. The Modify Current Method submenus and default settings are described in detail in [section 7.5 on page 67](#).

The HQ series meters contain a default method for conductivity with settings for measurement, calibration, check standards, and units. The default settings cannot be changed.

To enter options that are different from the default settings, a new method must be created and then modified.

**Table 4 Conductivity Parameter Method Menu Summary**

CONDUCTIVITY MAIN MENU	CONDUCTIVITY SUBMENU
Current Method	Set Current Method
Save Current Method As	New Method Name
Modify Current Method	Parameter
	Measurement Options
	Calibration Options
	Check Standards Options
Delete a Method	Delete a Method

## 7.5 Modify Current Method Menu for Conductivity Summary

CONDUCTIVITY OPTION	AVAILABLE SELECTIONS	DEFAULT SETTING
Parameter	Conductivity Salinity TDS Resistivity	Conductivity
<b>Measurement Options</b>		
Units	Conductivity: Auto range between $\mu\text{S/cm}$ and $\text{mS/cm}$ , fixed $\mu\text{S/cm}$ , or fixed $\text{mS/cm}$ Salinity: ppt, g/kg, <unitless> TDS: no options other than mg/L Resistivity: no options other than Ohm-cm	Auto range (conductivity) ppt (salinity)
Measurement Limits (conductivity, salinity, TDS, and resistivity respectively)	Lower Limit: 0.01 $\mu\text{S/cm}$ , 0 ppt, 0 mg/L, 5 Ohm-cm Upper Limit: 200,000 $\mu\text{S/cm}$ , 40 ppt, 50,000 mg/L, $5 \times 10^7$ Ohm-cm	Lower: 0.01 $\mu\text{S/cm}$ Upper: 200,000 $\mu\text{S/cm}$
Temperature Correction <sup>1</sup>	None Linear (conductivity 1.9%/C) Non-Linear/NaCl Natural Water	Parameter Based Defaults
Correction Factor <sup>1,2</sup>	Enter Factor (Available only for conductivity and resistivity with linear temperature correction)	1.90%/°C
Reference Temperature <sup>1,3</sup>	20 °C 25 °C	25 °C
<b>Calibration Options</b>		
Set Calibration Standard	1 D KCl, 111.3 mS/cm, 25 °C 0.1 D KCl, 12.85 mS/cm, 25 °C 0.01 D KCl, 1.41 mS/cm, 25 °C 0.1 M KCl, 12,880 $\mu\text{S/cm}$ , 25 °C 0.01 M KCl, 1413 $\mu\text{S/cm}$ , 25 °C 0.001 M KCl, 146.93 $\mu\text{S/cm}$ , 25 °C NaCl, 18 mS/cm, 25 °C NaCl, 1000 $\mu\text{S/cm}$ , 25 °C NaCl, 25 $\mu\text{S/cm}$ , 25 °C NaCl, 0.05%, 1015 $\mu\text{S/cm}$ , 25 °C Seawater Custom	NaCl, 1000 $\mu\text{S/cm}$ , 25 °C
Calibration Reminder	Reminder: On or Off Repeat: 30 min, 2 h, 4 h, 8 h, 2 d, 5 d, 7 d Expires: Immediately, Reminder +30 min, + 1 h, + 2 h, continue reading	Reminder: Off Repeat: 8h Expires: +30 min
Standard Value	(For custom calibration standard only)	User Selectable
Reference Temperature	(For custom calibration standard only)	User Selectable
Temperature Correction	(For custom calibration standard only)	User Selectable
<b>Check Standards Options</b>		
Check Standard Value	Enter value	1413 $\mu\text{S/cm}$
Check Standard Reminder	Reminder: On or Off Repeat: Off, 0.5 h, 2 h, 4h, 8h, 12 h, 24 h Allow Defer: Yes or No	Reminder: Off Repeat: 4h Defer: No

## 7.5 Modify Current Method Menu for Conductivity Summary (continued)

CONDUCTIVITY OPTION	AVAILABLE SELECTIONS	DEFAULT SETTING
Acceptance Criteria	Acceptance Limits: $\pm 1$ to $\pm 10\%$ Calibration Expires On Failure: Yes or No	$\pm 5\%$ Off
Standard Value	(For Custom Standard Only)	User Selectable
Reference Temperature	(For Custom Standard Only)	User Selectable
Temperature Correction	(For Custom Standard Only)	User Selectable

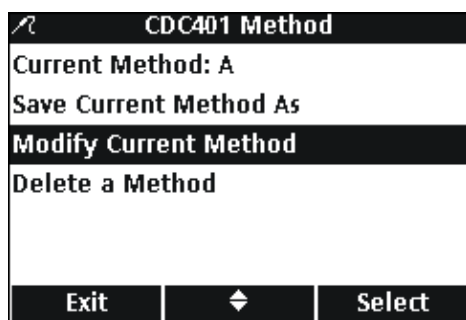
<sup>1</sup> Automatic temperature correction for salinity or TDS.

<sup>2</sup> Available for conductivity and resistivity with linear temperature correction only.

<sup>3</sup> Available for conductivity and resistivity with linear on non-linear/NaCl temperature correction only.

### 7.5.1 Modifying a Conductivity Method

A method for conductivity can be edited when Access Control is off, or when a valid password is entered.

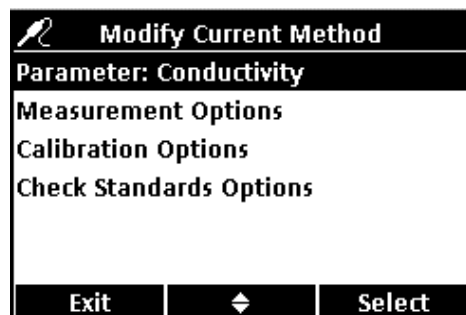


- From the **Conductivity Parameter Methods** menu, use the **UP** and **DOWN** keys to highlight **Modify Current Method**. Press the **GREEN/RIGHT** key under Select.

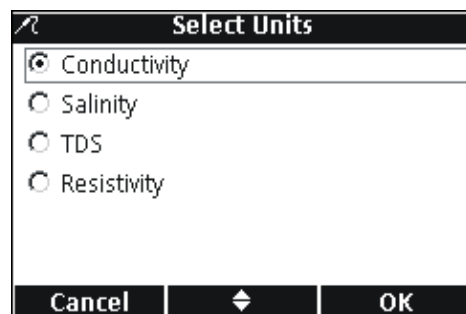
**Note:** The default method cannot be modified or deleted, but can be saved with a new name (Save Current Method As) and then modified.

### 7.5.2 Modifying the Conductivity Parameter

Change the parameter to measure Conductivity, TDS, Salinity, or Resistivity.



- With **Parameter** highlighted in the **Modify Current Method** menu, press the **GREEN/RIGHT** key under Select.



- Use the **UP** and **DOWN** keys to select the desired parameter. Press the **GREEN/RIGHT** key under OK.

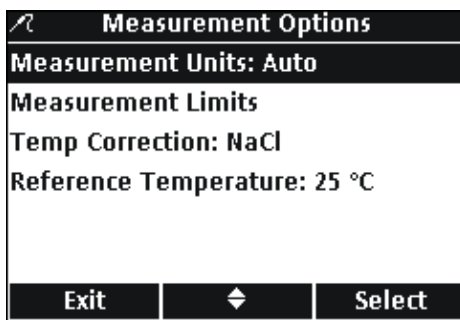
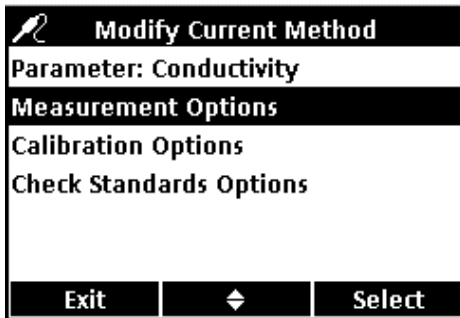


### 7.5.3 Modifying the Conductivity Measurement Options

Use Measurement Options to change units for conductivity upper and lower measurement limits, or temperature correction for conductivity or resistivity.

1. Use the **UP** and **DOWN** keys to highlight **Measurement Options** in the Modify Current Method menu. Press the **GREEN/RIGHT** key under Select.

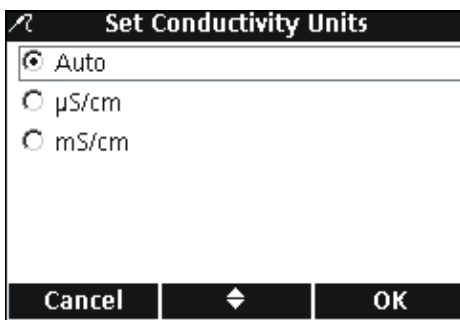
The available Measurement Options will vary depending on which parameter is selected.



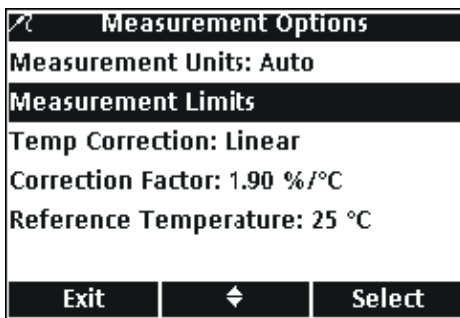
#### Changing Measurement Units

The units for conductivity can be fixed or “auto-scaling”. The units for Salinity can also be changed. To change the units for either parameter:

1. Use the **UP** and **DOWN** keys to highlight **Measurement Units**. Press the **GREEN/RIGHT** key under Select.



2. Use the **UP** and **DOWN** keys to select the desired units. Press the **GREEN/RIGHT** key under OK.

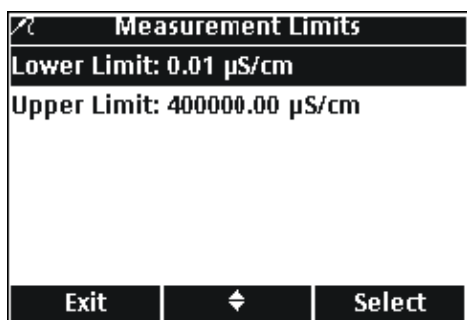


#### Changing Measurement Limits

Upper and lower limits can be set for conductivity, salinity, TDS, and resistivity. To change limits:

1. Use the **UP** and **DOWN** keys to select **Measurement Limits**. Press the **GREEN/RIGHT** key under Select.

## Conductivity Operation and Methods



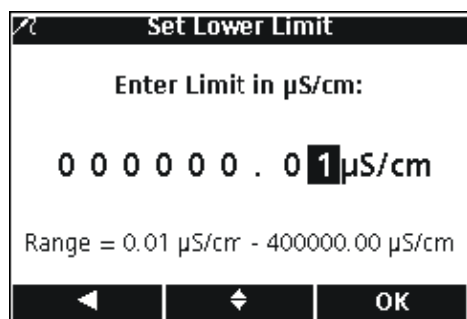
Measurement Limits

Lower Limit: 0.01  $\mu\text{S}/\text{cm}$

Upper Limit: 400000.00  $\mu\text{S}/\text{cm}$

Exit     $\blacktriangleleft$     Select

2. Use the **UP** and **DOWN** keys to select **Lower Limit** or **Upper Limit**. Press the **GREEN/RIGHT** key under Select.



Set Lower Limit

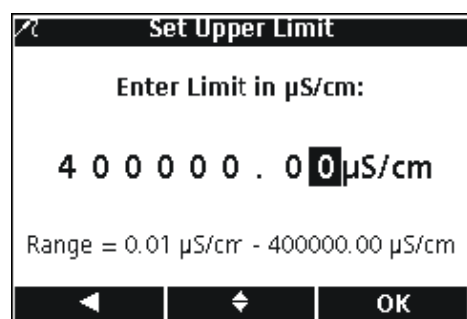
Enter Limit in  $\mu\text{S}/\text{cm}$ :

0 0 0 0 0 0 . 0 1  $\mu\text{S}/\text{cm}$

Range = 0.01  $\mu\text{S}/\text{cm}$  - 400000.00  $\mu\text{S}/\text{cm}$

$\blacktriangleleft$      $\blacktriangleup$     OK

3. **Set Lower Limit:** Use the **UP** and **DOWN** keys to change the limit value. Use the **BLUE/LEFT** key to move to the left. Use the **GREEN/RIGHT** key to move to the right. When the cursor is at the far right, press the **GREEN/RIGHT** key until OK replaces the right arrow in the function bar. Select **OK** to complete the entry.



Set Upper Limit

Enter Limit in  $\mu\text{S}/\text{cm}$ :

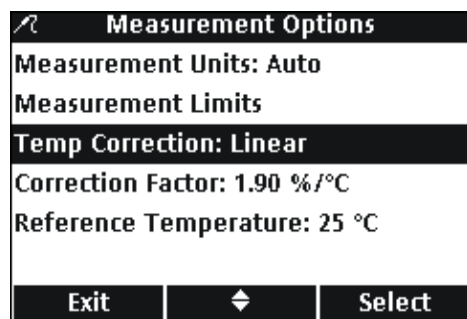
4 0 0 0 0 0 . 0 0  $\mu\text{S}/\text{cm}$

Range = 0.01  $\mu\text{S}/\text{cm}$  - 400000.00  $\mu\text{S}/\text{cm}$

$\blacktriangleleft$      $\blacktriangleup$     OK

4. **Set Upper Limit:** Use the **UP** and **DOWN** keys to change the limit value. Use the **BLUE/LEFT** key to move to the left. Use the **GREEN/RIGHT** key to move to the right. When the cursor is at the far right, press the **GREEN/RIGHT** key until OK replaces the right arrow in the function bar. Select **OK** to complete the entry.

*Note: Upper and lower limits only use conductivity units.*



Measurement Options

Measurement Units: Auto

Measurement Limits

Temp Correction: Linear

Correction Factor: 1.90  $\%/^{\circ}\text{C}$

Reference Temperature: 25  $^{\circ}\text{C}$

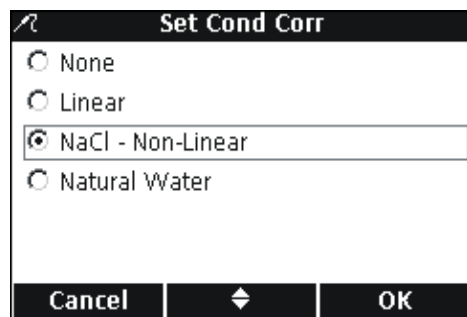
Exit     $\blacktriangleup$     Select

### Changing Temperature Correction

Temperature correction options are available for conductivity or resistivity.

To change the Temperature Correction Options:

1. Use the **UP** and **DOWN** keys to highlight **Temperature Correction**. Press the **GREEN/RIGHT** key under Select.
2. Use the **UP** and **DOWN** keys to select the temperature correction to be used. Press the **GREEN/RIGHT** key until OK replaces the right arrow in the function bar. Select **OK** to complete the entry.



Set Cond Corr

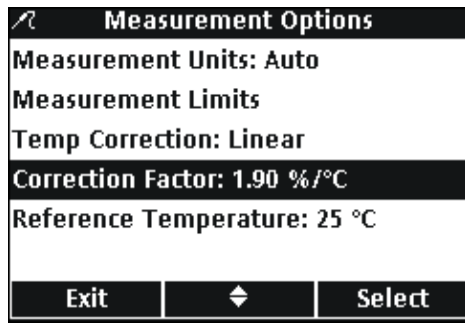
None

Linear

NaCl - Non-Linear

Natural Water

Cancel     $\blacktriangleup$     OK

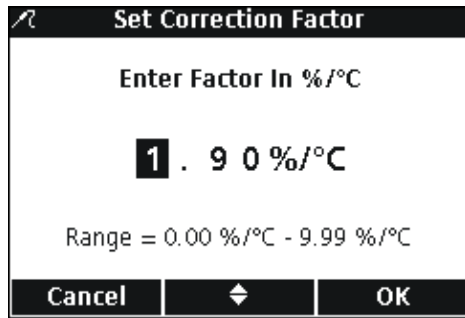


**Changing the Correction Factor**

When the temperature correction is set to linear, the correction factor can be changed.

To change the Correction Factor:

1. Use the **UP** and **DOWN** keys to highlight **Correction Factor**. Press the **GREEN/RIGHT** key under Select.
2. Use the **UP** and **DOWN** keys to change the correction factor. Use the **BLUE/LEFT** key to move to the left. Use the **GREEN/RIGHT** key to move to the right. When the cursor is at the far right, press the **GREEN/RIGHT** key under OK.

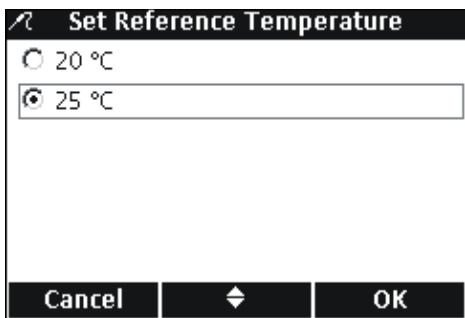
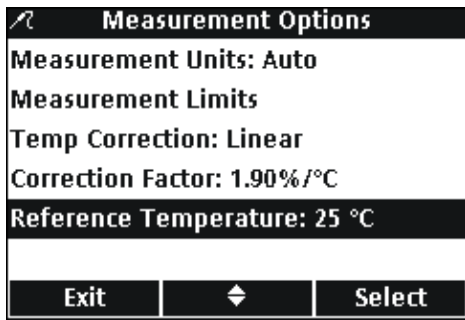


**Changing the Reference Temperature**

The reference temperature can be changed when the temperature correction is set to linear or NaCl/non-linear.

To change the Reference Temperature:

1. Use the **UP** and **DOWN** keys to highlight **Reference Temperature**. Press the **GREEN/RIGHT** key under Select.
2. Use the **UP** and **DOWN** keys to select the reference temperature to be used. Press the **GREEN/RIGHT** key until OK replaces the right arrow in the function bar. Select **OK** to complete the entry.



### 7.5.4 Modifying the Conductivity Calibration Options

**Modify Current Method**  
Parameter: Conductivity  
Measurement Options  
Calibration Options  
Check Standards Options  
Exit    ◀▶    Select

Calibration Options changes the specified conductivity standard for calibration and calibration reminders.

1. Use the **UP** and **DOWN** keys to highlight **Calibration Options**. Press the **GREEN/RIGHT** key under Select.

**Calibration Options**  
Std: NaCl, 1000µS/cm  
Set Calibration Reminder  
Exit    ◀▶    Select

#### Changing the Conductivity Standard

1. Use the **UP** and **DOWN** keys to highlight **Std**. Press the **GREEN/RIGHT** key under Select.

**Select Current Standard**  
 0.01D KCl, 1.41mS/cm - 25°C  
 0.1M KCl, 12880µS/cm - 25°C  
 0.01M KCl, 1413µS/cm - 25°C  
 0.001M KCl, 146.93µS/cm - 25°C  
 NaCl, 18mS/cm - 25°C  
 NaCl, 1000µS/cm - 25°C  
Cancel    ◀▶    OK

2. Use the **UP** and **DOWN** keys to select the calibration standard solution to be used. Press the **GREEN/RIGHT** key under OK.

**Calibration Options**  
Std: NaCl, 1000µS/cm  
Set Calibration Reminder  
Exit    ◀▶    Select

#### Editing the Calibration Reminder

1. Use the **UP** and **DOWN** keys to highlight **Set Calibration Reminder**. Press the **GREEN/RIGHT** key under Select.

**Set Calibration Reminder**  
Reminder: On  
Repeat: 4 h  
Expires: Reminder + 30 min  
Exit    ◀▶    Select

2. To turn Reminder On or Off, use the **UP** and **DOWN** keys to highlight **Reminder**. Press the **GREEN/RIGHT** key under Select.

**Set Calibration Reminder**

On  
 Off

Cancel    ◆    OK

3. Use the **UP** and **DOWN** keys to select **On** or **Off**. Press the **GREEN/RIGHT** key under OK.

**Set Calibration Reminder**

Reminder: On  
Repeat: 4 h  
Expires: Reminder + 30 min

Exit    ◆    Select

4. To set the Calibration Reminder frequency, use the **UP** and **DOWN** keys to highlight **Repeat**. Press the **GREEN/RIGHT** key under Select.

**Set Calibration Repeat**

2 h  
 4 h  
 8 h  
 2 d  
 5 d  
 7 d

Cancel    ◆    OK

5. Use the **UP** and **DOWN** keys to select the desired reminder frequency. Press the **GREEN/RIGHT** key under OK.

**Set Calibration Reminder**

Reminder: On  
Repeat: 4 h  
Expires: Reminder + 30 min

Exit    ◆    Select

6. To edit when the Calibration Reminder expires, use the **UP** and **DOWN** keys to highlight **Expires**. Press the **GREEN/RIGHT** key under Select.

**Calibration Expiration**

Immediately  
 Reminder + 30 min  
 Reminder + 1 h  
 Reminder + 2 h  
 Continue Reading

Cancel    ◆    OK

7. Use the **UP** and **DOWN** keys to select how long after the reminder the calibration will expire. Press the **GREEN/RIGHT** key under OK.

Calibration Options		
Std: Custom		
Set Calibration Reminder		
Standard Value: 1000 $\mu\text{S}/\text{cm}$		
Reference Temperature: 25 $^{\circ}\text{C}$		
Temp Correction: 1.90 $\%/^{\circ}\text{C}$		
Exit	↕	Select

Set Custom Standard		
Enter Standard Value:		
0 0 1 0 0 0 $\mu\text{S}/\text{cm}$		
Range = 000001 $\mu\text{S}/\text{cm}$ - 199999 $\mu\text{S}/\text{cm}$		
←	↕	OK

Calibration Options		
Std: Custom		
Set Calibration Reminder		
Standard Value: 1000 $\mu\text{S}/\text{cm}$		
Reference Temperature: 25 $^{\circ}\text{C}$		
Temp Correction: 1.90 $\%/^{\circ}\text{C}$		
Exit	↕	Select

Set Standard Temperature		
Enter Standard Value in $^{\circ}\text{C}$		
2 5 $^{\circ}\text{C}$		
Range = 00 $^{\circ}\text{C}$ - 99 $^{\circ}\text{C}$		
Cancel	↕	▶

Calibration Options		
Std: Custom		
Set Calibration Reminder		
Standard Value: 1000 $\mu\text{S}/\text{cm}$		
Reference Temperature: 25 $^{\circ}\text{C}$		
Temp Correction: 1.90 $\%/^{\circ}\text{C}$		
Exit	↕	Select

### Editing the Custom Calibration Standard

When **Custom** is selected for the conductivity calibration standard, the concentration, reference temperature, and temperature correction can be set for the calibration standard.

#### STANDARD VALUE

To enter the conductivity Standard Value of the custom calibration solution:

1. Use the **UP** and **DOWN** keys to highlight **Standard Value**. Press the **GREEN/RIGHT** key under Select.
2. Use the **UP** and **DOWN** keys to change the value of conductivity standard for calibration. Use the **BLUE/LEFT** key to move to the left. Use the **GREEN/RIGHT** key to move to the right. When the cursor is at the far right, press the **GREEN/RIGHT** key under OK.

#### REFERENCE TEMPERATURE

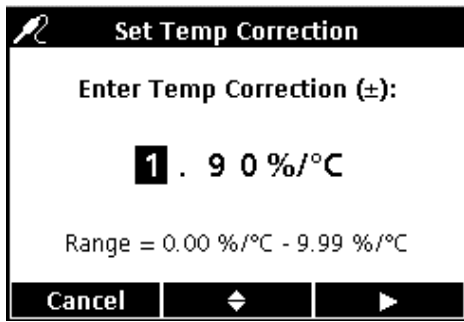
To enter the Reference Temperature for the custom calibration standard:

1. Use the **UP** and **DOWN** keys to highlight **Reference Temperature**. Press the **GREEN/RIGHT** key under Select.
2. Use the **UP** and **DOWN** keys to change the Reference Temperature for calibration. Use the **BLUE/LEFT** key to move to the left. Use the **GREEN/RIGHT** key to move to the right. When the cursor is at the far right, press the **GREEN/RIGHT** key under OK.

#### TEMPERATURE CORRECTION

To enter the Temperature Correction to be used with the custom calibration standard:

1. Use the **UP** and **DOWN** keys to highlight **Temp Correction** ( $\%/^{\circ}\text{C}$ ). Press the **GREEN/RIGHT** key under Select.

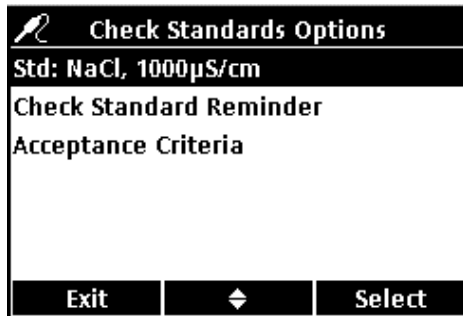
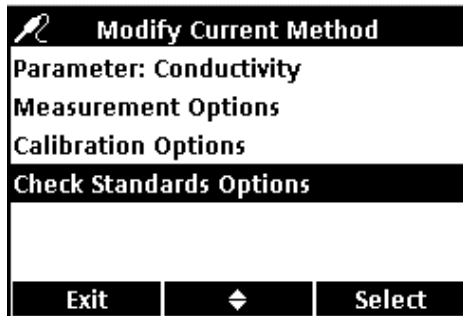


2. Use the **UP** and **DOWN** keys to change the Correction Factor. Use the **BLUE/LEFT** key to move to the left. Use the **GREEN/RIGHT** key to move to the right. When the cursor is at the far right, press the **GREEN/RIGHT** key under OK.

### 7.5.5 Modifying Conductivity Check Standard Options

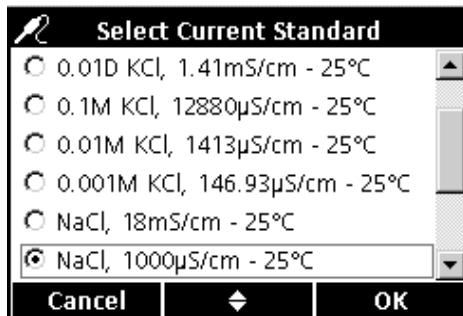
Check Standard Options changes the standard solution used for the check standard, the reminder, and the acceptance criteria.

To edit the Check Standard Options, use the **UP** and **DOWN** keys to highlight **Check Standards Options**. Press the **GREEN/RIGHT** key under Select. The Check Standard menu appears with the following sections.



#### Editing the Check Standard Value

1. To edit the Check Standard value, use the **UP** and **DOWN** keys to highlight **Std:**. Press the **GREEN/RIGHT** key under Select.



2. Use the **UP** and **DOWN** keys to select the Check Standard Value to be used. Press the **GREEN/RIGHT** key under OK.

**Check Standards Options**  
Std: NaCl, 1000µS/cm  
**Check Standard Reminder**  
Acceptance Criteria  
Exit    ⇅    Select

**Check Standard Reminder**  
Reminder: On  
Repeat: 2 h  
Allow Defer: Yes  
Exit    ⇅    Select

**Set Check Std Reminder**  
 On  
 Off  
Cancel    ⇅    OK

**Check Standard Repeat**  
 30 min  
 2 h  
 4 h  
 8 h  
 12 h  
 24 h  
Cancel    ⇅    OK

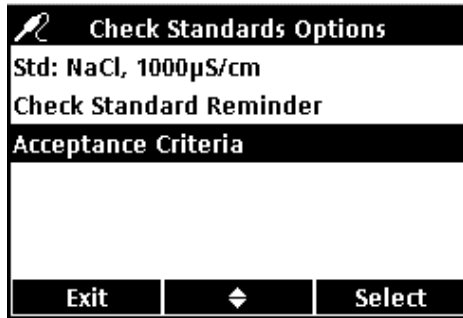
**Allow Defer**  
 Yes  
 No  
Cancel    ⇅    OK

### Editing the Check Standard Reminder

Refer to the following steps to turn the Check Standard Reminder on or off, to set the Check Standard repeat, and to defer the Check Standard.

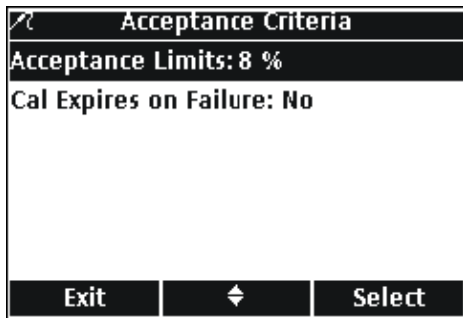
1. Use the **UP** and **DOWN** keys to highlight **Check Standard Reminder**. Press the **GREEN/RIGHT** key under **Select**.
2. To turn Check Standard Reminder on or off, use the **UP** and **DOWN** keys to highlight **Reminder**. Press the **GREEN/RIGHT** key under **Select**.
3. Use the **UP** and **DOWN** keys to select **On** or **Off**. Press the **GREEN/RIGHT** key under **OK**.
4. To set the Check Standard Reminder repeat, use the **UP** and **DOWN** keys to highlight **Repeat**. Press the **GREEN/RIGHT** key under **Select**.
5. Use the **UP** and **DOWN** keys to select the desired reminder frequency. Press the **GREEN/RIGHT** key under **OK**.
6. To edit the Allow Defer option, use the **UP** and **DOWN** keys to highlight **Allow Defer**. Press the **GREEN/RIGHT** key under **Select**. The defer option allows the operator to continue with sample measurements instead of measuring a check standard when the reminder appears.
7. Use the **UP** and **DOWN** keys to select **Yes** or **No**. Press the **GREEN/RIGHT** key under **OK**.



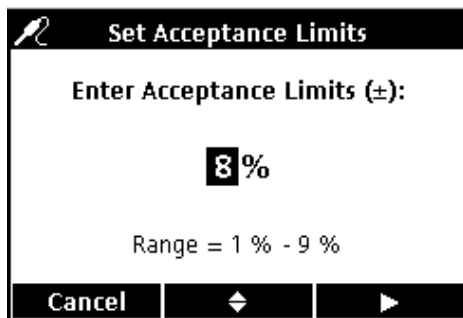


## Editing the Acceptance Criteria for Check Standards

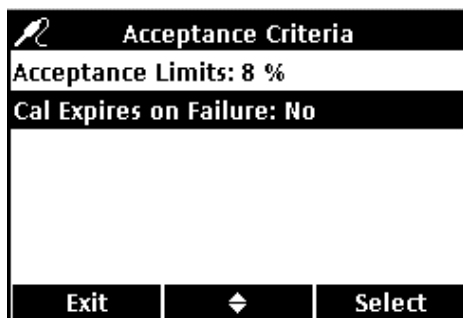
1. Use the **UP** and **DOWN** keys to highlight **Acceptance Criteria**. Press the **GREEN/RIGHT** key under Select.



2. To edit Acceptance Limits, use the **UP** and **DOWN** keys to highlight **Acceptance Limits**. Press the **GREEN/RIGHT** key under Select.



3. Use the **UP** and **DOWN** keys to enter a percent range that the Check Standard must fall within. Use the **BLUE/LEFT** key to move to the left. Use the **GREEN/RIGHT** key to move to the right. When the cursor is at the far right, press the **GREEN/RIGHT** key under OK.



4. To edit the result of a failed Check Standard, use the **UP** and **DOWN** keys to highlight **Cal Expires on Failure**. Press the **GREEN/RIGHT** key under Select.



5. Use the **UP** and **DOWN** keys to select **Yes** or **No**. Press the **GREEN/RIGHT** key under OK.

When set to Yes, the meter must be re-calibrated when a Check Standard falls outside of the specified acceptance limits. If the meter is not re-calibrated, each result will be displayed with the **CALIBRATION ?** icon and stored with a flag indicating a questionable calibration.

When set to No, the meter will operate normally in the measurement mode.

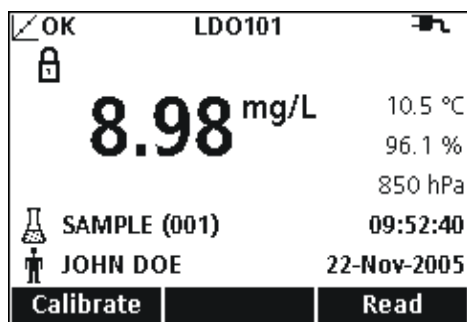


## 8.1 Taking a Dissolved Oxygen Measurement

If complete traceability is required, enter a Sample ID and Operator ID before measuring.

**Note:** The default setting for Measurement Mode is "Press to Read". To change the mode, see Measurement Mode in [section 9.5 on page 94](#).

**Important Note:** A count down message appears on the screen thirty days before the sensor-cap expiration date of the LDO IntelliCAL probe. This message will be displayed until there are zero days remaining and the sensor cap must be replaced. All measurements taken after the sensor cap expiration date appear with the calibration ? icon at the top left corner of the screen.



1. Place the LDO probe into the sample.
2. Press the **GREEN/RIGHT** key under Read.
3. The display will show "Stabilizing..." and a progress bar will fill from 0 to 100% as the probe stabilizes in the sample. When the result has stabilized, the lock icon will appear and the result will be stored automatically in the data log.
4. To make another measurement, repeat this procedure.

The display will also show the temperature and pressure. If a salinity correction was entered, the correction will appear on the display.

## 8.2 Calibrating the LDO Probe

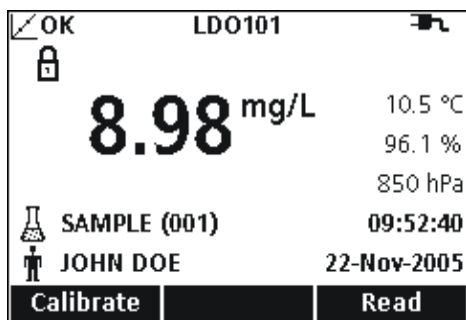
**Important Note:** Factory calibration is the default setting. Factory calibration coefficients are stored in the LDO IntelliCAL probe iButton®\*. Each lot of LDO sensor caps is factory calibrated. Performance will vary slightly as a function of usage history. For best performance, a one-time calibration initialization can be performed when a new sensor is installed. Additional calibrations can be performed at the operator's discretion but are not required. Manually calibrating the LDO probe will require creating and modifying a new method (see [section 8.4 on page 82](#)).

LDO calibration can be performed manually using one of two standards:

- Water-saturated air (recommended). For example, use a bottle with a narrow neck such as a BOD bottle (Cat. No. 621-00). Add a small amount (1-cm) of water to the bottle, stopper and shake vigorously for several minutes, then insert the probe.
- A water sample with a known dissolved oxygen concentration. The concentration must be determined by Winkler titration, or by calculation of a saturated-air water sample using existing pressure, temperature, and salinity conditions.

**Note:** Modify the LDO Method to use a water sample as a standard.

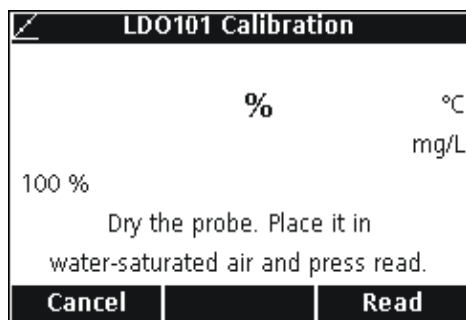
\* iButton is a registered trademark of Maxim Integrated Products, Inc.



To calibrate using water-saturated air:

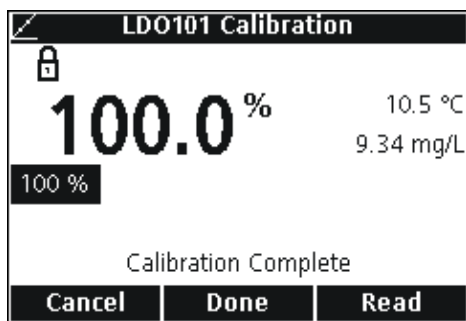
1. Press the **BLUE/LEFT** key under Calibrate.

*Note: If using the HQ40d meter with two probes, the display must be in single screen mode.*

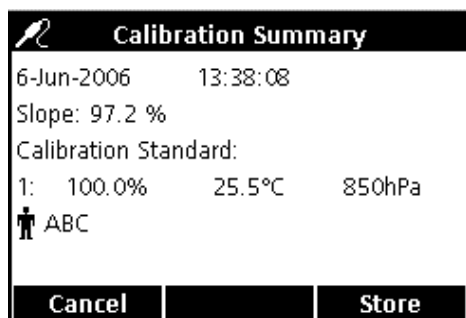


2. Dry the probe and place it in the calibration chamber.
3. Press the **GREEN/RIGHT** key under Read.

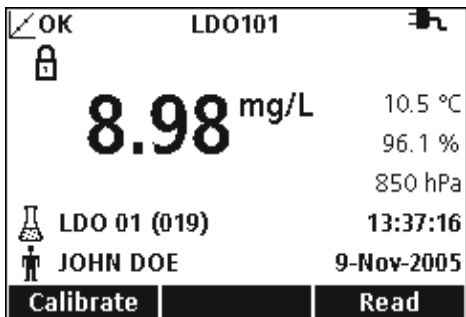
*Note: Be sure that no water is on the probe after placing it in the calibration chamber.*



4. When the reading is stable the standard value will be highlighted on the screen and the calibrated reading value will appear on the screen. Press the **UP** key under Done.

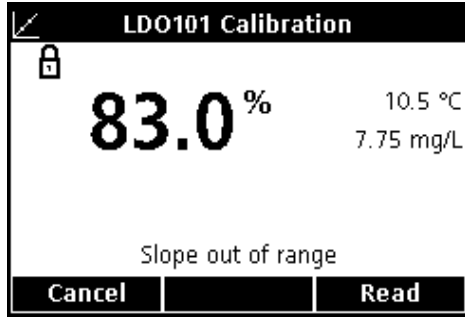


5. The Calibration Summary will appear. Press the **GREEN/RIGHT** key under Store to accept the calibration and return to the measurement mode. The calibration is recorded in the data log. If using the HQ40d meter, the calibration information is also sent to a PC/printer/flash memory stick if connected.



6. When the calibration is successful, the display will show OK in the upper left corner. A question mark will be displayed if the calibration has expired or if a check standard has failed or been delayed.

### 8.2.1 Calibration Error- Slope Out of Range



If the calibration slope does not meet the acceptance criteria, the display will show “Slope out of range”. If this happens, allow the probe to stand in the water-saturated air for several minutes to reach equilibrium and re-press the **GREEN/RIGHT** key under Read.

### 8.3 Setting LDO Methods



The LDO Method menu is available via the **METER OPTIONS/PARAMETER METHODS** key when Access Control is off, or when a valid password is entered. An LDO IntelliCAL probe must be connected to the meter to change these options.

[Table 5](#) outlines the software menu for LDO options. These options do not need to be changed if the default method is used. The Modify Current Method submenus and default settings are described in detail in [section 8.4 on page 82](#).

The HQ series meters contain a default method for LDO with settings for measurement, calibration, and units. The default settings cannot be changed. The default method must be saved and then modified. Use the **Save Current Method As** function to save the method as a new method that can be modified.

To enter options that are different from the default settings, a new method must be entered and then modified.

**Table 5 LDO Options Main Menu Summary**

LDO MAIN MENU	LDO SUBMENU
Current Method	Set Current Method
Save Current Method As	New Method Name
Modify Current Method	Measurement Options
	Select Units
	Calibration Standard
Delete a Method	Delete a Method

### 8.4 Modify Current Method Menu Summary

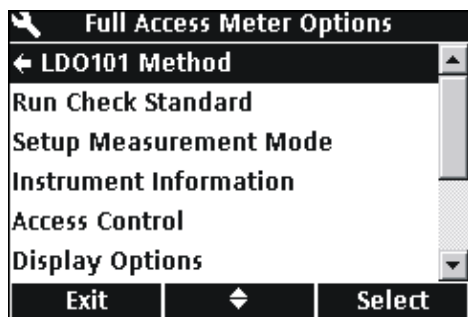
LDO METHOD OPTION	AVAILABLE SELECTIONS	DEFAULT SETTING
<b>Measurement Options</b>		
Resolution	0.1 Fast 0.01 Fast 0.01 Medium 0.01 Slow	0.01 Medium
Measurement Limits	Lower Limit: 0–20 mg/L Upper Limit: 0–20 mg/L	Lower: 0 mg/L Upper: 20 mg/L
Salinity Correction	0–70	0
Pressure Units	hPa mBar inHg mmHg	hPa
Averaging Interval	Off 30 s 60 s 90 s 3 min 5 min	Off
<b>Units</b>	mg/L %	mg/L
<b>Calibration<sup>1</sup></b>	User Factory	Factory
<b>Calibration Standard<sup>1</sup></b>	100% mg/L	100%
<b>Set Standard Value<sup>1</sup></b>	Enter Value	User-defined value

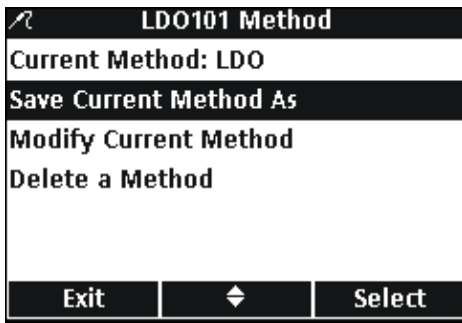
<sup>1</sup> For User Calibration Only

#### 8.4.1 Entering a New LDO Method

A new method for LDO can be entered when Access Control is off, or when a valid password is entered.

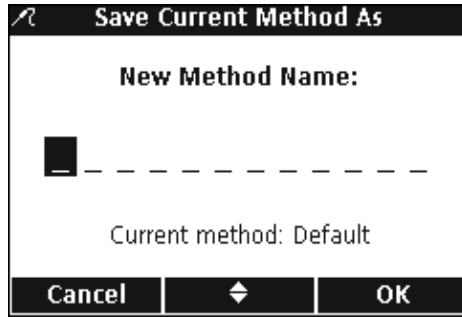
1. Press the **OPTIONS** key.
2. Use the **UP** and **DOWN** keys to highlight **LDO101 Method**. Press the **GREEN/RIGHT** key under Select.





- Use the **UP** and **DOWN** keys to highlight **Save Current Method As**. Press the **GREEN/RIGHT** key under Select.

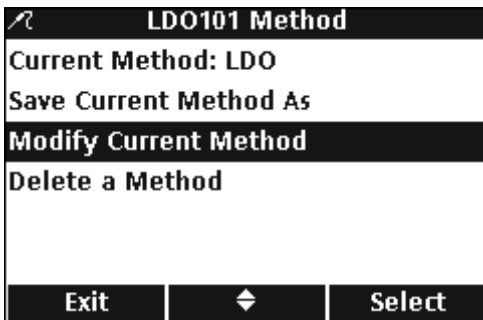
*Note: Modify Current Method and Delete a Method are not available until a new method is created.*



- Use the **UP** and **DOWN** keys to scroll through the letters and numbers. To select a letter or number, press the **GREEN/RIGHT** key. The cursor will advance to the next space.
- Repeat the previous step to add additional letters or numbers until the name is complete. To add a space, scroll to the blank space (between A and 9) using the **UP** and **DOWN** keys and press the **GREEN/RIGHT** key. To delete a letter or number, press the **BLUE/LEFT** key.
- Press the **GREEN/RIGHT** key until OK replaces the Right arrow in the function bar. Select **OK** to complete the entry.

### 8.4.2 Modifying an LDO Method

A method for LDO can be edited when Access Control is off, or when a valid password is entered.

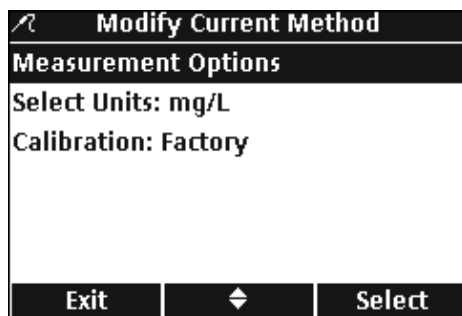


- From the LDO Method menu, use the **UP** and **DOWN** keys to highlight **Modify Current Method**. Press the **GREEN/RIGHT** key under Select.

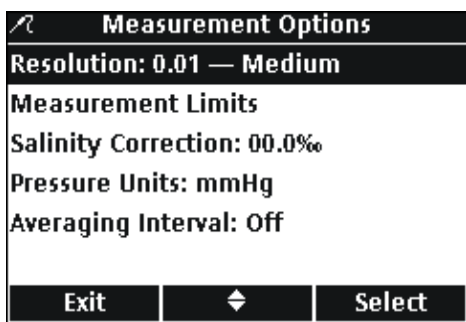
*Note: The default method cannot be modified or deleted, but can be saved with a new name (Save Current Method As) and then modified.*

### 8.4.3 Modifying LDO Measurement Options

Edit Measurement Options to change the displayed resolution, upper and lower limits, salinity correction, pressure units, or averaging interval.

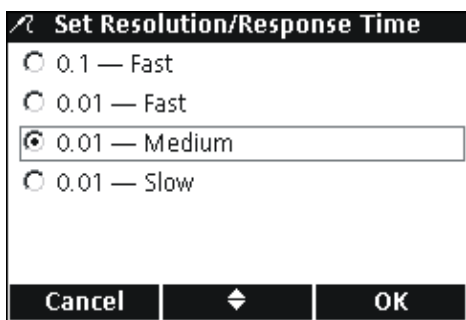


- With **Measurement Options** highlighted in the Modify Current Method menu, press the **GREEN/RIGHT** key under Select.

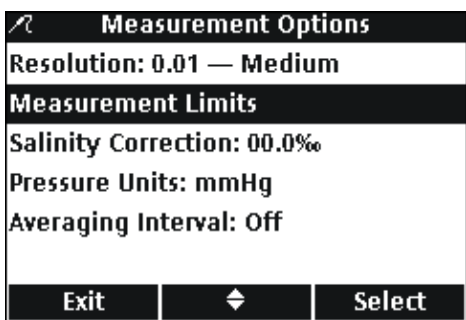


## Changing Resolution

1. With **Resolution** highlighted, press the **GREEN/RIGHT** key under Select.

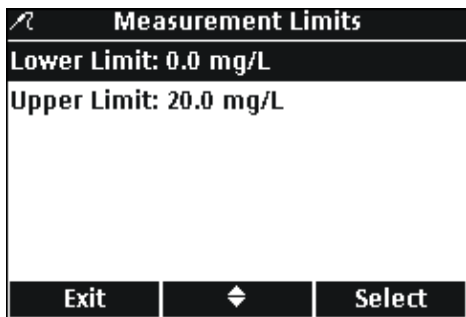


2. Use the **UP** and **DOWN** keys to select the desired resolution and speed of response. Press the **GREEN/RIGHT** key under OK.

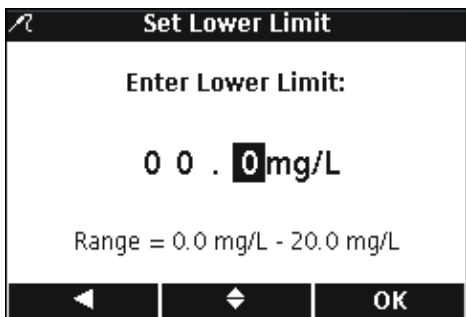


## Changing Measurement Limits

1. Use the **UP** and **DOWN** keys to select **Measurement Limits**. Press the **GREEN/RIGHT** key under Select.

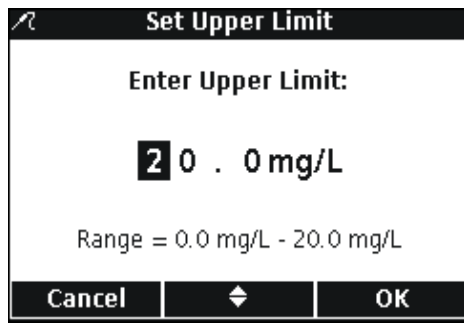


2. Use the **UP** and **DOWN** keys to select **Lower Limit** or **Upper Limit**. Press the **GREEN/RIGHT** key under Select.

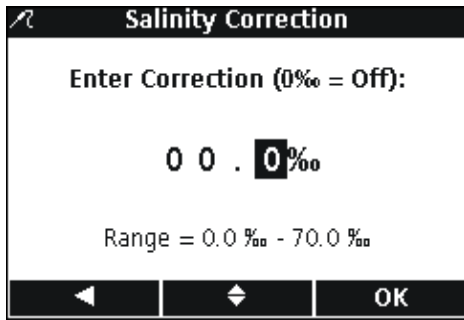


3. **Lower Limit:** Use the **UP** and **DOWN** keys to change the limit value. Use the **BLUE/LEFT** key to move to the left. Use the **GREEN/RIGHT** key to move to the right. When the cursor is at the far right, press the **GREEN/RIGHT** key under OK.





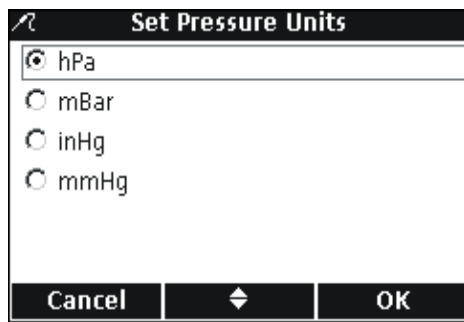
4. **Upper Limit:** Use the **UP** and **DOWN** keys to change the limit value. Use the **BLUE/LEFT** key to move to the left. Use the **GREEN/RIGHT** key to move to the right. When the cursor is at the far right, press the **GREEN/RIGHT** key under OK.



**Changing Salinity Correction**

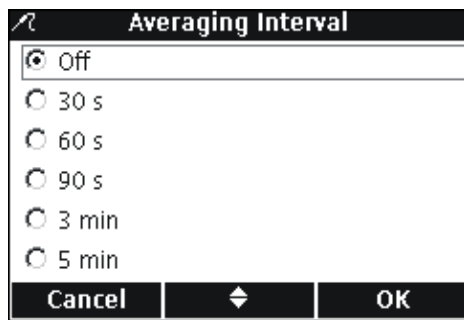
Correct dissolved oxygen values for high concentrations of dissolved salts by entering the sample salinity. Use a conductivity probe to measure the salinity.

1. Use the **UP** and **DOWN** keys to enter the sample salinity/salinity correction factor. Use the **BLUE/LEFT** key to move to the left. Use the **GREEN/RIGHT** key to move to the right. When the cursor is at the far right, press the **GREEN/RIGHT** key under OK.



**Changing Pressure Units**

1. Use the **UP** and **DOWN** keys to select the desired pressure units. Press the **GREEN/RIGHT** key under OK.



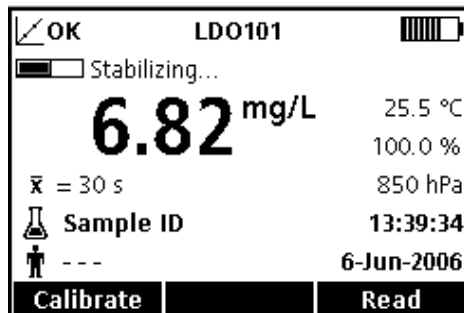
**Changing the Averaging Interval**

In samples containing a high amount of air bubbles such as aeration basins, results will appear unstable or noisy. Use the averaging function to improve stability.

To select the interval for averaging results:

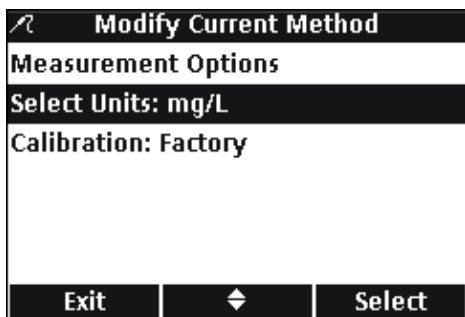
1. Use the **UP** and **DOWN** keys to select the desired Averaging Interval. Press the **GREEN/RIGHT** key under OK.

Displayed results will be averaged over the selected interval.



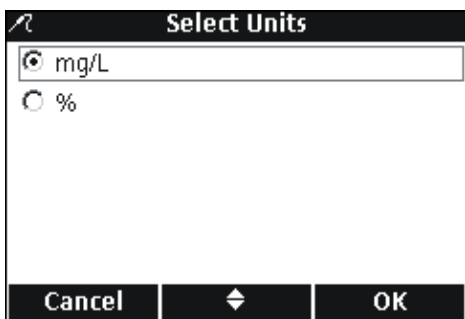
2. Whenever the average function is enabled, the averaging icon ( $\bar{x}$ ) will be displayed along with the averaging interval.

### 8.4.4 Modifying the LDO Measurement Units



The meter will display both mg/L DO and % saturation in the measurement mode. To change which unit is prominent:

1. Use the **UP** and **DOWN** keys to highlight **Select Units**. Press the **GREEN/RIGHT** key under Select.
2. Use the **UP** and **DOWN** keys to select the units. Press the **GREEN/RIGHT** key under OK.

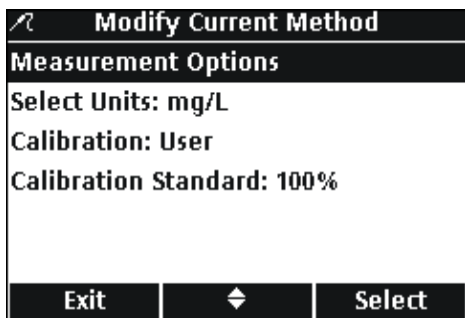


### 8.4.5 Modifying the LDO Calibration Standard

**Important Note:** Factory calibration is the default setting. Factory calibration coefficients are stored in the iButton.

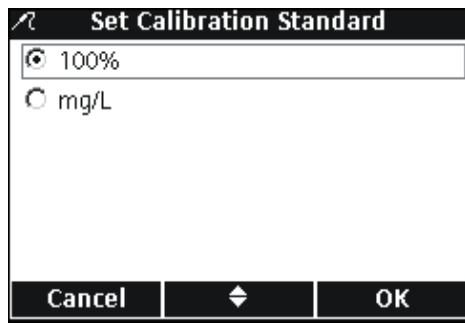
Each lot of LDO sensor caps is factory calibrated. Performance will vary slightly as a function of usage history. For best performance, a one-time calibration initialization can be performed when a new sensor is installed. Additional calibrations can be performed at the operator's discretion but are not required. See [section 8.2 on page 79](#) for calibration instructions.

#### 8.4.5.1 Selecting Water-Saturated Air as the Calibration Standard



To use water-saturated air as the calibration standard:

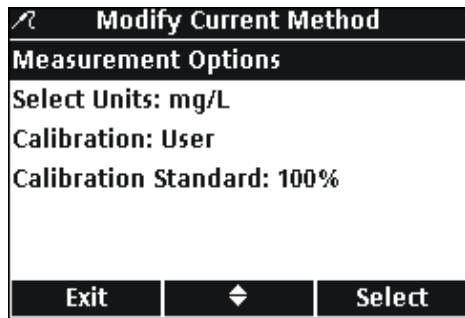
1. Use the **UP** and **DOWN** keys to highlight **Calibration Standard** in the Modify Current Method menu. Press the **GREEN/RIGHT** key under Select.



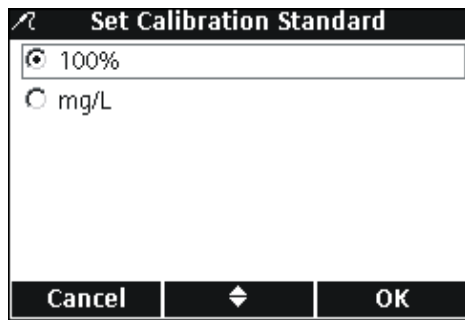
2. Use the **UP** and **DOWN** keys to select **100%**. Press the **GREEN/RIGHT** key under **OK**.

#### 8.4.5.2 Selecting a Water Sample as the Calibration Standard

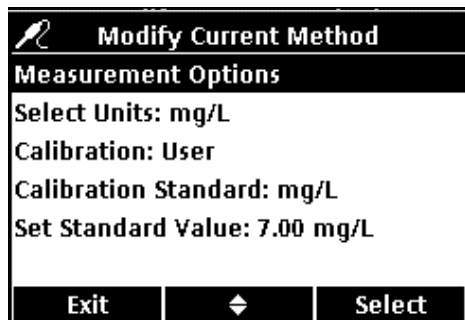
Water-saturated air is recommended for calibration of the HQ series meters, however a water sample with a known dissolved oxygen concentration can also be used. The dissolved oxygen concentration must be determined by Winkler titration, or by calculation of a saturated-air water sample using existing pressure, temperature, and salinity conditions.



1. Use the **UP** and **DOWN** keys to highlight **Calibration Standard** in the **Modify Current Method** menu. Press the **GREEN/RIGHT** key under **Select**.

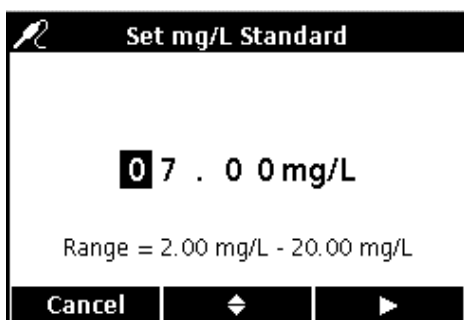


2. Use the **UP** and **DOWN** keys to select **mg/L**. Press the **GREEN/RIGHT** key under **OK**.



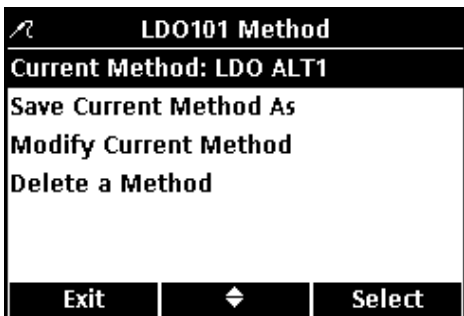
When using a water sample as the calibration standard, a default value of 7.00 mg/L is used. Change the standard value to the exact concentration determined for the sample as follows:

3. Use the **UP** and **DOWN** keys to select **Set Standard Value**. Press the **GREEN/RIGHT** key under **Select**.



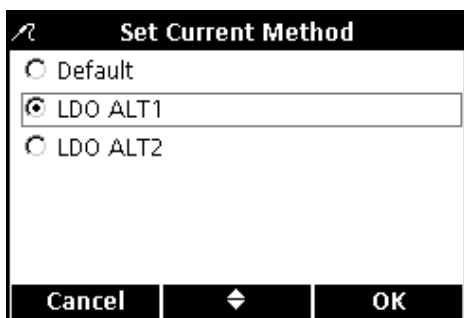
4. Use the **UP** and **DOWN** keys to change the standard value. Use the **BLUE/LEFT** key to move to the left. Use the **GREEN/RIGHT** key to move to the right. When the cursor is at the far right, press the **GREEN/RIGHT** key under OK.

### 8.4.6 Selecting a LDO Method



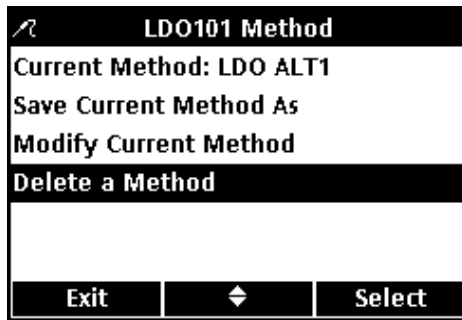
Select which method to use when additional methods have been entered in the LDO Options menu.

1. Use the **UP** and **DOWN** keys to highlight **Current Method**. Press the **GREEN/RIGHT** key under Select.



2. Use the **UP** and **DOWN** keys to select the desired method. Press the **GREEN/RIGHT** key under OK.

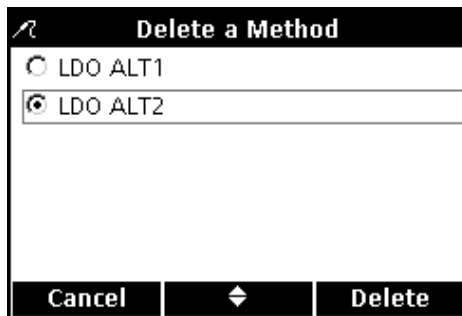
### 8.4.7 Deleting a Method



A screenshot of a terminal window titled "LDO101 Method". The menu options are: "Current Method: LDO ALT1", "Save Current Method As", "Modify Current Method", and "Delete a Method". The "Delete a Method" option is highlighted. At the bottom, there are three buttons: "Exit", a diamond-shaped cursor key, and "Select".

To delete an existing LDO method:

1. Use the **UP** and **DOWN** keys to highlight **Delete a Method**. Press the **GREEN/RIGHT** key under Select.
2. Use the **UP** and **DOWN** keys to select the desired method. Press the **GREEN/RIGHT** key under Delete. Once a method has been deleted, it cannot be recovered.



A screenshot of a terminal window titled "Delete a Method". It shows a list of methods: "LDO ALT1" and "LDO ALT2". The "LDO ALT2" option is selected with a radio button. At the bottom, there are three buttons: "Cancel", a diamond-shaped cursor key, and "Delete".



## Section 9 Advanced Operations



The various meter features that can be changed via the **OPTIONS** key is displayed in [section 9.1](#) and [section 9.2](#). The Parameter Method menu selection is a dynamic selection screen that can change depending on how many probes are attached to the meter. The Full Access Meter Options menu is displayed when Access Control is off, or when a valid password is entered. These options do not need to be changed if the default factory settings are used.

### 9.1 Meter Options Menu- Full Access

FULL ACCESS METER OPTIONS (Access Control Off or valid password entered)	
<b>RUN CHECK STANDARD</b>	Measure standard solution (available for pH and conductivity)
<b>SETUP MEASUREMENT MODE</b>	Press To Read
	Interval: Duration and Interval
	Continuous
<b>INSTRUMENT INFORMATION</b>	Probe Information
	Meter Information
<b>ACCESS CONTROL</b>	On or Off
	Set Access Password
<b>DISPLAY OPTIONS</b>	Contrast
	Auto-Shutoff
	Backlight
<b>SOUND</b>	Key Press
	Stability Alert
	Calibration Reminder
<b>TIME</b>	Set Time
	Time Format
	Set Date
	Date Format
<b>TEMPERATURE UNITS</b>	Set Temperature Units
<b>LANGUAGE</b>	Select Language

### 9.2 Operator Meter Options Menu

OPERATOR METER OPTIONS (Access Control On)	
<b>RUN CHECK STANDARD</b>	Measure standard solution (available for pH or conductivity)
<b>INSTRUMENT INFORMATION</b>	Probe Information
	Instrument Information
<b>ACCESS PASSWORD</b>	Enter Password
<b>DISPLAY OPTIONS</b>	Contrast
	Auto-Shutoff
	Backlight
<b>SOUND</b>	Key Press
	Stability Alert
	Calibration Reminder

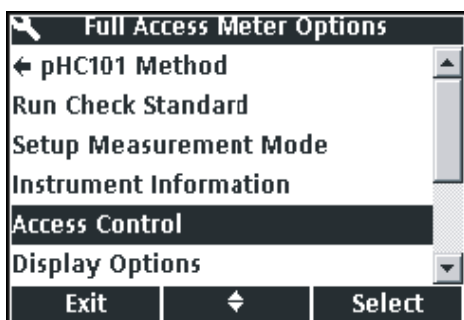
## 9.3 Using Access Control

Access Control is used to protect parameter methods and meter setup. When Access Control is on, options for Setup Measurement Mode, Access Control, Time, Temperature Units, and Language will be disabled in the Setup menu.

The Access Control option is available in the Meter Options>Full Access menu, which is available upon initial startup when Access Control is set to OFF, or when Access Control is set to ON and a valid password is entered.

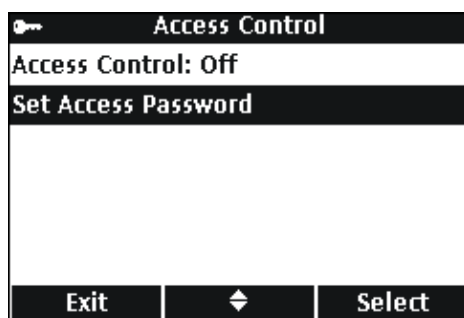
**Important Note:** Set the password before turning Access Control on. If a password is specified and Access Control is set to ON, make sure the password is stored in a safe place. If the password is forgotten, the operator will be locked out of the meter.

### 9.3.1 Turning Access Control On

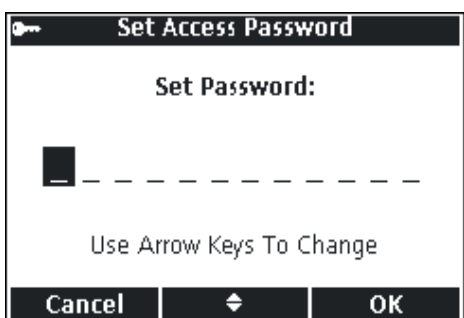


To protect parameter methods and meter setup:

1. Press the **METER OPTIONS** key.
2. Use the **UP** and **DOWN** keys to highlight **Access Control**. Press the **GREEN/RIGHT** key under Select.

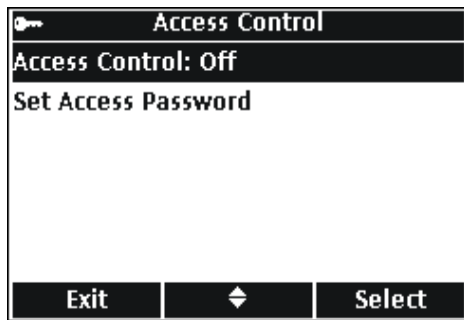


3. Use the **UP** and **DOWN** keys to highlight **Set Access Password**. Press the **GREEN/RIGHT** key under Select.

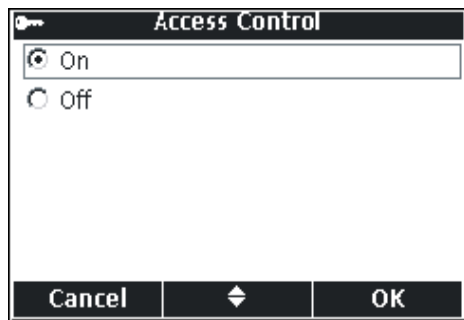


4. Use the **UP** and **DOWN** keys to scroll through the letters and numbers. To accept a letter or number, press the **GREEN/RIGHT** key. The cursor will advance to the next space.
5. Repeat the previous step to add additional letters or numbers until the password is complete. To add a space, scroll to the blank space between A and 9 using the **UP** and **DOWN** keys and press the **GREEN/RIGHT** key. To replace a letter or number, press the **BLUE/LEFT** key and re-enter the letter or number.
6. Press the **GREEN/RIGHT** key until OK replaces the right arrow in the function bar. Select OK to complete the entry.





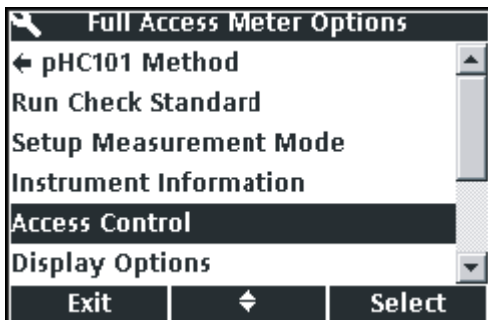
- Use the **UP** and **DOWN** keys to highlight **Access Control**. Press the **GREEN/RIGHT** key under **Select**.



- Use the **UP** and **DOWN** keys to select **ON**. Press the **GREEN/RIGHT** key under **Select**.

Access is now restricted. The Operator Meter Options menu will be displayed when the **OPTIONS** key is pressed.

### 9.3.2 Turning Access Control Off



To turn Access Control off:

- Press the **OPTIONS** key.
- Use the **UP** and **DOWN** keys to highlight **Access Control**. Press the **GREEN/RIGHT** key under **Select**. Select **Off** to turn Access Control off.

## 9.4 Running Check Standards

Run Check Standards verifies equipment accuracy by measuring a solution of known conductivity or pH. When the IntelliCAL probe is placed in the solution, the meter will indicate if the Check Standard passed or failed.

The meter can automatically display a reminder to measure a check standard at a specified interval with a specified acceptance criteria. These options are changed in the Parameter Method menu for each parameter.

## 9.5 Setting the Measurement Mode

Three measurement modes affect the way measurements are taken and data is stored:

### PRESS TO READ:

The **GREEN/RIGHT** key must be pressed for each sample measurement. Each result is stored in the Data Log automatically when the Set Stability Criteria are met. The result is also sent simultaneously to any device (PC/printer/flash memory stick) that is connected to the USB/DC power adaptor.

### INTERVAL:

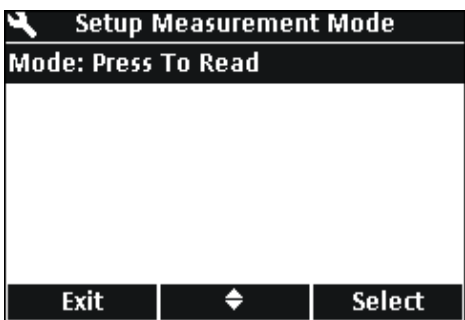
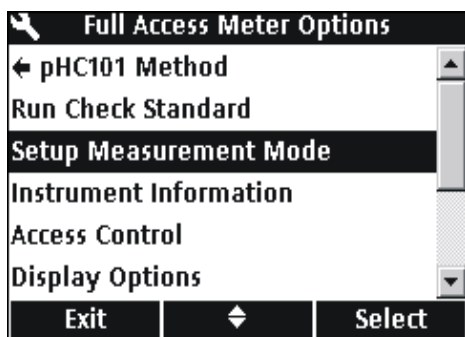
The meter measures the sample at a user defined interval for a user defined duration and stores the data in the Data Log automatically. The result is also sent simultaneously to any device (PC/printer/flash memory stick) that is connected to the USB/DC power adaptor.

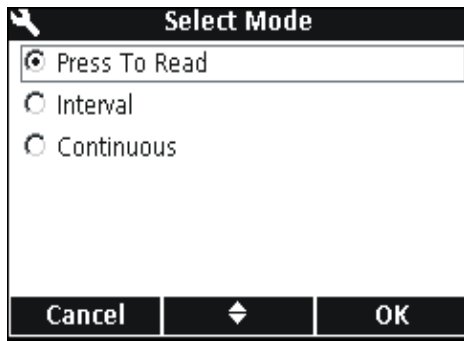
### CONTINUOUS:

The meter continuously measures the sample, and data can be stored manually in the Data Log. When stored, the data point is also sent simultaneously to any device (PC/printer/flash stick) that is connected to the USB/DC power adaptor.

To select a measurement mode:

1. Press the **OPTIONS** key.
2. Use the **UP** and **DOWN** keys to highlight **Setup Measurement Mode**. Press the **GREEN/RIGHT** key under Select.
3. With **Mode** highlighted, press the **GREEN/RIGHT** key under Select.



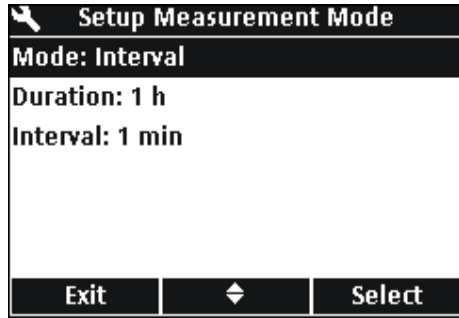


4. Use the **UP** and **DOWN** keys to select **Press to Read**, **Interval**, or **Continuous**. Press the **GREEN/RIGHT** key under OK.

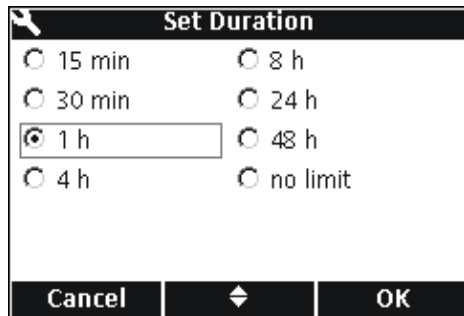
### 9.5.1 Setting Auto Measurement Intervals

When using the Interval Mode, it must be specified how often and for how long the measurements will be taken. Calibration Reminders, Auto Shut Off, and Check Standard Reminders do not interrupt interval measurements. However, a missed calibration will store readings as Cal? rather than as Cal OK. After interval measurements are completed, any missed reminders appear and Auto Shut Off is enabled.

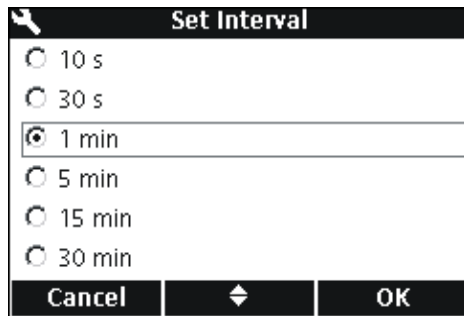
To specify the measurement interval and duration:



1. Select Interval as the Measurement Mode.
2. Use the **UP** and **DOWN** keys to select **Duration**. Press the **GREEN/RIGHT** key under Select to display the Set Duration screen.

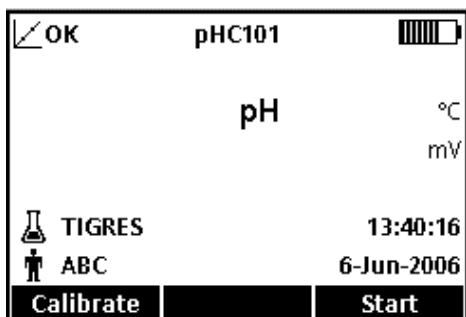


3. Use the **UP** and **DOWN** keys to select the duration or total time that measurements will be taken. Press the **GREEN/RIGHT** key under OK.



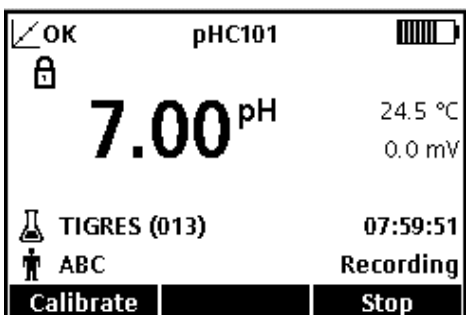
4. Use the **UP** and **DOWN** keys to select **Interval**. Press the **GREEN/RIGHT** key under Select to display the Set Interval screen.
5. Use the **UP** and **DOWN** keys to select how often measurements will be taken. Press the **GREEN/RIGHT** key under OK.

### 9.5.2 Starting Interval Measurements



From the Main Measurement screen, press the **GREEN/RIGHT** key under Start to begin interval measurements. The remaining duration for the measurement is displayed in the lower right corner of the screen. The Sample ID automatically advances by number for each reading.

The auto-shutoff feature is disabled during interval measurements. The meter goes into a standby state between readings to conserve power. Measurements are suspended when performing calibration, running check standards, or using the Meter Options menu. Measurements resume when returning to the reading mode.



Measurements stop when the selected interval duration has passed. The auto-shutoff feature becomes active. To repeat the interval measurement, press the **GREEN/RIGHT** key under Start.

### 9.5.3 Preventing Data Log Overflow in Interval Reading Mode

When measurements are taken at specified intervals, each result will be stored automatically in the Data Log. The meter can store up to 500 data records. If the number of accumulated results exceeds 500, data will be replaced on a first in first out basis (FIFO). Meters can be connected to a PC/printer/flash memory stick to prevent loss of data.

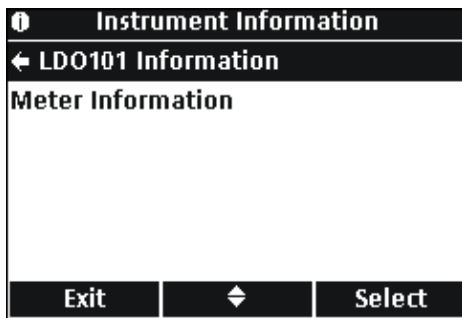
**Table 6 Suggested Combinations of Interval/Duration to Prevent Data Log Overflow**

Interval	Duration
10 seconds	1 hour
30 seconds	4 hours
1 minute	8 hours
5 minutes	24 hours

**Note:** Stop interval measurements before making any method or meter setup changes.

## 9.6 Viewing Instrument Information

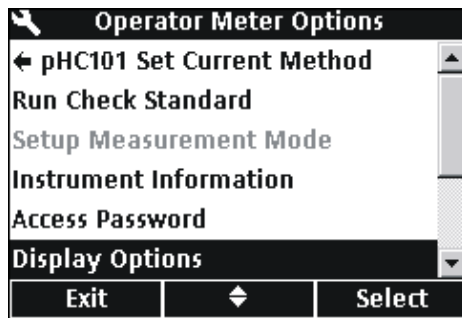
Use the Instrument Information menu to find the serial number, software version, and model number of the meter or IntelliCAL probes connected to the meter.



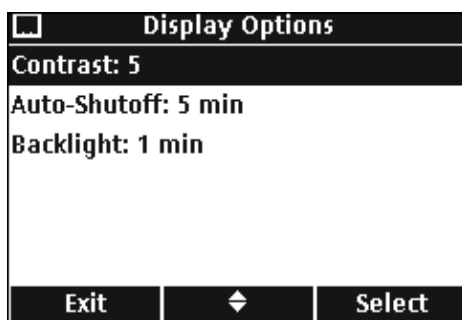
1. Press the **OPTIONS** key.
2. Use the **UP** and **DOWN** keys to highlight **Instrument Information**. Press the **GREEN/RIGHT** key under Select.
3. Use the **UP** and **DOWN** keys to choose probe information or meter information. Press the **GREEN/RIGHT** key under Select.

## 9.7 Setting the Display Options

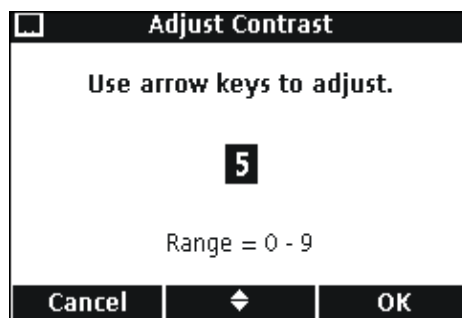
Use Display Options to change the display contrast, battery saving auto-shutoff options, and the backlight option.



1. Press the **METER OPTIONS** key. Use the **UP** and **DOWN** keys to highlight **Display Options**. Press the **GREEN/RIGHT** key under Select.

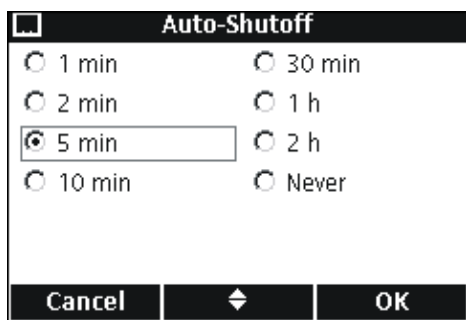


2. Use the **UP** and **DOWN** keys to choose **Contrast**, **Auto-Shutoff**, or **Backlight**. Press the **GREEN/RIGHT** key under Select.



### CONTRAST

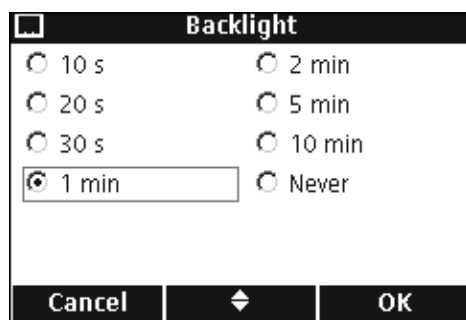
Use the **UP** and **DOWN** keys to adjust the contrast of the display. Zero is the lightest setting and 9 is the darkest setting. Press the **GREEN/RIGHT** key under OK to accept the setting.



### AUTO-SHUTOFF

Auto-shutoff maximizes battery life and is not active when the meter is connected to AC power or in Interval Reading Mode.

Use the **UP** and **DOWN** keys to select a time period after which the meter will shut off if no keys are pressed. Press the **GREEN/RIGHT** key under OK.



### BACKLIGHT

The display is illuminated when the **BACKLIGHT** key is pressed. To maximize battery life, set a time period after which the backlight will automatically turn off if no key is pressed.

Use the **UP** and **DOWN** keys to select a time period after which the backlight will shut off if no keys are pressed. Press the **GREEN/RIGHT** key under OK.

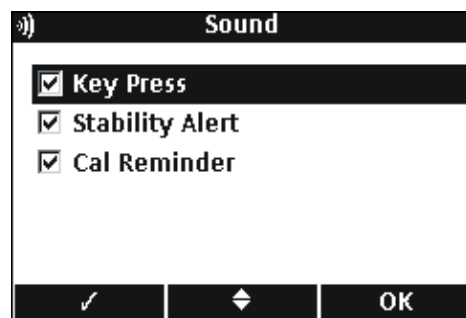
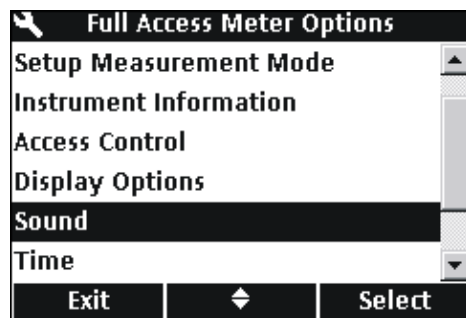
## 9.8 Setting the Sound Options

The meter can make an audible sound when a key is pressed, when stability is reached, or when the calibration reminder is due. The meter can also make an audible sound when it begins transferring data to a flash memory stick and again when the data transfer is complete.

To turn the sound on or off:

1. Press the **METER OPTIONS** key.
2. Use the **UP** and **DOWN** keys to highlight **Sound**. Press the **GREEN/RIGHT** key under Select.
3. Use the **UP** and **DOWN** keys to highlight **Key Press**, **Stability Alert**, or **Cal Reminder**. Press the **BLUE/LEFT** key under the check mark. Multiple items can be selected.

**Note:** Select **Stability Alert** to turn on sound for data transfer to a flash memory stick.

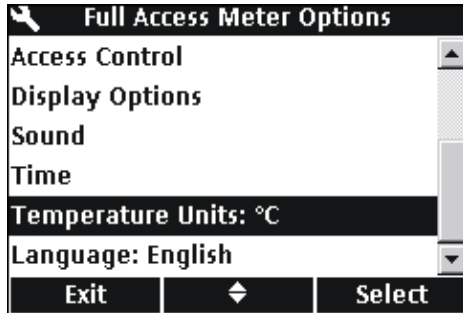


## 9.9 Setting the Date and Time

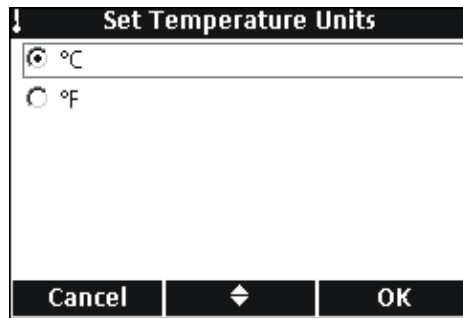
Refer to [section 4.4 on page 22](#) for more information.

## 9.10 Changing the Temperature Units

To select degrees Celsius or Fahrenheit:



1. Press the **METER OPTIONS** key.
2. Use the **UP** and **DOWN** keys to highlight **Temperature Units**. Press the **GREEN/RIGHT** key under Select.



3. Use the **UP** and **DOWN** keys to select Celsius or Fahrenheit. Press the **GREEN/RIGHT** key under OK.

## 9.11 Language

Refer to [section 4.3 on page 22](#) for more information.





# Section 10 Maintenance

---

**DANGER**

**Only qualified personnel should conduct the tasks described in this section of the manual.**

## 10.1 General Meter Cleaning

The meter is designed to be maintenance-free. If the meter is dirty, wipe the surface with a damp cloth. Use a cotton-tipped applicator to clean or dry the connectors if they get wet.

## 10.2 General Probe Cleaning

For information about cleaning the probes, see the instruction sheet that comes with the IntelliCAL probe.

## 10.3 Battery Replacement

See [section 3.2 on page 12](#).

## 10.4 Updating Instrument Software

From time to time Hach Company may release updates to the meter software. A flash stick connected to the USB/DC power adapter can be used to update the instrument software or transfer data from the instrument.

**Note:** *The manufacturer will determine if an update to the software is necessary to make sure that the HQd Series correctly functions.*



# Section 11 Parts and Accessories

## 11.1 Parts

Description	Quantity	Catalog Number
LDO Probe, standard, with 1 m cable	1	LDO101-01
LDO Probe, standard, with 3 m cable	1	LDO101-03
LDO Probe, rugged, with 5 m cable	1	LDO101-05
LDO Probe, rugged, with 10 m cable	1	LDO101-10
LDO Probe, rugged, with 15 m cable	1	LDO101-15
LDO Probe, rugged, with 30 m cable	1	LDO101-30
pH Gel Probe, standard, with 1m cable	1	PHC101-01
pH Gel Probe, standard, with 3m cable	1	PHC101-03
pH Liquid Probe, standard, with 1m cable	1	PHC301-01
pH Liquid Probe, standard, with 3m cable	1	PHC301-03
pH Gel Probe, rugged, with 5m cable	1	PHC101-05
pH Gel Probe, rugged, with 10m cable	1	PHC101-10
pH Gel Probe, rugged, with 15m cable	1	PHC101-15
pH Gel Probe, rugged, with 30m cable	1	PHC101-30
Conductivity Probe, standard with 1m cable	1	CDC401-01
Conductivity Probe, standard with 3m cable	1	CDC401-03
Conductivity Probe, rugged with 5m cable	1	CDC401-05
Conductivity Probe, rugged with 10m cable	1	CDC401-10
Conductivity Probe, rugged with 15m cable	1	CDC401-15
Conductivity Probe, rugged with 30m cable	1	CDC401-30

## 11.2 Accessories

Description	Quantity	Catalog Number
Probe Depth Marker (Rugged Cable Markers)	5	58286-10
LDO Sensor Cap, Replacement (includes iButton, cap seal, and probe-tip o-ring)	1	58112-00
Glove Kit	1	58287-00
Field Kit	1	52258-00
Standard Probe Holder	1	58294-00
Rugged Shroud Kit	1	58259-00
Color Coded Probe Clips (five colors, two clips in each color)	1	58184-00
AC Power Adapter Kit, 115 VAC	1	58263-00
AC Power Adapter Kit, 230 VAC	1	58311-00
Batteries, Alkaline AA	4/pkg	19380-04
USB/DC Power Adapter	1	58134-00
USB Cable, 6 ft. (1.8 m), Type A Male, Type B Male	1	59240-00
Keyboard (QWERTY)	1	LZV582
BOD Bottle (300 mL)	1	621-00
BOD Stirrer/Funnel Accessory Kit (US)	1	58266-00
BOD Stirrer/Funnel Accessory Kit (EU)	1	58267-00
Software for direct connection to PC	1	HQ40d45

## 11.3 Consumables

Description	Quantity	Catalog Number
<b>IUPAC Series Certified pH Standards (Buffers)<sup>1</sup>:</b>		
pH 1.679 ± 0.010 @ 25 °C	500 mL	S11M001
pH 4.005 ± 0.010 @ 25 °C	500 mL	S11M002
pH 7.000 (Radiometer Analytical) ± 0.010 @ 25 °C	500 mL	S11M004
pH 10.012 ± 0.010 @ 25 °C	500 mL	S11M007
pH 12.45 ± 0.05 @ 25 °C	500 mL	S11M008
<b>Color-coded pH Standards (Buffers):</b>		
pH 4.01 ± 0.02 @ 25 °C	500 mL	22834-49
pH 7.00 ± 0.02 @ 25 °C	500 mL	22835-49
pH 10.01 ± 0.02 @ 25 °C	500 mL	22836-49
pH 4.01 ± 0.02 @ 25 °C	4 L	22834-56
pH 7.00 ± 0.02 @ 25 °C	4 L	22835-56
pH 10.01 ± 0.02 @ 25 °C	4 L	22836-56
pH 4.01 ± 0.02 @ 25 °C	20 L	22834-61
pH 7.00 ± 0.02 @ 25 °C	20 L	22835-61
pH 10.01 ± 0.02 @ 25 °C	20 L	22836-61
<b>Certified Conductivity Standards<sup>1</sup>:</b>		
KCl, 1 Demal, 111.3 mS/cm ± 0.5% @ 25 °C	500 mL	S51M001
KCl, 0.1 Demal, 12.85 mS/cm ± 0.35% @ 25 °C	500 mL	S51M002
KCl, 0.01 Demal, 1408 µS/cm ± 0.5% @ 25 °C	500 mL	S51M003
NaCl, 0.05%, 1015 µS/cm ± 0.5% @ 25 °C	500 mL	S51M004
<b>KCl Conductivity Standards:</b>		
0.1 Molar KCl, 12.88 mS/cm @ 25 °C	500 mL	C20C250
0.01 Molar KCl, 1413 µS/cm @ 25 °C	500 mL	C20C270
0.001 Molar KCl, 148 µS/cm @ 25 °C	500 mL	C20C280
<b>NaCl Conductivity Standards:</b>		
180 µS/cm @ 25 °C	100 mL	23075-42
1000 µS/cm @ 25 °C	100 mL	14400-42
18.00 mS/cm @ 25 °C	100 mL	23074-42
<b>BOD Consumables:</b>		
Nitrification Inhibitor (TCMP) - (200 tests)	35 g	2533-35
Nitrification inhibitor (TCMP) - (2500 tests)	500 g	2533-34
Nitrification Inhibitor (ATU)	50 g	28454-25
BOD Seed (50 tests)	50 capsules	24712-00
BOD Standard Solution, 300 mg/L GGA, 10-mL Voluette® Ampules	25/pkg	14865-10
Nutrient Buffer Pillow, 0.5 mL (for preparing 300 mL of dilution water)	50/pkg	14160-66
Nutrient Buffer Pillow, 3 mL (for preparing 3 L of dilution water)	50/pkg	14861-66
Nutrient Buffer Pillow, 4 mL (for preparing 4 L of dilution water)	50/pkg	24364-66
Nutrient Buffer Pillow, 6 mL (for preparing 6 L of dilution water)	50/pkg	14862-66
Nutrient Buffer Pillow, 19 mL (for preparing 19 L of dilution water)	25/pkg	14863-98
Buffer Solution, APHA, for BOD, pH 7.2, phosphate type	1 L	431-53
Calcium Chloride Solution, APHA	1 L	428-53

### 11.3 Consumables (continued)

Description	Quantity	Catalog Number
Magnesium Sulfate Solution, APHA	1 L	430-53
Ferric Chloride Solution, APHA	1 L	429-53
<b>Miscellaneous:</b>		
pH Filling Solution (for PHC301), 3M KCl, saturated with AgCl	30 mL	28417-00
pH Electrode Storage Solution	500 mL	27565-49

<sup>1</sup> Certified standards ship with certificates for traceability to Standard Reference Materials



## Section 12 How to Order

---

### U.S.A. Customers

**By Telephone:**

6:30 a.m. to 5:00 p.m. MST  
Monday through Friday  
(800) 227-HACH (800-227-4224)

**By Fax:**

(970) 669-2932

**By Mail:**

Hach Company  
P.O. Box 389  
Loveland, Colorado 80539-0389 U.S.A.

**By E-mail:**

orders@hach.com

### Information Required

- Hach account number (if available)
- Your name and phone number
- Purchase order number
- Brief description or model number
- Billing address
- Shipping address
- Catalog number
- Quantity

### International Customers

Hach maintains a worldwide network of dealers and distributors. To locate the representative nearest you, send an e-mail to: intl@hach.com or contact:

**Hach Company World Headquarters;** Loveland, Colorado, U.S.A.  
Telephone: (970) 669-3050; Fax: (970) 669-2932

### Technical and Customer Service (U.S.A. only)

Hach Technical and Customer Service Department personnel are eager to answer questions about our products and their use. Specialists in analytical methods, they are happy to put their talents to work for you.

Call 1-800-227-4224 or e-mail techhelp@hach.com





## Section 13 Repair Service

---

**Authorization must be obtained from Hach Company before sending any items for repair. Please contact the Hach Service Center serving your location.**

**In the United States:**

Hach Company  
Ames Service  
100 Dayton Avenue  
Ames, Iowa 50010  
(800) 227-4224 (U.S.A. only)  
FAX: (515) 232-3835

**In Canada:**

Hach Sales & Service Canada Ltd.  
1313 Border Street, Unit 34  
Winnipeg, Manitoba  
R3H 0X4  
(800) 665-7635 (Canada only)  
Telephone: (204) 632-5598  
FAX: (204) 694-5134  
E-mail: [canada@hach.com](mailto:canada@hach.com)

**In Latin America, the Caribbean, the Far East,  
Indian Subcontinent, Africa, Europe, or the Middle East:**

Hach Company World Headquarters,  
P.O. Box 389  
Loveland, Colorado, 80539-0389 U.S.A.  
Telephone: (970) 669-3050  
FAX: (970) 669-2932  
E-mail: [intl@hach.com](mailto:intl@hach.com)



## Section 14 Certification

---

Hach Company certifies this instrument was tested thoroughly, inspected and found to meet its published specifications when it was shipped from the factory.

The HQ Series Portable Meters have been tested and are certified as indicated to the following instrumentation standards:

### Product Safety (power supply only)

115/230 VAC External Power Supply

Certified to CSA and Listed to UL safety standards (cULus mark), TUV-GS & CE marked per 73/23/EEC

### EMI Immunity

Instrument tested with the external Power Supply:

Per 89/336/EEC EMC: EN 61326:1998 (Electrical Equipment for measurement, control and laboratory use— EMC requirements) Supporting test records by Hach Company, certified compliance by Hach Company.

#### **Standards include:**

IEC 1000-4-2:1995 (EN 61000-4-2:1995) Electro-Static Discharge Immunity (Criteria B)

IEC 1000-4-3:1995 (EN 61000-4-3:1996) Radiated RF Electro-Magnetic Field Immunity (Criteria B)

IEC 1000-4-4:1995 (EN 61000-4-5:1995) Electrical Fast Transients/Burst (Criteria B)

IEC 1000-4-5:1995 (EN 61000-4-5:1995) Surge (Criteria B)

IEC 1000-4-6:1996 (EN 61000-4-6:1996) Conducted Disturbances Induced by RF Fields (Criteria A)

IEC 1000-4-11:1994 (EN 61000-4-11:1994) Voltage Dip/Short Interruptions (Criteria B)

Additional immunity Standard/s include:

ENV 50204:1996 Radiated Electro-Magnetic Field from Digital Telephones (Criteria B)

### Emissions

Instrument tested with the external Power Supply:

Per 89/336/EEC EMC: EN 61326:1998 (Electrical Equipment for measurement, control and laboratory use—EMC requirements) Class "B" emission limits all models except HQ40D Multi-Portable Meter with "2" LDO probes. The HQ40D when used with "2" LDO probes meets only Class "A" limits. Supporting test records by Hewlett Packard, Fort Collins, Colorado Hardware Test Center (A2LA # 0905-01) and certified compliance by Hach Company.

#### **Standards include:**

EN 61000-3-2 Harmonic Disturbances Caused by Electrical Equipment

EN 61000-3-3 Voltage Fluctuation (Flicker) Disturbances Caused by Electrical Equipment

## Additional Emissions Standard/s include

EN 55011 (CISPR 11), Class “B” emission limits all models except HQ40D Multi-Portable Meter with “2” LDO probes. The HQ40D when used with “2” LDO probes meets only Class “A” limits.

## CANADIAN INTERFERENCE-CAUSING EQUIPMENT REGULATION

IECS-003: Class “A” emission limits. Supporting test records by Hewlett Packard, Fort Collins, Colorado Hardware Test Center (A2LA # 0905-01) and certified compliance by Hach Company.

This Class “A” digital apparatus meets all requirements of the Canadian Interference- Causing Equipment Regulations.

Cet appareil numérique de la classe “A” respecte toutes les exigences du Règlement sur le matériel brouilleur du Canada.

## FCC PART 15: Class emission A limits

Supporting test records by Hewlett Packard, Fort Collins, Colorado Hardware Test Center (A2LA # 0905-01) and certified compliance by Hach Company.

This device complies with Part 15 of the FCC Rules. Operation is subject to the following two conditions:

(1) this device may not cause harmful interference, and (2) this device must accept any interference received, including interference that may cause undesired operation.

Changes or modifications to this unit not expressly approved by the party responsible for compliance could void the user’s authority to operate the equipment.

This equipment has been tested and found to comply with the limits for a Class “A” digital device, pursuant to Part 15 of the FCC Rules. These limits are designed to provide reasonable protection against harmful interference when the equipment is operated in a commercial environment. This equipment generates, uses, and can radiate radio frequency energy and, if not installed and used in accordance with the instruction manual, may cause harmful interference to radio communications. Operation of this equipment in a residential area is likely to cause harmful interference, in which case the user will be required to correct the interference at their own expense. The following techniques of reducing the interference problems are applied easily.

1. Disconnect the external power supply from the meter and/or remove one of the meter’s batteries to verify that meter is or is not the source of the interference.
2. Move the meter and it’s power supply away from the device receiving the interference.
3. Reposition the receiving antenna for the device receiving the interference.
4. Try combinations of the above.

## Section 15 Limited Warranty

---

Hach Company warrants its products to the original purchaser against any defects that are due to faulty material or workmanship for a period of one year from date of shipment unless otherwise noted in the product manual.

In the event that a defect is discovered during the warranty period, Hach Company agrees that, at its option, it will repair or replace the defective product or refund the purchase price excluding original shipping and handling charges. Any product repaired or replaced under this warranty will be warranted only for the remainder of the original product warranty period.

This warranty does not apply to consumable products such as chemical reagents; or consumable components of a product, such as, but not limited to, lamps and tubing.

Contact Hach Company or your distributor to initiate warranty support. Products may not be returned without authorization from Hach Company.

### Limitations

This warranty does not cover:

- Damage caused by acts of God, natural disaster, labor unrest, acts of war (declared or undeclared), terrorism, civil strife or acts of any governmental jurisdiction
- Damage caused by misuse, neglect, accident or improper application or installation
- Damage caused by any repair or attempted repair not authorized by Hach Company
- Any product not used in accordance with the instructions furnished by Hach Company
- Freight charges to return merchandise to Hach Company
- Freight charges on expedited or express shipment of warranted parts or product
- Travel fees associated with on-site warranty repair

This warranty contains the sole express warranty made by Hach Company in connection with its products. All implied warranties, including without limitation, the warranties of merchantability and fitness for a particular purpose, are expressly disclaimed.

Some states within the United States do not allow the disclaimer of implied warranties and if this is true in your state the above limitation may not apply to you. This warranty gives you specific rights, and you may also have other rights that vary from state to state.

This warranty constitutes the final, complete, and exclusive statement of warranty terms and no person is authorized to make any other warranties or representations on behalf of Hach Company.

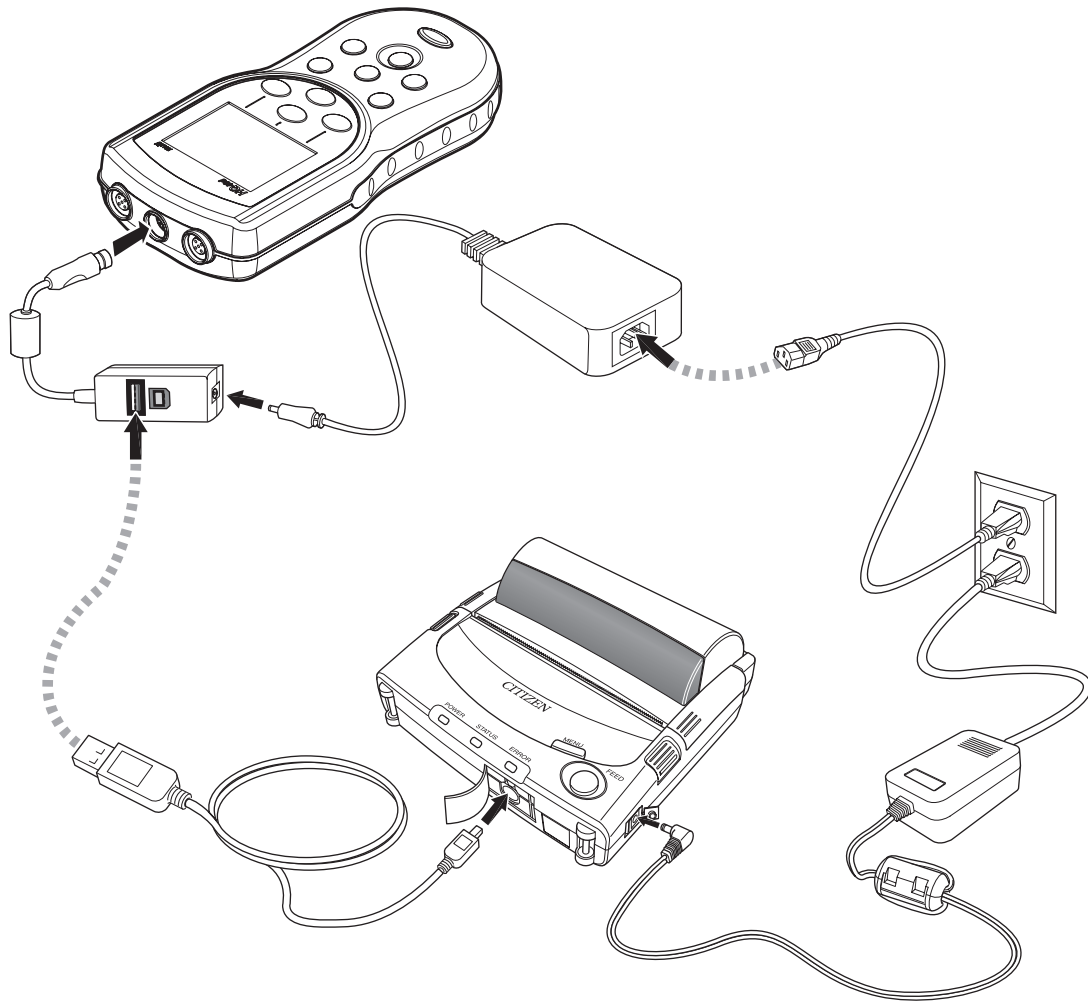
### Limitation of Remedies

The remedies of repair, replacement or refund of purchase price as stated above are the exclusive remedies for the breach of this warranty. On the basis of strict liability or under any other legal theory, in no event shall Hach Company be liable for any incidental or consequential damages of any kind for breach of warranty or negligence.



# Appendix A Connecting the Citizen Handy Printer PD-24

---



**WARNING**  
*Refer to the manual provided with the printer for detailed safety information.*





- 
- A**
- AC power supply ..... 12
  - Access Control
    - passwords ..... 92
    - turning off ..... 93
    - turning on ..... 92
  - accessories ..... 103
  - auto-shutoff, batteries ..... 14, 98
  - averaging interval, LDO methods ..... 85
- B**
- Backlight options ..... 98
  - batteries
    - auto-shutoff ..... 14, 98
    - features ..... 8
    - installing ..... 12
  - beep options ..... 98
  - box contents ..... 11
- C**
- cables, part numbers ..... 103
  - calibrating probes
    - conductivity ..... 63
    - LDO ..... 79
    - pH ..... 47
    - Slope out of range error ..... 48, 81
    - Standard not recognized error ..... 48
  - Calibration ..... 41
  - Calibration Log
    - displaying ..... 29
  - calibration options
    - conductivity ..... 67, 72
    - LDO ..... 86
    - pH ..... 55
  - calibration reports
    - viewing ..... 40
  - Canadian safety regulations ..... 112
  - Celsius, settings ..... 99
  - certification ..... 111
  - Check Standards
    - conductivity method options ..... 67, 75
    - deferring (conductivity) ..... 66
    - deferring (pH) ..... 51
    - log, displaying ..... 29
    - pH method options ..... 59
    - running manually or automatically (conductivity) ..... 65
    - running manually or automatically (pH) ..... 49
    - settings ..... 93
  - cleaning ..... 101
  - column headers ..... 32
  - components, unpacking ..... 11
  - computers, transferring data to ..... 16
  - conductivity
    - calibrating probe ..... 63
    - deferring Check Standards ..... 66
    - measuring ..... 64
    - probe specifications ..... 9
    - running Check Standards ..... 65
  - conductivity methods
    - calibration options ..... 67, 72
    - Check Standards options ..... 67, 75
    - limits ..... 69
    - measurement options ..... 67, 69
    - menu options ..... 66
    - modifying ..... 68
    - parameters ..... 67
    - parameters, changing ..... 68
    - reference temperature ..... 71
    - temperature correction ..... 70
    - units ..... 69
  - connectors, probe ..... 14
  - contact information
    - ordering parts ..... 107
    - repair service ..... 109
    - support ..... 107
  - Continuous measurement mode ..... 94
  - contrast, display ..... 97
  - Current ..... 40
  - customer support ..... 107
- D**
- data
    - deleting ..... 30
    - overflow, preventing ..... 96
    - viewing downloaded data files ..... 42
    - viewing probe ..... 29
    - viewing stored ..... 28
  - data transfer
    - archiving and exchanging methods ..... 45
    - calibration data from probe ..... 35
    - computer ..... 34
    - features ..... 16
    - flash memory stick ..... 33
    - formatting ..... 31
  - date, setting ..... 22
  - deferring Check Standards
    - conductivity ..... 66
    - pH ..... 51
  - deleting
    - methods ..... 89
    - Operator ID ..... 28
    - Sample IDs ..... 26
    - stored data ..... 30
-

## Index

---

- Display Options ..... 97
- display screen ..... 21
- dissolved oxygen, measuring ..... 79
  - See *also* LDO methods; LDO probe
- downloading data
  - sending data to a computer ..... 34
  - sending data to a printer ..... 33
  - transferring calibration data ..... 34
  - viewing downloaded data files ..... 42
- dual display screen ..... 21
  
- E**
- e-mail customer support ..... 107
- EMI Immunity ..... 111
- Emissions Standards ..... 112
- end-of-life waste disposal ..... 7
- errors, probe calibration
  - Slope out of range ..... 48, 81
  - Standard not recognized ..... 48
- European Union regulations ..... 7
  
- F**
- Fahrenheit, settings ..... 99
- FCC statement ..... 112
- features ..... 8
- flash sticks, transferring data to ..... 16
  
- I**
- installing batteries ..... 12
- Instrument Information, viewing ..... 97
- Interval measurement mode
  - auto measurement intervals, setting ..... 95
  - data log overflow ..... 96
  - selecting ..... 94
  - starting measurements ..... 96
  
- K**
- key press options ..... 98
- keypad ..... 20
  
- L**
- labels, precautionary ..... 7
- language, selecting ..... 22
  
- LDO methods
  - averaging interval ..... 85
  - calibration options ..... 86
  - limits ..... 84
  - measurement options ..... 83
  - modifying ..... 83
  - new, creating ..... 82
  - pressure units ..... 85
  - resolution ..... 84
  - salinity correction ..... 85
  - units ..... 86
- LDO probe
  - calibrating ..... 79
  - measuring dissolved oxygen ..... 79
  - specifications ..... 9
- limits
  - conductivity ..... 69
  - LDO ..... 84
  - pH ..... 54
- logs
  - Calibration ..... 29
  - Check Standards ..... 29
  - data overflow ..... 96
  - Reading ..... 29
- luminescent dissolved oxygen. See LDO methods; LDO probe
  
- M**
- maintenance ..... 101
- measurement modes, selecting ..... 94
- measurement options
  - conductivity ..... 67, 69
  - LDO ..... 83
  - pH ..... 53
- measuring
  - conductivity, salinity, resistivity, or TDS ..... 64
  - dissolved oxygen ..... 79
  - pH ..... 49
- meter cleaning ..... 101
- methods
  - archiving and exchanging ..... 45
  - deleting ..... 89
  - pH ..... 51
  - selecting ..... 88
- model number ..... 97
- models ..... 8
  
- O**
- on/off key ..... 14

- 
- Operator ID
- creating ..... 27
  - deleting ..... 28
  - displaying ..... 26
  - selecting ..... 27
- ordering parts ..... 107
- overflow, data ..... 96
- oxygen, measuring dissolved ..... 79
- See also LDO methods; LDO probe
- P**
- packing slip ..... 11
- part number, AC power supply ..... 12
- parts
- numbers ..... 103
  - ordering ..... 107
- passwords, Access Control ..... 92
- PCs, transferring data to ..... 16
- pH
- calibrating probe ..... 47
  - deferring Check Standards ..... 51
  - measuring ..... 49
  - probe specifications ..... 9
  - running Check Standards ..... 49
- pH methods
- calibration options ..... 55
  - Check Standard options ..... 59
  - creating new ..... 51
  - limits ..... 54
  - measurement options ..... 53
  - modifying ..... 53
  - resolution ..... 54
  - units ..... 62
- phone numbers
- ordering parts ..... 107
  - repair service ..... 109
  - support ..... 107
- power on/off key ..... 14
- power requirements ..... 9
- power supply, AC ..... 12, 111
- Press to Read measurement mode ..... 94
- pressure units, LDO methods ..... 85
- printers, transferring data to ..... 16
- printing
- sending data to a printer ..... 33
- probes
- calibrating conductivity ..... 63
  - calibrating LDO ..... 79
  - calibrating pH ..... 47
  - cleaning ..... 101
  - connectors ..... 14
  - display screen ..... 21
  - Instrument Information ..... 97
  - measuring conductivity, salinity, resistivity, or TDS  
64
  - measuring dissolved oxygen ..... 79
  - measuring pH ..... 49
  - part numbers ..... 103
  - Slope out of range error ..... 48, 81
  - specifications ..... 9
  - Standard not recognized error ..... 48
  - viewing data ..... 29
- R**
- Reading Log
- displaying ..... 29
- rechargeable batteries ..... 12
- recycling ..... 7
- reference temperature, conductivity methods ..... 71
- reminders, calibration
- conductivity ..... 72
  - pH ..... 56
- repair ..... 109
- report options ..... 31
- resistivity, measuring ..... 64
- resolution
- LDO methods ..... 84
  - pH method ..... 54
- Run Check Standards
- conductivity ..... 65
  - pH ..... 49
  - settings ..... 93
- S**
- safety information ..... 7, 111
- salinity
- correction, LDO methods ..... 85
  - measuring ..... 64
- Sample ID
- creating ..... 25
  - deleting ..... 26
  - Reading Log ..... 29
  - selecting ..... 26
- screen, display ..... 21
- sending data
- features ..... 16
  - to flash stick or printer ..... 31
-

## Index

---

- serial number ..... 8, 97
- service ..... 109
- single display screen ..... 21
- Slope out of range error ..... 48, 81
- softkeys ..... 20
- software
  - updating ..... 101
- sound options ..... 98
- specifications ..... 9
- Standard not recognized calibration error ..... 48
- standards. See Check Standards
- stored data
  - deleting ..... 30
  - viewing ..... 28
- support ..... 107
- symbols, safety ..... 7
  
- T**
- TDS, measuring ..... 64
- technical support ..... 107
- telephone numbers
  - ordering parts ..... 107
  - repair service ..... 109
  - support ..... 107
- temperature
  - correction, conductivity methods ..... 70
  - specifications ..... 9
  - units, setting ..... 99
- time, setting ..... 22
- transferring data
  - features ..... 16
  - to flash stick or printer ..... 31
- troubleshooting probe calibration
  - Slope out of range error ..... 48, 81
  - Standard not recognized error ..... 48
  
- U**
- units
  - conductivity methods ..... 69
  - LDO methods ..... 86
  - pH methods ..... 62
  - temperature, setting ..... 99
- unpacking instrument components ..... 11
- updating software ..... 101
- USB connector ..... 16
- USB update function ..... 101
- user interface ..... 91
  
- V**
- version number ..... 97
- Viewing ..... 40
  
- W**
- warranty ..... 113
- waste disposal ..... 7
- waterproof features ..... 8

## LDO101-05, LDO101-10, LDO101-15, or LDO101-30 Probe



---

### CAUTION

**BEFORE ATTACHING THE PROBE FOR THE FIRST TIME:** Set the date and time in the meter before attaching the probe for the first use. If the meter date and time are incorrect when the probe is installed, the probe will retain this incorrect time stamp for the remainder of its service life, even if the meter time and date have subsequently been corrected.

## Safety

To ensure that the protection provided by this equipment is not impaired, do not use or install this equipment in any manner other than that specified in this document.

	This symbol, if noted on the instrument, references the instruction manual for operation and/or safety information.
	<p><b>Electrical equipment marked with this symbol may not be disposed of in European public disposal systems after 12 August of 2005. In conformity with European local and national regulations (EU Directive 2002/96/EC), European electrical equipment users must now return old or end-of life equipment to the Producer for disposal at no charge to the user.</b></p> <p><b>Note:</b> For return for recycling, please contact the equipment producer or supplier for instructions on how to return end-of-life equipment, producer-supplied electrical accessories, and all auxiliary items for proper disposal.</p>

### CAUTION

**When deploying the probe at a distance, toss the probe body with a gentle underhand throw. Swinging the probe by the cable may cause injury to the user, will cause severe strain on the probe cable, and will shorten service life. Damage incurred in this manner will not be covered by the product warranty.**

## Overview

Figure 1 shows the LDO101-05, LDO101-10, LDO101-15, or LDO101-30 Probe, a luminescent dissolved oxygen (LDO) probe with a bell-and-ring shroud. The probe can be equipped with a 5-, 10-, 15-, or 30-meter cable. The probe is designed for fast, accurate measurement of dissolved oxygen concentration in wastewater, drinking water, and general applications.

Each probe is supplied with color-code clips for easy identification. There are two each of five colors (black, yellow, light green, light blue, and magenta), one for the probe and one for the cable connector. Attach a pair of color-code clips to the probe and cable connector.

Replacement sensor caps (including the iButton®\*) are available (Cat. No. 58112-00).

Optional probe-cable depth markers are also available (Cat. No. 58286-10).

---

\* iButton is a registered trademark of Maxim Integrated Products, Inc.

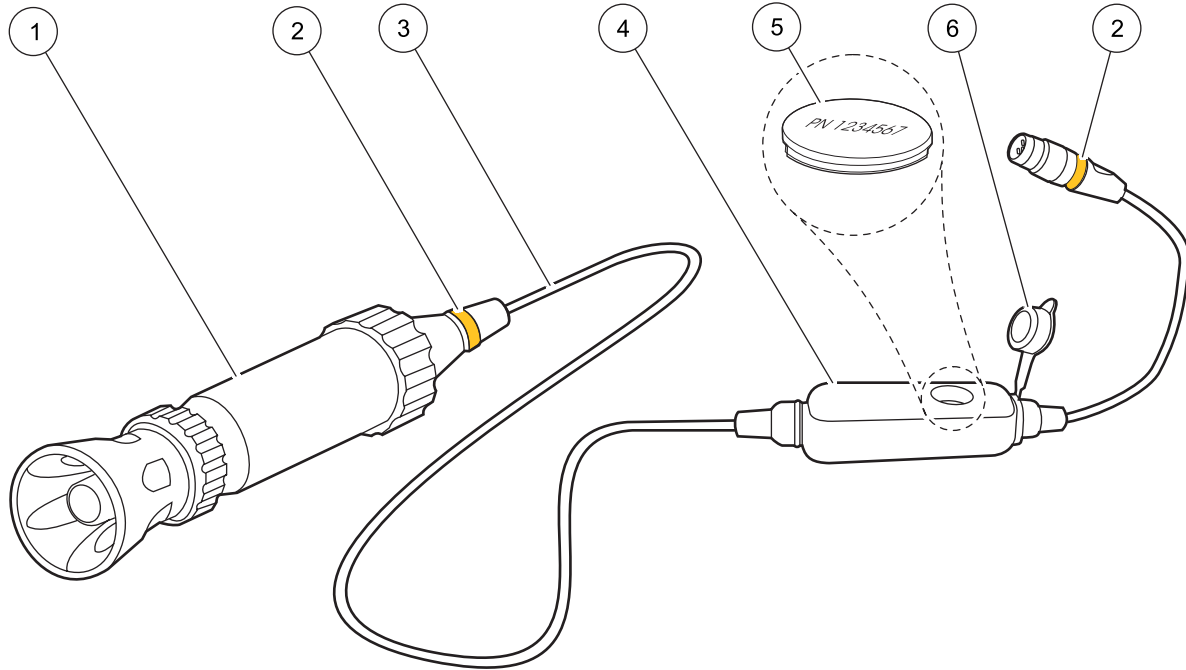


Figure 1 The LDO101-05, LDO101-10, LDO101-15, or LDO101-30 Probe

1	Probe Body with Shroud	4	Pressure-sensor Module
2	Locations for Color Code Clip Installation	5	iButton®
3	5-, 10-, 15-, or 30-meter Cable	6	Cap

## Removing and Replacing the Shroud

**Important Note:** Do not remove the cable from the probe. Doing so can damage the probe.

The LDO101 Probe comes fully assembled. Remove the shroud to change the sensor cap or calibrate the probe. Refer to the Sensor Cap Instruction Sheet for information on changing the sensor cap (Cat. No. 5811289).

### Removing the Shroud

1. Hold the shroud (Figure 2, item 1) and unscrew the locking ring (Figure 2, item 2).
2. Pull the shroud toward the sensor end of the probe. Resistance will be felt until the locking ribs on the shroud disengage from the locking groove on the probe body.
3. Completely remove the shroud and locking ring and set them aside.

### Replacing the Shroud

1. Place the locking ring (Figure 2, item 2) on the probe body with the threads toward the shroud (Figure 2, item 1).
2. Slide the shroud onto the probe until the locking ribs (Figure 2, item 4) are seated in the locking groove (Figure 2, item 7).
3. Screw the locking ring onto the threads.
4. Hold the shroud and hand-tighten the locking ring.

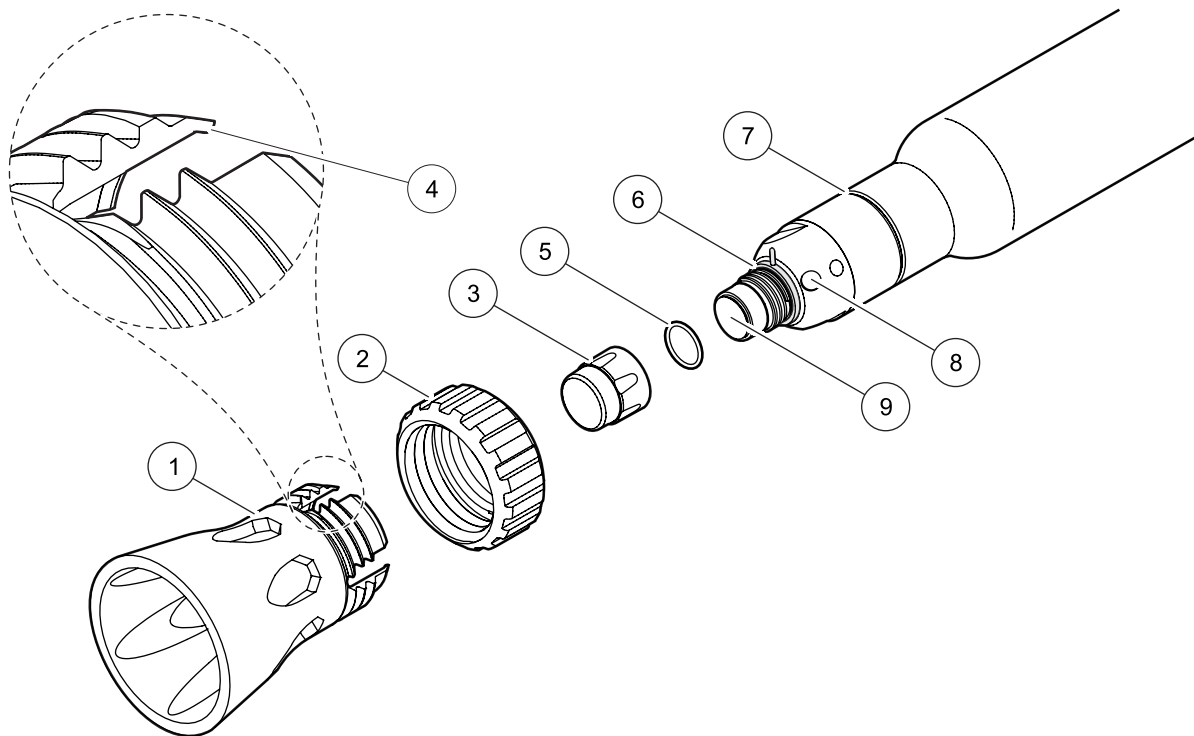


Figure 2 Shroud and Sensor Cap Removal

1	Shroud	6	Cap Seal
2	Locking Ring	7	Locking Groove
3	Sensor Cap	8	Temperature Sensor
4	Locking Ribs (4x)	9	Sensor Lens
5	O-ring		

### Calibration

Each lot of LDO sensor caps is factory-calibrated. For best performance, a one-time calibration initialization can be performed when a new sensor is installed. Additional calibrations can be performed but are not required.

For calibration steps, refer to the *HQ Portable Meters User Manual*. The IntelliCAL™ probes store the current calibration and calibration history in the probe memory. It is not necessary to recalibrate when moving a calibrated probe from one meter to another.

## Maintenance

**Important Note:** Do not scrub the sensor cap or the sensor lens.

**Important Note:** Do not use organic solvent solutions such as acetone or methanol with the LDO101 sensor cap. These solvents will damage the plastic sensor cap.

### General Maintenance

- After use, visually inspect the sensor cap. Use optical tissue or a cotton swab with soapy water to clean the sensor cap (Figure 2, item 3). Rinse with fresh water.
- Before measuring a new sample, rinse the probe with deionized water and blot dry with a paper towel.
- If the cap is sealed properly using the top O-ring seal, no water should be present between the sensor cap and the clear plastic sensor lens (Figure 2, item 9) at the top of the probe. If water is present, remove the cap and thoroughly dry the inside of the cap and the sensor lens. The cap may require replacement (Cat. No. 58112-00).

### Storage

- Between uses, store the probe dry in ambient conditions.

## Specifications

Specifications are subject to change without notice.

<b>Dissolved Oxygen Range</b>	0.1–20.0 mg/L (ppm) 1–200% saturation
<b>Dissolved Oxygen Accuracy</b>	± 0.1 mg/L for 0–8 mg/L ± 0.2 mg/L for greater than 8 mg/L
<b>% Saturation Resolution</b>	0.1%
<b>% Saturation Accuracy</b>	± 1% of reading
<b>Temperature Range</b>	0–50 °C
<b>Temperature Resolution</b>	0.1 °C
<b>Temperature Accuracy</b>	± 0.3 °C
<b>Pressure Resolution</b>	1 hPa
<b>Pressure Accuracy</b>	± 0.8%
<b>Warranty</b>	Probe is covered by a three-year warranty. Sensor cap is covered by a one-year warranty.



FOR TECHNICAL ASSISTANCE, PRICE INFORMATION AND ORDERING:  
 In the U.S.A. – Call toll-free 800-227-4224  
 Outside the U.S.A. – Contact the HACH office or distributor serving you.  
 On the Worldwide Web – [www.hach.com](http://www.hach.com); E-mail – [techhelp@hach.com](mailto:techhelp@hach.com)

HACH COMPANY  
 WORLD HEADQUARTERS  
 Telephone: (970) 669-3050  
 FAX: (970) 669-2932





# LDO™ Sensor Replacement Kit

For use with Hach LDO101 Standard and Rugged Dissolved Oxygen Probes

User Manual





# LDO™ Sensor Replacement for LDO101 Probes

---

Each LDO sensor cap replacement kit comes with a sensor-specific calibration update iButton®. When the iButton is installed in the pressure-sensor module (located on the LDO101 probe cable), the probe calibration is updated for the new sensor cap.

The kit includes:

- Sensor cap with O-ring and seal
- Calibration update iButton

## Replacing the Sensor Cap and iButton

1. Disconnect the LDO101 probe from the meter. If using a rugged LDO101 probe, remove the protective shroud from the end of the probe.
2. Remove the used sensor cap from the probe and discard. Do not touch or soil the exposed sensor lens (Figure 1).
3. Carefully remove the used O-ring from the sensor tip. Remove the used cap seal by rolling it off with your fingers. Do not use sharp metal tools.

## LDO™ Sensor Replacement for LDO101 Probes, continued

---

4. Position the new cap seal on the probe body with the narrow shoulder of the seal facing the probe tip (Figure 1). Slide the seal until it rests against the probe body threads.
5. Place the new O-ring into the groove at the sensor tip (Figure 1). Do not touch the sensor lens.

**Note:** *If the sensor lens is soiled, rinse with dilute isopropyl alcohol or deionized water and blot completely dry. Do not wipe the lens or use abrasive cleaners.*

6. Finger-tighten the new sensor cap onto the probe until the seal is compressed. Do not over-tighten. The cap will push the seal over the threads and into position (Figure 1). Do not touch or soil the sensor lens.

**Note:** *Avoid handling the black face of the sensor cap. DO NOT use alcohol or other organic solvents to clean the black face of the sensor cap. These solvents will destroy the sensor cap.*

7. Inspect the cap seal to make sure the narrow shoulder of the seal is inside the cap.

## LDO™ Sensor Replacement for LDO101 Probes, continued

---

8. Pull to open the iButton®\* cover on the pressure-sensor module (Figure 1). Tip the module to remove the existing iButton.
9. Verify that the lot code printed on the new iButton matches the lot code on the new sensor cap (Figure 2).
10. Insert the new iButton with the paper label facing up.
11. Close the iButton cover and press until it seats against the surface of the module housing. The cover must be seated properly to ensure good electrical contact with the iButton and to ensure a proper seal.
12. Re-assemble the protective shroud and ring (if using the rugged probe) and re-connect the LDO101 probe to the meter.

**Note:** Changing the iButton resets the stored calibration to correspond to the new sensor. If the meter was calibrated manually, the **PROBE ?** icon will appear to indicate that the manual calibration is not valid for use with the new sensor.

---

\* iButton is a registered trademark of Maxim Integrated Products, Inc.

## LDO™ Sensor Replacement for LDO101 Probes, continued

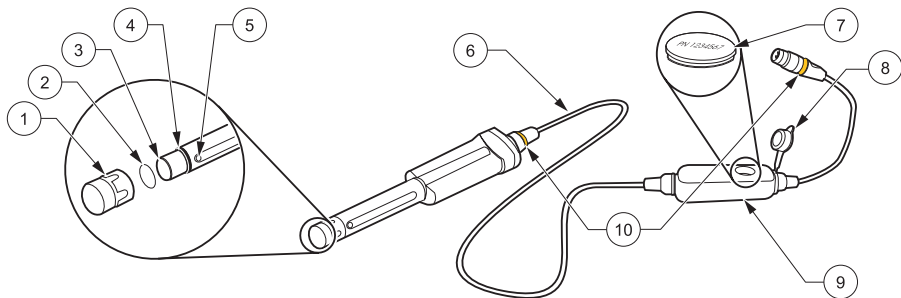


Figure 1 LDO101 Standard Probe—Sensor Cap and iButton

<b>1</b> Sensor Cap	<b>6</b> 1- or 3-meter Cable
<b>2</b> O-ring	<b>7</b> iButton
<b>3</b> Sensor Lens	<b>8</b> iButton Cover
<b>4</b> Cap Seal	<b>9</b> Pressure-sensor Module
<b>5</b> Temperature Sensor	<b>10</b> Location for Color-code Clips

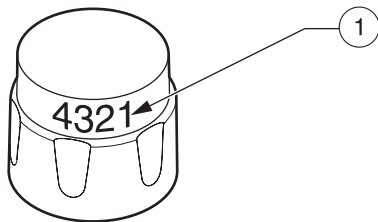


Figure 2 Sensor Cap

1 Lot Code on Sensor Cap

## LDO™ Sensor Replacement for LDO101 Probes, continued

---

### Replacement Parts

Description	Quantity	Catalog Number
LDO Sensor Replacement Kit for LDO101 Probes	1	58112-00
Instruction Manual for Sensor Replacement	1	58112-89



**FOR TECHNICAL ASSISTANCE, PRICE INFORMATION AND ORDERING:**

In the U.S.A. – Call toll-free 800-227-4224

Outside the U.S.A. – Contact the HACH office or distributor serving you.

On the Worldwide Web – [www.hach.com](http://www.hach.com); E-mail – [techhelp@hach.com](mailto:techhelp@hach.com)

**HACH COMPANY**  
WORLD HEADQUARTERS  
Telephone: (970) 669-3050  
FAX: (970) 669-2932





**STANDARD OPERATING PROCEDURE**  
**MAINE VOLUNTEER RIVER MONITORING PROGRAM**  
**METHODS FOR USING THE YSI550A**  
**HANDHELD METER IN RIVERS AND STREAMS**



**Note:** The mention of brand names does not constitute recommendation of a specific company.



## Volunteer River Monitoring Program (VRMP)

### Standard Operating Procedure Methods for using the YSI 550A Handheld Meter

**1. Applicability.** This standard operating procedure (SOP) is used by the Volunteer River Monitoring Program (VRMP) of the Maine Department of Environmental Protection's (DEP's) Bureau of Water Quality, Division of Environmental Assessment, Watershed Management Unit. It applies to the collection of dissolved oxygen (DO) and temperature from rivers and streams in Maine using the YSI 550A handheld meter.

**2. Purpose.** This purpose of this SOP is to provide standardized methods for volunteer groups to determine dissolved oxygen of rivers and streams by volunteers as an instantaneous reading using the YSI 550A handheld meter.

#### 3. Definitions.

**A. YSI.** Yellow Springs International, manufacturer of water quality monitoring meters.

**B. Probe.** Sensing device located at the end of a cable that is attached to the meter.

**C. KCl solution.** Potassium Chloride solution used to fill the probe.

**D. Calibration.** Set of procedures established by the manufacturer to ensure that the meter is operating properly; a critical quality assurance step in meter preparation prior to use.

**E. Membrane.** A clear, transparent and paper-thin substance similar to cellophane on the end of the probe. The membrane is permeable and allows gases such as oxygen to pass through into probe sensors while at the same time isolating most other undesirable substances.

**F. Jigging.** To move the probe under water using steady movements. Unless the probe is being held in swiftly flowing water, the probe shall be moved ("jigged") approximately 1/2 foot per second to overcome the inherent consumption of oxygen by the sensor.

#### 4. Responsibilities.

**A. Volunteer Monitors & Volunteer Groups**



- **Certification.** It is the responsibility of the individual obtaining this data to maintain current certification for the parameter(s) they collect if they wish their data to be entered into the VRMP database. Training will be provided to volunteers on an annual basis by VRMP/DEP staff, and certification will last for one year from the date of training.
- **Data Recording.** It is the responsibility of the individual obtaining this data to record the results and additional qualifying information on current field sheets obtained from their affiliated watershed association or through the VRMP program of the DEP.
- **Data Quality Checks and Data Submission.** The data manager for the volunteer group will collect and enter volunteer field sheet data onto the appropriate computer file, perform quality assurance checks (Refer to Section 5.10 of the Quality Assurance Program Plan), and submit data to the VRMP following protocols outlined in the volunteer group's latest sampling and analysis plan (SAP) that has been approved by the VRMP.

#### ***B. Volunteer River Monitoring Program (VRMP) Staff***

- **Oversight of Volunteer Groups and Volunteers.** VRMP staff will oversee volunteer groups and volunteers through a variety of ways including maintaining an up-to-date VRMP quality assurance program plan (QAPP); reviewing sampling and analysis plans (SAPs) of the volunteer groups; providing annual training/certification sessions for volunteers; conducting quality assurance checks on data submitted by volunteer groups and laboratories; and uploading data into the DEP's EGAD (Environmental and Geographic Analysis Database) database. These tasks are described in greater detail in the VRMP's latest QAPP.

### **5. Guidelines and procedures.**

#### ***A. YSI 550A Meter Preparation.***

- **First time use.** Follow manufacturer's instructions for preparing meter for first time use. (Refer to Appendix A; "Initial Inspection", pg. 1 and "Preparing the Probe, pg. 5).
- **Beginning of field season.** Before each field season, volunteer monitoring groups shall conduct a full inspection of the meter. If membrane has been stored dry, follow manufacturer's instructions for first time use (see above). A new membrane and batteries shall be installed prior to the start of field sampling and additionally, as needed (refer to Appendix A, "Preparing the Probe", pg. 5). VRMP staff will check meter against "benchmark" DO meter accuracy at DEP lab. In addition, each meter "setup" should be equipped with the following items so that field repairs can be undertaken as necessary:



- Extra KCL fluid and membrane caps for probe
  - Extra batteries
  - Field data sheet
  - Screwdriver for removing back of meter to replace batteries
  - Pencil with eraser
- **Prior to field sampling.** Before each field sample collection, the volunteer shall inspect the meter including an inspection of the condition of the probe membrane, membrane, and batteries.
    - (1) Check the membrane for air bubbles and wrinkles. If bubbles or wrinkles are present, remove membrane, refill with KCL solution, and replace membrane (Refer to Appendix A, “Membrane Cap Installation”, pg. 5).
    - (2) Check to make sure drops of water are not clinging to the membrane. If drops are present, blow on membrane to gently remove droplets. Don't tap; these probes are very fragile. Replace probe into the calibration chamber on the side of the meter.
    - (3) Batteries should be checked for charge and/or expiration.
    - (4) Be familiar with the testing, inspection, maintenance, and calibration considerations described in sections 5.6 through 5.8 of the VRMP QAPP (MDEP, 2019).
    - (5) Power on the meter and allow sufficient warm-up time (20 min) prior to initial use for the day.
  - **Dissolved Oxygen Calibration.** If collecting dissolved oxygen measurements, the YSI 550A meter shall be calibrated each time the unit is turned on. Meters shall be calibrated to a 100% water-saturated air environment (for instructions, refer to Appendix A, “Dissolved Oxygen Calibration”, pgs. 6-7).
  - **Dissolved Oxygen Check Against “Zero Dissolved Oxygen” Standard.** VRMP staff shall check DO meters using zero oxygen solution at the beginning of the field season. Volunteers shall check their DO meter using zero oxygen solution mid-season and at the end of the field season. The zero oxygen solution is provided from VRMP/DEP staff. Volunteers shall record the dissolved oxygen value they measure with their meter in the appropriate blank on the field data sheet. (See section 5-B of this SOP for instructions on how to make measurements with the YSI 550A meter.)

#### ***B. Dissolved Oxygen and Temperature Measurements.***

- **Sampling Period and Site Location.** Sampling period and site location information will be documented in the volunteer groups’ SAPs (that require approval by the VRMP) which are submitted by the volunteer groups prior to any sampling. (Detailed information regarding how volunteer groups are to obtain and document site location information can be found in VRMP SOP-02 [Methods for Selecting and Documenting Site Locations].)



- **Sample Timing.** Dissolved oxygen data collected between dawn and 8 am are important for assessment of attainment of DO criteria within Maine’s Water Quality Standards. But, except as naturally occurs, DO concentrations below the applicable DO criteria at any time of day signal non-attainment. If there are no DO concentrations below the criteria after 8 am, then data between dawn and 8 am must be collected to assess attainment of the criteria.
- **Familiarize Yourself with the Meter.** Familiarize yourself with the basic operation, keypad, and readouts of the meter (Appendix A, “General Description”, pg. 1, “Features of the YSI 550A”, pgs. 3 – 4 and “Principles of Operation”, pg. 5).
- **General Sampling Protocol.**
  - (1) Record site location on data sheet.
  - (2) Remove probe from calibration chamber.
  - (3) Submerge probe in the water at the site where you are monitoring, as described in your group’s approved SAP.
  - (4) For either parameter (DO or temperature), allow the reading to stabilize (at least 15 seconds) before recording the value on the field sheet.
  - (5) Follow the instructions below measuring specific parameters.
  - (6) The meter should remain turned on between stations, unless time between samplings exceeds 30-60 minutes. If meter is turned off, the field probe should be stored inside the calibration chamber during transport, sufficient time (20 min) should be allowed for warm-up, and the meter should be re-calibrated.
- **Dissolved Oxygen Measurements.**
  - (1) Review and follow the instructions for making DO measurements in Appendix A, “Probe Operation: Measurement Procedure”, pg. 8. Make sure units are taken in mg/L (or ppm).
  - (2) *Note of caution:* Unless the probe is equipped with a stirrer, jiggling of the probe is extremely important for obtaining accurate dissolved oxygen readings, unless you have placed the probe in a swiftly-moving section of stream or river. (The probe is dependent on the amount of oxygen that passes across the membrane, and the probe actually consumes oxygen as it is making measurements.) An up-and-down motion (jiggling) creating movement of 1/2 foot per second is recommended.
- **Temperature Measurements.**
  - (1) Review and follow the instructions for making temperature measurements in “Measurement Procedure”, pg. 8.
- **Quality Control.**
  - (1) At the beginning of each field season, all VRMP staff and VRMP volunteers who collect dissolved oxygen, temperature, specific conductance, and salinity data will have a training/refresher/certification session to (re)familiarize themselves with the contents of this SOP.



- (2) For every volunteer, a field duplicate shall be obtained for all parameters for at least 10% of their own sampling efforts. A field duplicate will be collected for every 10 samples monitored.
- (3) Refer to the VRMP quality assurance project plan (QAPP) for more QA/QC details.

## 6. Equipment Care.

### A. *Start of field season.*

1. Follow manufacturer's directions for preparation of a new probe or renewing probe in the spring (refer to Appendix A; "Preparing the Probe", pg. 5 and "Probe Electrode Maintenance", pg. 9-10). Be sure to replace membrane at the start of each sampling season.
2. Use new batteries at start of each sampling season. An extra set of appropriate size batteries should be included in the meter carrying case.
3. If needed, clean the probe (anode and cathode) according to manual directions.
4. Each DO meter should be equipped with extra items for making repairs in the field. See section 5-A of this SOP for a list of items.

### B. *Field Season*

1. Ideally the meter should be in water-resistant case with padding to protect it from damage.
2. Allow the case and contents to air-dry at end of each day. This may be accomplished by simply propping the lid open. When contents are very wet, remove the contents and spread out to facilitate drying.
3. Keep meter from freezing.
4. Refer to Appendix A, "Probe Electrode Maintenance", pg. 9 – 10 for manufacturer's recommendations for maintenance requirements.

### C. *End of field season*

1. Completely dry meter, case, and all items in the case before storing.
2. Remove batteries.
3. Remove membrane cap, rinse, and dry.
4. Rinse entire probe and calibration chamber with distilled water.
5. Put membrane cap back on to keep dust and dirt out for winter.
6. Keep meter dry and at room temperature to prevent corrosion of electronic parts.
7. Review Appendix A for more tips.
8. Record winterization date and equipment repairs in your volunteer group's Equipment Log.
9. Label the meter and case as 'WINTERIZED' in an obvious manner (so users will know the current status of the unit).



## 7. Specifications

Measurement	Range	Resolution	Accuracy
Temperature	-5 °C to 45 °C	0.1 °C	±0.3 °C
Dissolved Oxygen (%)	0 to 200%	0.1% or 1% user selectable	±2% air sat or ±2% of reading, whichever is greater
	200 to 500%		±6% of reading
Dissolved Oxygen (mg/L)	0 to 20 mg/L	0.01 mg/L or 0.1 mg/L, user selectable	±0.3 mg/L or ±2% or reading, whichever is greater
	20 to 50 mg/L		±6% of reading

## 8. Appendix

### A. YSI Meter owner's manual:

YSI Incorporated. 2002. YSI Model 550A Dissolved Oxygen Instrument Operations Manual. Yellow Springs, Ohio.

## 9. References

### A. DEP Standard Operating Procedures:

- Document number #: DEP-LW0890: Dissolved Oxygen and Temperature, Instantaneous Measurement using Electronic Meters

### B. Maine VRMP QAPP:

- Maine Department of Environmental Protection (DEP). 2020. Maine Volunteer River Monitoring Program (VRMP) Quality Assurance Program Plan (VRMP). Portland, ME. DEPLW-0984.



**YSI Environmental**

Pure  
Data for a  
Healthy  
Planet.™



**YSI 550A**  
Dissolved Oxygen Instrument

**Operations**  
**Manual**





# CONTENTS

---

CONTENTS.....	iii
GENERAL DESCRIPTION.....	1
WARRANTY .....	2
FEATURES OF THE YSI 550A .....	3
PRINCIPLES OF OPERATION .....	5
PREPARING THE PROBE .....	5
DISSOLVED OXYGEN CALIBRATION .....	6
SALINITY COMPENSATION CALIBRATION .....	7
PROBE OPERATION .....	8
PROBE ELECTRODE MAINTENANCE .....	9
ACCESSORIES/REPLACEMENT PARTS .....	10
SPECIFICATIONS .....	11
TROUBLESHOOTING.....	12
CONTACT INFORMATION .....	13
REQUIRED NOTICE .....	14



# GENERAL DESCRIPTION

---

The YSI 550A Handheld Dissolved Oxygen Instrument is a rugged, microprocessor based, digital instrument with a field-replaceable YSI dissolved oxygen probe. The YSI 550A DO Instrument is impact-resistant and waterproof.

The YSI 550A DO Instrument is designed for field use and is available with cable lengths of 12, 25, 50, or 100 feet (3.5, 7.5, 15, 30.5 meters). The body of the probe has been manufactured with stainless steel to add rugged durability and sinking weight. The large Liquid Crystal Display (LCD) is easy to read and is equipped with a backlight for use in dark or poorly lighted areas.

The YSI 550A DO Instrument can be easily calibrated with the press of a few keys. Additionally, the instrument's microprocessor performs a self-diagnostic routine each time the instrument is turned on. The self-diagnostic routine provides you with useful information about the function of the instrument circuitry and the quality of the readings you obtain.

The system displays temperature in either °C or °F and dissolved oxygen in either mg/L (milligrams per liter) or % air saturation. The system requires only a single calibration regardless of which dissolved oxygen display is used, and will calibrate in either mode. Salinity compensation values can be changed at any time without performing a new calibration.

A detachable calibration chamber is mounted to the back of the instrument. A small sponge in the chamber can be moistened to provide a water saturated air environment that is ideal for air calibration. This chamber is also designed for transporting and storing the probe. When the probe is stored in the chamber, the moist environment will prolong effective membrane performance and probe life.

The YSI 550A DO Instrument is powered by 4 C-size alkaline batteries. A new set of alkaline batteries will provide approximately 2000 hours of continuous operation. If the backlight is used often, batteries will be depleted faster.

The YSI 550A case is waterproof with an IP-67 rating. The instrument is 100% corrosion proof and can be operated in a wet environment without damage to the instrument.

## INITIAL INSPECTION

When you unpack your new YSI 550A DO Handheld Instrument for the first time, check the packing list to make sure you have received everything. If there is anything missing or damaged, call the dealer from whom you purchased the YSI 550A. If you do not know which authorized dealer sold the system to you, call YSI Customer Service at 800-897-4151 or 937-767-7241.

# WARRANTY REGISTRATION

Please complete the Product Registration on the YSI website at [www.ysi.com](http://www.ysi.com). If you are not online, you may complete the Warranty Card included with your instrument and return it to YSI Incorporated. Your purchase of this quality instrument will then be recorded in YSI's customer database. Once your purchase is recorded, you will receive prompt, efficient service in the event any part of your YSI 550A DO Instrument should ever need repair.

## WARRANTY

---

The YSI 550A DO Instrument is warranted for three years from date of purchase by the end user against defects in materials and workmanship. YSI 550A DO probes and cables are warranted for one year from date of purchase by the end user against defects in material and workmanship. Within the warranty period, YSI will repair or replace, at its sole discretion, free of charge, any product that YSI determines to be covered by this warranty.

To exercise this warranty, write or call your local YSI representative, or contact YSI Customer Service in Yellow Springs, Ohio. Send the product and proof of purchase, transportation prepaid, to the Authorized Service Center selected by YSI. Repair or replacement will be made and the product returned, transportation prepaid. Repaired or replaced products are warranted for the balance of the original warranty period, or at least 90 days from date of repair or replacement.

### Limitation of Warranty


This Warranty does not apply to any YSI product damage or failure caused by (i) failure to install, operate or use the product in accordance with YSI's written instructions, (ii) abuse or misuse of the product, (iii) failure to maintain the product in accordance with YSI's written instructions or standard industry procedure, (iv) any improper repairs to the product, (v) use by you of defective or improper components or parts in servicing or repairing the product, or (vi) modification of the product in any way not expressly authorized by YSI.


THIS WARRANTY IS IN LIEU OF ALL OTHER WARRANTIES, EXPRESSED OR IMPLIED, INCLUDING ANY WARRANTY OF MERCHANTABILITY OR FITNESS FOR A PARTICULAR PURPOSE. YSI's LIABILITY UNDER THIS WARRANTY IS LIMITED TO REPAIR OR REPLACEMENT OF THE PRODUCT, AND THIS SHALL BE YOUR SOLE AND EXCLUSIVE REMEDY FOR ANY DEFECTIVE PRODUCT COVERED BY THIS WARRANTY. IN NO EVENT SHALL YSI BE LIABLE FOR ANY SPECIAL, INDIRECT, INCIDENTAL OR CONSEQUENTIAL DAMAGES RESULTING FROM ANY DEFECTIVE PRODUCT COVERED BY THIS WARRANTY.

# FEATURES OF THE YSI 550A

---

## KEYPAD

 Powers the unit on or off. The instrument will activate all segments of the display for a few seconds, and then will show a self-test procedure for several more seconds. During this power on self-test sequence, it is normal for error messages to appear and disappear. If the instrument were to detect a problem, a **continuous** error message would be displayed.

 Turns the display backlight on or off. The light will turn off automatically after two minutes of non-use.

**Mode** During DO calibration it allows the user to select between % and mg/L. After selection, it may be pressed several times to exit back to measurement mode without completing the calibration. During measurement, it switches the instrument display between DO %, DO mg/L, and salinity calibration.

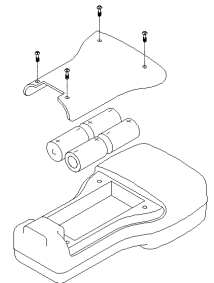
**▲ and ▼** Increases or decreases the value during calibrations.

**▼ and Mode** Press at the same time to switch the temperature units between Fahrenheit (F) and Celsius (C).

**▲ and Mode** Press at the same time to increase or decrease the resolution of the instrument in mg/L or % measurement mode.

## BATTERIES

The YSI 550A DO Instrument is powered by 4 C-size alkaline batteries. A new set of alkaline batteries will provide approximately 2000 hours of continuous operation. When batteries need to be replaced, the LCD will display a "**LO BAT**" message. When the message first appears, the instrument will have approximately 50 hours of life left, provided the back light is not used.



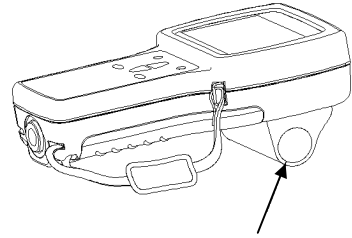
## INSTRUMENT CASE

The waterproof instrument case is sealed at the factory and is not to be opened, except by authorized service technicians.

**Caution:** Do not attempt to separate the two halves of the instrument case as this may damage the instrument, break the waterproof seal, and will void the manufacturer's warranty.

## CALIBRATION/STORAGE CHAMBER

The YSI 550A DO Instrument has a convenient calibration/storage chamber that can be attached to the instrument's back. The calibration chamber can be used from either side of the instrument, by moving the rubber stopper to either end.

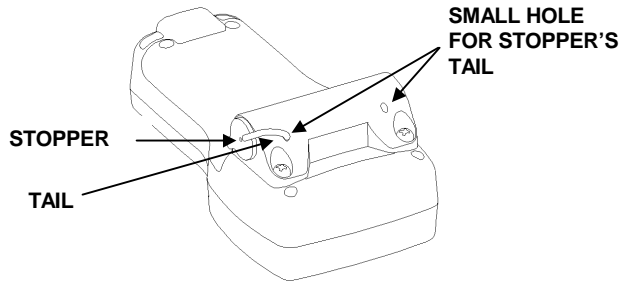


**CALIBRATION CHAMBER**

If you look into the chamber, you should notice a small round sponge in the bottom. Carefully put 3 to 6 drops of clean water into the sponge. Turn the instrument over and allow any excess water to drain out of the chamber. The wet sponge creates a 100% water saturated air environment for the probe. This environment is ideal for dissolved oxygen calibration and for storage of the probe during transport and non-use.

The YSI 550A DO Instrument's storage chamber can be conveniently used from either side of the instrument.

1. Remove the chamber from the instrument by unscrewing the two screws.
2. Remove the rubber stopper from the chamber by pulling the "tail" free of the small hole on the chamber.
3. Re-attached the rubber stopper to the storage chamber by threading the "tail" through the opposite small hole on the chamber.
4. Re-attached the storage chamber to the instrument using the two screws.



## HAND STRAP

The hand strap is designed to allow comfortable operation of the YSI 550A DO Instrument with minimum effort. If the hand strap is adjusted correctly, it is unlikely that the instrument will be dropped or bumped from your hand. The hand strap can be conveniently used from either side of the instrument.

To switch the hand strap from one side to the other:

1. Pull the two velcro strips apart.
2. Pull the strap free of the upper and lower hooks.
3. Feed the strap through the hooks on the other side of the instrument.
4. Adjust the strap length so that your hand is snugly held in place.
5. Press the two velcro strips back together.

# PRINCIPLES OF OPERATION

---

The sensor consists of a silver body as the anode and a circular gold cathode embedded in the end. In operation, this end of the sensor is filled with a solution of electrolyte containing a small amount of surfactant to improve wetting action.

A thin semi-permeable membrane, stretched over the sensor, isolates the electrodes from the environment, while allowing gases to enter. When a polarizing voltage is applied to the sensor electrodes oxygen that has passed through the membrane reacts at the cathode causing a current to flow.

The membrane passes oxygen at a rate proportional to the pressure difference across it. Since oxygen is rapidly consumed at the cathode, it can be assumed that the oxygen pressure inside the membrane is zero. Hence, the force causing the oxygen to diffuse through the membrane is proportional to the partial pressure of oxygen outside the membrane. As the oxygen partial pressure varies, so does the oxygen diffusion through the membrane. This causes the probe current to change proportionally.

## PREPARING THE PROBE

---

### MEMBRANE CAP INSTALLATION

The YSI 550A DO probe is shipped with a dry, protective membrane. Before using the instrument for the first time, remove the protective cap and replace it with a new one following these instructions:

1. Remove the probe sensor guard to access the probe tip.
2. Unscrew and remove the old membrane cap and discard.
3. Thoroughly rinse the sensor tip with distilled or DI water.
4. Fill a new membrane cap with O<sub>2</sub> probe solution that has been prepared according to the directions on the bottle. Be very careful not to touch the membrane surface. Lightly tap the side of the membrane cap to release bubbles that may be trapped.
5. Thread the membrane cap onto the probe. It is normal for a small amount of electrolyte to overflow.
6. Replace the probe sensor guard.

### MEMBRANE MAINTENANCE

Additional membrane changes will be required over time. The average replacement interval is 4 to 8 weeks, although they may last longer if kept clean. To clean the membrane, use a lint-free cloth, such as a Kimwipe, and rubbing alcohol to gently remove the contamination. In harsh environments, such as wastewater, membrane replacements may be required every 2 to 4 weeks.



# DISSOLVED OXYGEN CALIBRATION

---

Dissolved oxygen calibration must be done in an environment with known oxygen content. The YSI 550A DO Instrument can be calibrated in either mg/L or % saturation. Sections below include instructions on how to calibrate in either mode.

## BEFORE YOU CALIBRATE

To accurately calibrate the YSI 550A, you will need to know the following information:

- The approximate salinity of the water you will be analyzing. Fresh water has a salinity of approximately zero. Seawater has a salinity of approximately 35 parts per thousand (ppt). If you are uncertain what the salinity of the sample water is, use a YSI 30 Salinity-Conductivity-Temperature instrument to determine a salinity value.
- For calibration in % saturation mode, the approximate altitude (in feet) of the region where you are located is required. This information can be obtained over the internet or from a local airport or weather station. To convert from meters to feet, divide by 0.3048.

### For best results:

- Check calibration with each use and recalibrate as necessary to prevent drift. Dissolved oxygen readings are only as good as the calibration.
- Calibrate at a temperature within  $\pm 10^{\circ}\text{C}$  of the sample temperature.

## CALIBRATION IN % SATURATION

1. Ensure that the sponge inside the instrument's calibration chamber is moist. Insert the probe into the calibration chamber.
2. Turn the instrument on. Allow it to warm up and readings to stabilize for about 15-20 minutes.
3. Press and release both the **UP ARROW** and **DOWN ARROW** keys at the same time to enter the calibration menu.
4. Press the **Mode** key until “%” is displayed on the right side of the screen for oxygen units. Press **ENTER**.
5. The LCD will prompt you to enter the local altitude in hundreds of feet. Use the arrow keys to increase or decrease the altitude. When the proper altitude appears on the LCD, press the **ENTER** key.

**EXAMPLE:** Entering the number 12 here indicates 1200 feet.

6. **CAL** will now display in the lower left corner of the screen, the calibration value in the lower right corner and the current DO reading (before calibration) will be the main display. Once the current DO reading is stable, press the **ENTER** button.
7. The LCD will prompt you to enter the approximate salinity of the water you are about to analyze. You can enter any number from 0 to 70 parts per thousand (PPT) of salinity. Use the arrow keys to increase or decrease the salinity setting. When the correct salinity appears on the LCD, press the **ENTER** key. The instrument will return to normal operation.

## **CALIBRATION IN MG/L**

1. Turn the instrument on. Allow it to warm up and readings to stabilize for about 15-20 minutes.
2. Place the probe in a solution with a known mg/L reading. Continuously stir or move the probe through the sample at a rate of at least 1/2 foot per second (16cm per second) during the entire calibration process.
3. Press and release both the **UP ARROW** and **DOWN ARROW** keys at the same time to enter the calibration menu.
4. Press the **Mode** key until “mg/L” is displayed on the right side of the screen for oxygen units. Press **ENTER**.
5. **CAL** will now display in the lower left corner of the screen and the current DO reading (before calibration) will be on the main display. Once the current DO reading is stable, use the up and down arrow keys to select the mg/L value of the known solution, then press the **ENTER** button.
6. The LCD will prompt you to enter the approximate salinity of the water you are about to analyze. Enter any number from 0 to 70 parts per thousand (PPT) of salinity. Use the arrow keys to increase or decrease the salinity setting. When the correct salinity appears on the, press the **ENTER** key. The instrument will return to normal operation.

## **SALINITY COMPENSATION CALIBRATION**

---

1. Press the **Mode** key until salinity calibration is displayed on the screen.
2. Use the **UP ARROW** and **DOWN ARROW** keys to adjust the salinity value to that of the samples you will be measuring, 0-70 ppt.
3. Press the **ENTER** key to save the calibration.
4. Press **Mode** to return to dissolved oxygen measurement

# PROBE OPERATION

---

**NOTE:** The YSI 550A DO Instrument should not be used in a purpose other than that specified by YSI Incorporated. See **Warranty** for details.

## STIRRING

It is important to recognize that a very small amount of oxygen dissolved in the sample is consumed during probe operation. It is therefore essential that the sample be continuously stirred at the sensor tip. If stagnation occurs, measurements will appear artificially low.

Stirring may be accomplished by mechanically moving the sample around the probe tip, or by moving the probe through the sample. The YSI Model 550A has a flow dependence of <25%. The rate of stirring required is 1/2 foot per second (16cm per second).

## MEASUREMENT PROCEDURE

1. Insert the probe into the sample to be measured.
2. Continuously stir or move the probe through the sample.
3. Allow temperature and dissolved oxygen readings to stabilize.
4. Observe/Record readings.
5. If possible, rinse the probe with clean water after each use.

## PRECAUTIONS

1. Membranes last longer if properly installed and regularly maintained. Erratic readings can result from loose, wrinkled, damaged, or fouled membranes, large (more than 1/8" diameter) air bubbles in the electrolyte reservoir, or membrane coating by oxygen consuming (e.g. bacteria) or oxygen producing (e.g. algae) organisms. If unstable readings or membrane damage occurs, replace both the membrane cap and electrolyte solution.
2. Chlorine, sulfur dioxide, nitric oxide, and nitrous oxide can affect readings by behaving like oxygen at the probe.
3. Avoid substances such as acids, caustics, and strong solvents, which may damage probe materials. Probe materials include the PE membrane, acrylic plastic, EPR rubber, stainless steel, epoxy, polyetherimide and the PVC cable covering.
4. Always store the probe in the calibration/storage chamber with the moistened sponge.

# PROBE ELECTRODE MAINTENANCE

---

## SILVER ANODE

After extended use, a thick layer of AgCl builds up on the silver anode reducing the sensitivity of the sensor. The anode must be cleaned to remove this layer and restore proper performance. The cleaning can be chemical or mechanical:

- **Chemical cleaning:** Remove the membrane cap and rinse the electrodes deionized or distilled water. Soak the entire anode section in a 14% ammonium hydroxide solution for 2 to 3 minutes (or a 3% solution may be used and soaked overnight for 8-12 hours). Rinse heavily in cool tap water followed by a thorough rinsing with distilled or deionized water. The anode should then be thoroughly wiped with a wet paper towel to remove the residual layer from the anode.

**Warning: Chemical cleaning should be performed on an as-needed basis, and no more often than once a year (or once per six months in wastewater environments). When readings appear unstable or the instrument will not calibrate, first attempt a membrane change and recalibrate. If a new membrane does not resolve the problem, then proceed with the chemical cleaning.**

- **Mechanical cleaning:** Sand off the dark layer from the silver anode with 400 grit wet/dry sandpaper. Wrap the wet sandpaper around the anode and twist the probe. Rinse the anode with clean water after sanding, and wipe thoroughly with a wet paper towel.

## GOLD CATHODE

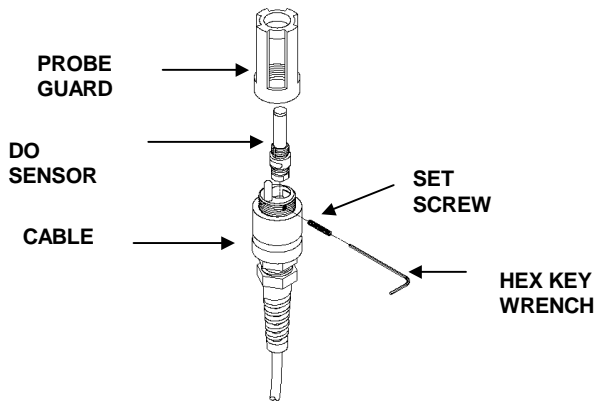
For correct probe operation, the gold cathode must be textured properly. It can become tarnished or plated with silver after extended use. The gold cathode can be cleaned by using the YSI 5238 Probe Reconditioning Kit or 400 grit wet/dry sandpaper. Never use chemicals or abrasives not recommended or supplied by YSI.

Using the sanding paper provided in the YSI 5238 Probe Reconditioning Kit, wet sand the gold with a twisting motion about 3 times or until all silver deposits are removed and the gold appears to have a matte finish. If the cathode remains tarnished, return the probe for service. Wipe the gold cathode thoroughly with a wet paper towel before putting on a new membrane cap.

## REPLACEMENT OF THE DO ELECTRODES

Should replacement of the DO Electrodes be required, the user may purchase a YSI 559 Replaceable DO Module Kit. The kit includes an instruction sheet, DO sensor module, set screw, and hex key wrench.

1. Remove probe guard.
2. **IMPORTANT:** Thoroughly dry the sensor so that no water enters the probe port when the sensor is removed.
3. Insert the long end of the hex key wrench into the small hole in the side of the DO sensor. Turn the wrench counter clockwise until the sensor is released.
4. Pull the DO sensor out of the probe.



5. Make sure that the inside of the connector and the o-ring of the sensor are clean and dry, with no contaminants, such as grease, dirt, or hair. Insert the new sensor.
6. Use the hex key wrench to tighten the screw, making sure that the screw does not stick out on either side of the DO sensor module. Also, if the hex screw was removed completely, make sure that it is not cross-threaded when replaced.
7. The YSI 559 DO module is shipped with a dry, protective membrane. Before using for the first time, remove the protective cap and replace it with a new one following the instructions for **Membrane Cap Installation**.

## ACCESSORIES/REPLACEMENT PARTS

The following parts and accessories are available from YSI or any YSI Authorized Dealer.

YSI Model Number	Description
5908	Membrane Kit, 1.25 mil PE, 6 caps and bottle of electrolyte solution
559	Replaceable DO Module
5238	Probe Reconditioning Kit, 10 sanding discs (400 grit) and sanding tool
5065	Form-Fitted Cover with Shoulder Strap
614	Ultra Clamp, C-Clamp Mount
4654	Tripod
5085	Hands Free Harness
5050	Small, Hard-sided Carrying Case, Foam-lined
5060	Small, Soft-sided Carrying Case, Precut Foam Interior
5080	Small, Hard-sided, Pelican Carrying Case, Precut Foam Interior

# SPECIFICATIONS

Display	Resolution	Range	Accuracy
Dissolved O <sub>2</sub> mg/L	0.01 mg/L or 0.1 mg/L, user selectable	0 to 20 mg/L	± 0.3 mg/L or ± 2% of reading, whichever is greater
		20 to 50 mg/L	± 6% of reading
Dissolved O <sub>2</sub> %	0.1% or 1%, user selectable	0 to 200%	± 2% air sat or ± 2% of reading, whichever is greater
		200 to 500%	± 6% of reading
Temperature °C	0.1 °C	-5 to +45 °C	± 0.3 °C
Temperature °F	0.1 °F	23 to 113 °F	± 0.6 °F

<b>Medium:</b>	Fresh, sea or polluted water
<b>Dissolved Oxygen Sensor:</b>	Steady-state polarographic
<b>Dissolved Oxygen Probe:</b>	Field-replaceable module
<b>Dissolved Oxygen Response Time:</b>	95% of end value in 9 seconds
<b>Temperature Units:</b>	Celsius or Fahrenheit, user selectable
<b>Parameter Compensation:</b>	Automatic temperature compensation for dissolved oxygen Automatic salinity compensation (0-70 ppt) for dissolved oxygen Altitude compensation for dissolved oxygen percent calibration
<b>Size:</b>	4.7 in. width; 9 in. length (11.9 cm x 22.9 cm)
<b>Weight with Batteries:</b>	2 lb. (0.91 kg)
<b>Power:</b>	4 alkaline C-cells
<b>Battery life:</b>	Over 2000 hours at 25°C (77°F)
<b>Cables:</b>	12, 25, 50, and 100-foot lengths (3.5, 7.5, 15, 30.5 meter lengths)
<b>Other Features:</b>	Waterproof to IP-67 High-impact resistance Push-button calibration Built-in calibration chamber Large back-lit display Low battery indicator on display Manual salinity input CE-compliance

# TROUBLESHOOTING

**NOTE: An error displayed briefly during the first few seconds after turning the instrument on does NOT indicate a problem.**

<b>SYMPTOM</b>	<b>POSSIBLE SOLUTION</b>
1. Instrument will not turn on, LCD displays "LO BAT", or Main display flashes "OFF"	A. Low battery voltage, replace batteries B. Batteries installed incorrectly, check battery polarity C. Return system for service
2. Instrument will not calibrate.	A. Replace membrane and electrolyte B. Clean probe electrodes C. Return system for service
3. Instrument "locks up".	A. Remove batteries, wait 15 seconds for reset, replace batteries B. Replace batteries C. Return system for service
4. Instrument readings are inaccurate.	A. Verify calibration altitude and salinity settings are correct and recalibrate. B. Probe may not have been in 100% water saturated air during calibration procedure. Moisten sponge in calibration chamber and recalibrate. C. Replace membrane and electrolyte. Recalibrate. D. Clean probe electrodes. E. Return system for service.
5. Main display reads "Over" or "Undr".	A. Sample O <sub>2</sub> concentration is more than 60 mg/L or 500%, or less than -0.02 mg/L or -0.3%. B. Verify calibration altitude and salinity settings are correct and recalibrate. C. Replace membrane and electrolyte. Recalibrate. D. Clean probe electrodes. E. Return system for service.
6. Main display reads "Over" or "Undr" during calibration.	A. Replace membrane and electrolyte. Recalibrate. B. Clean probe electrodes. C. Return system for service.

<b>SYMPTOM</b>	<b>POSSIBLE SOLUTION</b>
7. Secondary display reads "Ovr" or "Undr".	<p>A. Sample temperature is less than -5° C (23°F) or more than +45°C (122°F). Increase or decrease the sample temperature to bring within the allowable range.</p> <p>B. Return system for service.</p>
8. Main display reads "Err" and Secondary display reads "RO", "RA", or "AdC".	A. Return system for service
9. Main display reads "Err" or "burn" and Secondary display reads "EEP"	A. Return system for service

## CONTACT INFORMATION

---

YSI offers a wide range of customer assistance and technical support functions to ensure that you have the information required to use our products. Contact YSI if you need assistance or have questions regarding any YSI Product. Business hours are Monday through Friday, 8AM to 5PM ET.

YSI Environmental Incorporated  
 1725 Brannum Lane  
 Yellow Springs, OH 45387  
 Toll Free: 800-897-4151 (US)  
 Phone: +1 937 767-7241  
 Fax: +1 937 767-1058  
 E-Mail: [environmental@ysi.com](mailto:environmental@ysi.com)  
[www.ysi.com](http://www.ysi.com)



## REQUIRED NOTICE

The Federal Communications Commission defines this product as a computing device and requires the following notice:

This equipment generates and uses radio frequency energy and if not installed and used properly, may cause interference to radio and television reception. There is no guarantee that interference will not occur in a particular installation. If this equipment does cause interference to radio or television reception, which can be determined by turning the equipment off and on, the user is encouraged to try to correct the interference by one or more of the following measures:

- re-orient the receiving antenna
- relocate the YSI Instrument with respect to the receiver
- move the YSI Instrument away from the receiver
- plug the YSI Instrument into a different outlet so that the computer and receiver are on different branch circuits.

If necessary, the user should consult the dealer or an experienced radio/television technician for additional suggestions. The user may find the following booklet, prepared by the Federal Communications Commission, helpful: "How to Identify and Resolve Radio-TV Interference Problems." This booklet is available from the U.S. Government Printing Office, Washington, DC 20402, Stock No. 0004-000-00345-4.

**Note:** While testing to EN-61000-4-6, Conducted RF Immunity, per Table A.1 of EN61326, Electrical Equipment for Measurement, Control and Laboratory Use, the YSI 550A exhibited an ERROR 8 message from 8.6 MHz 22.8 MHz at induced RF voltages of 3-Volts to 1-Volt RMS on the 25-foot probe cable. If you observe this interference please relocate the probe-cable away from heavy industrial equipment power and control cables or communications equipment cables which may be causing the interference.



**STANDARD OPERATING PROCEDURE**  
**MAINE VOLUNTEER RIVER MONITORING PROGRAM**  
**METHODS FOR USING THE YSI DO200 HANDHELD**  
**METER IN RIVERS AND STREAMS**



**Note:** The mention of brand names does not constitute recommendation of a specific company.



## Volunteer River Monitoring Program

### Standard Operating Procedure Methods for using the YSI DO200 Handheld Meter

**1. Applicability.** This standard operating procedure (SOP) is used by the Volunteer River Monitoring Program (VRMP) of the Maine Department of Environmental Protection's (DEP's) Bureau of Water Quality, Division of Environmental Assessment, Watershed Management Unit. It applies to the collection of dissolved oxygen (DO) and temperature from rivers and streams in Maine using an YSI DO200 handheld meter.

**2. Purpose.** The purpose of this SOP is to provide standardized methods for volunteer groups to determine temperature and dissolved oxygen (DO) of rivers and streams as an instantaneous reading using the YSI DO200 handheld meter.

### 3. Definitions.

**A. YSI.** Yellow Springs International, manufacturer of water quality monitoring meters.

**B. Probe.** Sensing device located at the end of a cable that is attached to the meter.

**C. KCl solution.** Potassium Chloride solution used to fill the probe, also referred to as Oxygen Probe solution

**D. Calibration.** Set of procedures established by the manufacturer to ensure that the meter is operating properly; a critical quality assurance step in meter preparation prior to use.

**E. Membrane.** A clear, transparent and paper-thin substance similar to cellophane on the end of the probe. The membrane is permeable and allows gases such as oxygen to pass through into probe sensors while at the same time isolating most other undesirable substances.

**F. Jigging.** To move the probe under water using steady movements. Unless the probe is being held in swiftly flowing water, the probe shall be moved ("jigged") approximately 1/2 ft per second to overcome the inherent consumption of oxygen by the sensor.



## 4. Responsibilities.

### A. *Volunteer Monitors & Volunteer Groups*

- **Certification.** It is the responsibility of the individual obtaining this data to maintain current certification for the parameter(s) they collect if they wish their data to be entered into the VRMP database. Training will be provided to volunteers on an annual basis by VRMP/DEP staff, and certification will last for one year from the date of training.
- **Data Recording.** It is the responsibility of the individual obtaining this data to record the results and additional qualifying information on current VRMP field sheets obtained from their affiliated watershed association or through the VRMP program of the DEP.
- **Data Quality Checks and Data Submission.** The data manager for the volunteer group will collect and enter volunteer field sheet data into the appropriate computer file, perform quality assurance checks (Refer to Section 5.10 of the Quality Assurance Program Plan), and submit data to the VRMP following protocols outlined in the volunteer group's latest sampling and analysis plan (SAP) that has been approved by the VRMP.

### B. *Volunteer River Monitoring Program (VRMP) Staff*

- **Oversight of Volunteer Groups and Volunteers.** VRMP staff will oversee volunteer groups and volunteers through a variety of ways including maintaining an up-to-date VRMP quality assurance program plan (QAPP); reviewing sampling and analysis plans (SAPs) of the volunteer groups; providing annual training/certification sessions for volunteers; conducting quality assurance checks on data submitted by volunteer groups and laboratories; and uploading data into the DEP's EGAD (Environmental and Geographic Analysis Database) database. These tasks are described in greater detail in the VRMP's latest QAPP.

## 5. Guidelines and Procedures.

### A. *YSI DO200 Meter Preparation.*

- **First time use.** Follow manufacturer's instructions for preparing meter for first time use. (Refer to Appendix A; sections "General Introduction", "Initial Inspection", "Precautions", "Probe Preparation", and "Battery Installation"; pgs. 2 – 3).
- **Beginning of field season.** Before each field season, volunteer monitoring groups shall conduct a full inspection of the meter. If membrane has been stored dry, follow manufacturer's instructions for first-time use (see above). A new membrane cap and



batteries shall be installed on the probe at the start of the sampling season and additionally, as needed.

Each meter “setup” should be equipped with the following items so that field repairs can be undertaken as necessary:

- Extra KCL fluid and membrane caps for probe
  - Extra batteries
  - Field data sheet
  - Screwdriver for removing back of meter to replace batteries
  - Pencil with eraser
- **Prior to field sampling.** Before each field sample collection, the volunteer shall inspect the meter including an inspection of the condition of the probe membrane or membrane cap and batteries.
    - (1) Check the membrane for air bubbles and wrinkles. If bubbles or wrinkles are present, remove membrane cap, refill with KCL solution and replace membrane cap.
    - (2) Check to make sure no drops of water are clinging to the membrane. If drops are present, blow on membrane to gently remove droplets. Don't tap; these probes are very fragile. Replace probe into the calibration bottle.
    - (3) Batteries should be checked and meter should be calibrated according to manufacturer's instructions (see next paragraph).
    - (4) Power on the meter and allow sufficient warm-up time (20 min) prior to initial use for the day.
  - **Dissolved Oxygen Calibration.** The YSI DO200 meter shall be calibrated each time the unit is turned on. Meters shall be calibrated to a 100% water-saturated air environment. (For instructions, refer to Appendix A, section “Calibration Set-Up”, pgs. 4-5).
  - **Dissolved Oxygen Check Against “Zero Dissolved Oxygen” Standard.** Volunteers shall check their DO meter using zero oxygen solution at least once a month, typically at the beginning of the month. The zero oxygen solution can be obtained from VRMP/DEP staff as needed. Volunteers shall record the dissolved oxygen value they measure with their meter in the appropriate blank on the field data sheet. (See section 5-B of this SOP for instructions on how to make measurements with the YSI DO200 meter.)

### ***B. Dissolved Oxygen/Temperature Measurements.***

- **Sampling Period and Location.** Sampling period and site location information will be documented in the volunteer groups' SAPs (that require approval by the VRMP) which are submitted by the volunteer groups prior to the beginning of a sampling season. (Detailed information regarding how volunteer groups are to obtain and document site location information can be found in VRMP SOP-02 [Documenting Site Location].)



- **Sample Timing.** Dissolved oxygen data collected between dawn and 8 am are important for assessment of attainment of DO criteria within Maine’s Water Quality Standards. But, except as naturally occurs, DO concentrations below the applicable DO criteria at any time of day signal non-attainment. If there are no DO concentrations below the criteria after 8 am, then data between dawn and 8 am must be collected to assess attainment of the criteria.
- **Familiarize Yourself with the Meter.** Familiarize yourself with the basic operation, keypad, and readouts of the meter (Appendix A; sections “The Keypad”, “The LCD Display”, “Operational Procedures”, and “Measurement Modes”; pgs. 3-4.)
- **General Sampling Protocol.**
  - Record site location on data sheet.
  - Remove probe from calibration bottle.
  - Submerge probe in the water at the site where you are monitoring, as described in your group’s approved SAP.
  - Allow the dissolved oxygen (DO) reading to stabilize (at least 15 seconds) before recording the value on the field sheet.
  - Follow the instructions specific to measuring DO and temperature below.
  - The meter should remain turned on between stations, unless time between samplings exceeds 30-60 minutes. If meter is turned off, the field probe should be stored inside the calibration chamber during transport, sufficient time (20 min) should be allowed for warm-up, and the meter should be re-calibrated.
- **Dissolved Oxygen Measurements**
  - (1) Review and follow the instructions for making DO measurements in section “Operational Procedures” and “Measurement Modes” (Appendix A, pg. 4). Make sure units are taken in mg/L (or ppm).
  - (2) *Note of caution:* Unless the probe is equipped with a stirrer, jiggling of the probe is extremely important for obtaining accurate dissolved oxygen readings, unless you have placed the probe in a swiftly-moving section of stream or river. (The probe is dependent on the amount of oxygen that passes across the membrane, and the probe actually consumes oxygen as it is making measurements.) An up-and-down motion (jiggling) creating movement of 1/2 ft per second is recommended.
- **Temperature Measurements.**
  - (1) Review and follow the instructions for making temperature measurements in Section “Operational Procedures” and “Measurement Modes” (Appendix A, pg. 4).
- **Quality Control**
  - (1) At the beginning of each field season, all VRMP staff and VRMP volunteers who will collect dissolved oxygen and temperature data will have a



training/refresher/certification session to (re)familiarize themselves with the contents of this SOP.

(2) For every volunteer, a field duplicate shall be obtained for all parameters for at least 10% of their own sampling efforts. A field duplicate will be collected for every 10 samples monitored.

(3) Refer to the VRMP quality assurance project plan (QAPP) for more QA/QC details.

## **6. Equipment Care.**

### ***A. Start of field season.***

1. Follow manufacturer's directions for preparation of a new probe or renewing probe in the spring (refer to Appendix A; section "Probe Preparation", pg. 3).
2. Use new batteries at start of each sampling season. An extra set of appropriate size batteries should be included in the meter carrying case.
3. Each D.O. meter should have the following items for making repairs in the field. See item 5-A (under "Beginning of field season") for details.

### ***B. Field Season***

1. Ideally the meter should be in water-resistant case with padding to protect it from damage.
2. Always store the probe in the calibration/storage bottle with a small wet sponge to keep the electrolyte from drying out and the membrane cap from being damaged.
3. Allow the case and contents to air-dry at end of each day. This may be accomplished by simply propping the protective case's lid open. When contents are very wet, remove the contents and spread out to facilitate drying.
4. Keep meter from freezing.
5. Refer to Appendix A (sections "Precautions" {pgs, 2-3} and "Probe Maintenance" {pg. 5}) for manufacturer's recommendations for maintenance requirements.

### ***C. End of field season***

1. Completely dry meter and case and all items in the case before storing.
2. Remove batteries.
3. Remove membrane cap.
4. Rinse entire probe and probe chamber with distilled water.
5. Cover top of probe to keep dust and dirt out for winter.
6. Keep meter dry and at room temperature to prevent corrosion of electronic parts.
7. Review Appendix A (sections "Precautions" {pgs, 2-3} and "Probe Maintenance" {pg. 5}) for more tips.
8. Record winterization date and equipment repairs in your volunteer group's Equipment Log.



9. Label the meter and case as ‘WINTERIZED’ in an obvious manner (so users will know the current status of the unit).

## 7. Specifications

Display	Range	Accuracy	Resolution
Dissolved Oxygen (ppm or mg/L)	0 to 20.00 ppm (mg/L)	±2% of the reading or ± 2% air saturation, whichever is greater	0.01 mg/L
Dissolved Oxygen %	0 to 200.0 %	±2% of the reading or ±0.2 ppm, whichever is greater	0.1 %
Temperature (°C)	-6.0 to 46.0 °C	±0.3 °C ± 1 digit	0.1 °C

## 8. Appendix

### A. Dissolved Oxygen Meter owner’s manual:

YSI Incorporated. 2004. Operations Manual: YSI EcoSense® DO200 Field/Lab Dissolved Oxygen and Temperature Instrument. Yellow Springs, Ohio.

## 9. References.

### A. DEP Standard Operating Procedures:

- Document number #:DEP-LW0890: Dissolved Oxygen and Temperature, Instantaneous Measurement using Electronic Meters

### B. Maine VRMP QAPP:

- Maine Department of Environmental Protection (MDEP). 2020. Maine Volunteer River Monitoring Program (VRMP) Quality Assurance Program Plan (QAPP). Portland, ME. DEPLW-0984.





YSI Environmental

# Operations Manual YSI EcoSense® DO200

**Field/Lab  
Dissolved Oxygen  
and Temperature  
Instrument**



- English
- Français
- Español
- Deutsch
- Italiano

Pure  
Data for a  
Healthy  
Planet.®

## **WARRANTY**

The YSI DO200 Instrument is warranted for one year from date of purchase by the end user against defects in materials and workmanship. YSI DO200 probes and cables are warranted for one year from date of purchase by the end user against defects in material and workmanship. Within the warranty period, YSI will repair or replace, at its sole discretion, free of charge, any product that YSI determines to be covered by this warranty.

To exercise this warranty, write or call your local YSI representative, or contact YSI Customer Service in Yellow Springs, Ohio. Send the product and proof of purchase, transportation prepaid, to the Authorized Service Center selected by YSI. Repair or replacement will be made and the product returned, transportation prepaid. Repaired or replaced products are warranted for the balance of the original warranty period, or at least 90 days from date of repair or replacement.

### **Limitation of Warranty**

This Warranty does not apply to any YSI product damage or failure caused by: (i) failure to install, operate or use the product in accordance with YSI's written instructions; (ii) abuse or misuse of the product; (iii) failure to maintain the product in accordance with YSI's written instructions or standard industry procedure; (iv) any improper repairs to the product; (v) use by you of defective or improper components or parts in servicing or repairing the product; or (vi) modification of the product in any way not expressly authorized by YSI.

THIS WARRANTY IS IN LIEU OF ALL OTHER WARRANTIES, EXPRESSED OR IMPLIED, INCLUDING ANY WARRANTY OF MERCHANTABILITY OR FITNESS FOR A PARTICULAR PURPOSE. YSI's LIABILITY UNDER THIS WARRANTY IS LIMITED TO REPAIR OR REPLACEMENT OF THE PRODUCT, AND THIS SHALL BE YOUR SOLE AND EXCLUSIVE REMEDY FOR ANY DEFECTIVE PRODUCT COVERED BY THIS WARRANTY. IN NO EVENT SHALL YSI BE LIABLE FOR ANY SPECIAL, INDIRECT, INCIDENTAL OR CONSEQUENTIAL DAMAGES RESULTING FROM ANY DEFECTIVE PRODUCT COVERED BY THIS WARRANTY.

## **CONTACT INFORMATION**

YSI Environmental, Inc. • 1725 Brannum Lane • Yellow Springs OH, 45387  
800-897-4151 • 937-767-7241 • Fax: 937-767-1058  
Email: [environmental@ysi.com](mailto:environmental@ysi.com) • Website: [www.ysi.com/environmental](http://www.ysi.com/environmental)

## CONTENTS

GENERAL INTRODUCTION.....	2
INITIAL INSPECTION .....	2
PRECAUTIONS .....	2
The Case .....	2
The Probe .....	2
PROBE PREPARATION.....	3
BATTERY INSTALLATION .....	3
THE KEYPAD.....	3
THE LCD DISPLAY .....	4
OPERATIONAL PROCEDURES .....	4
MEASUREMENT MODES .....	4
CALIBRATION SET-UP .....	4
Requirements.....	4
Procedure .....	5
PROBE MAINTENANCE.....	5
TROUBLESHOOTING .....	6
SPECIFICATIONS .....	6
CONVERSIONS.....	6
RECOMMENDED SPARE PARTS LIST .....	6

## **GENERAL INTRODUCTION**

The YSI DO200 is one of three instruments in the EcoSense® product line from YSI. The DO200 is a precise tool that measures dissolved oxygen in % and ppm (mg/L) and temperature. A built-in microprocessor stores, calculates, and compensates for all parameters related to DO determinations including DO electrode temperature characteristics.

This unit has a splash-resistant IP65 case. The mechanical touch keys are highly reliable with tactile and audio feedback. This instrument uses one 9V battery. Re-calibration is not required when power is restored.

The front of the instrument has a large LCD that displays DO %, ppm, and temperature simultaneously along with user prompts and mode indicators. The unit prompts the user through calibration and measurement procedures.

The model DO200 field and lab probes use a polarographic electrode with convenient screw-on cap membranes. The 200-4 and 200-10 field probes come with a built-in temperature probe for automatic temperature compensation, as well as a stainless steel body for added weight. The 200-BOD lab probe comes with a power supply and includes self-stirring and replaceable electrodes.

Other features include long battery life and high 50/60 Hz AC noise rejection. This instrument is universal and user-friendly for field, industrial, and laboratory applications.

## **INITIAL INSPECTION**

Carefully unpack the unit and accessories, and inspect for shipping damages. Compare received parts with materials listed on the packing list. Notify YSI immediately of any damage or missing parts. Save all packing materials until satisfactory operation is confirmed.

## **PRECAUTIONS**

### **The Case**

Though the DO200 instrument is housed in a splash-proof IP65 case, DO NOT use it underwater; the connector is not waterproof. The splash-resistant case prevents permanent damage to the unit if accidentally sprayed with non-corrosive solutions. In case of submersion, follow these steps immediately:

1. Dry the connector if necessary, and replace the DO probe. Rinse unit carefully with distilled water. After rinsing and drying, inspect and clean connectors to remove all contaminants that may affect probe connections.
2. Wait for unit and probe to dry completely before resuming operation.
3. If the unit does not function correctly after steps 1 and 2, call YSI for possible repair or replacement (see Warranty).

### **The Probes (Field & Lab)**

1. Membranes last longer if properly installed and regularly maintained. Erratic readings can result from damaged or fouled membranes or from large bubbles in the electrolyte reservoir. If unstable readings or membrane damage occurs, replace both the membrane cap and Oxygen Probe solution (also known as "O<sub>2</sub> Probe Electrolyte", potassium chloride, or KCl solution). The average replacement interval is 4 to 8 weeks, although they may last longer if kept clean. Harsh environments, such as wastewater, may require membrane replacement every 2 to 4 weeks. Unstable readings may occur if membrane cap is coated with oxygen consuming or oxygen evolving organisms such as bacteria or algae.
2. Chlorine, sulfur dioxide, nitric oxide and nitrous oxide can affect readings by behaving like oxygen at the probe.
3. Avoid substances that may damage probe materials such as concentrated acid, caustics and strong solvents. Probe materials include Stainless steel, epoxy and ABS Plastic.

4. Keep the probe's gold cathode clean and textured (when properly maintained it has a matte finish). If it is tarnished (from contact with certain gases), or plated with silver (from extended use with a loose or wrinkled membrane), then clean it, following the instructions in "Probe Maintenance".
5. To prevent the membrane and electrolyte from drying out, store the field probe in the calibration bottle with the moistened sponge and the lab probe in a BOD bottle with 1 inch of water to keep them in a saturated air environment.

## **PROBE PREPARATION**

The YSI DO200 probe ships with a dry, protective membrane. To install a new membrane cap on the probe:

1. Unscrew probe membrane cap and discard.
2. Fill a new cap with Oxygen Probe Solution. Prepare according to directions on the solution bottle.
3. Thread filled membrane cap onto sensor.
4. Allow sufficient warm-up time for initial use (10-15 min). During this time an "ovEr" message may appear on the display. This is normal. After the warm up is complete the message will disappear.

## **BATTERY INSTALLATION**

An initial display of "LOW BAT" on the LCD indicates approximately one hour of battery life for unit operation within specifications. Replace battery when "LOW BAT" appears on the LCD.

To replace battery, remove the two battery cover screws and the battery cover and o-ring. Replace the 9V battery. Replace the battery cover and o-ring (be sure to align the o-ring correctly to prevent a bad

seal) and fasten the two battery cover screws for the splash-resistant feature.

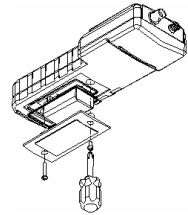




Figure 1.  
Battery Installation

## **THE KEYPAD**

1. : Turns the unit on or off.
2. **MODE**: In normal operation, toggles display between Dissolved Oxygen in % air saturation and Dissolved Oxygen in ppm (mg/L). In Calibration mode, exits current calibration and displays the next calibration parameter.
3. **CAL**: In normal operation, changes the mode from Normal to Calibration. See Calibration Set-up.
4. : In Calibration Set-up, press this key to save the current parameter to memory.
5. **Δ and ∇ Keys**: Increases or decreases the display value as desired.

## THE LCD DISPLAY

1. **BAT:** Low battery indicator.
2. **CAL:** Calibration mode indicator.
3. **SAL ppt:** Displays during calibration when user is prompted for the approximate salinity of the sample in parts per thousand (ppt).
4. **mBar:** Displays during calibration to prompt user for barometric pressure.
5. Main display for dissolved oxygen values.
6. **%/ppm:** Unit indicators.
7. **°C:** Temperature display.

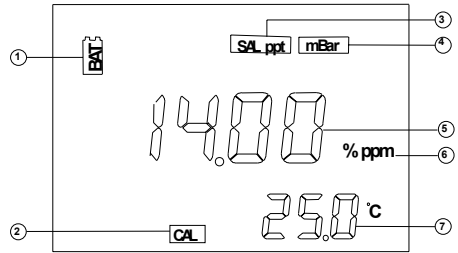


Figure2. LCD Display

## OPERATIONAL PROCEDURES

Press **⏻** to turn the unit on or off. The instrument will perform a self-diagnostic test, during which an “ovEr” message may appear on the display. This is normal. After the warm up is complete the message will disappear. After the self-diagnostic test completes, the temperature displays in the lower right of the display, and the unit is ready for operation. Immerse the probe halfway into the sample solution. If possible, do not allow probe to touch any solid object in the solution. Allow no air bubbles around the probe. When the unit is not in use, turn it off to save battery life.

**NOTE:** During an oxygen measurement, the probe must be moved approximately 1/2 ft per second to overcome the inherent consumption of oxygen by the sensor. When using the 200-BOD lab probe, however, simply use the probes self-stirring feature.

## MEASUREMENT MODES

This unit provides three distinct measurements:

1. **Temperature** - Current solution temperature continually displays.
2. **Dissolved Oxygen %** - Measurement of oxygen in percent saturation.
3. **Dissolved Oxygen ppm** - Measurement of oxygen in ppm (mg/L).

Carefully observe the units displayed at the far side of the LCD to determine the desired mode.

## CALIBRATION SET-UP





### **Requirements**

1. The approximate pressure (in millibars [mBar]) of the region to be measured for dissolved oxygen.
2. The approximate salinity of the water to be analyzed. Fresh water has an approximate salinity of zero. Seawater has an approximate salinity of 35 parts per thousand (ppt).
3. For highest accuracy, complete all calibrations at a temperature as close as possible to the sample temperature.

## Procedure

1. For the field probe, place 5-6 drops of clean water (tap, distilled, or deionized) into the sponge inside the calibration bottle. Turn the bottle over and allow any excess water to drain out of the bottle. The wet sponge creates a 100% water-saturated air environment for the probe, which is ideal for calibration, transport, and storage of the Model DO200 probe. For calibration, the probe remains in a water saturated air atmosphere and is not submersed.

For the lab probe, simply use the same bottle the probe is stored in with approximately 1 inch of water in the bottom. This creates a 100% water-saturated air environment for the probe, which is ideal for calibration and storage of the Model 200-BOD probe. For calibration, the probe remains in a water saturated air atmosphere and is not submersed.

2. For the field probe, slide it into the calibration bottle. Be sure the membrane does not touch the sponge.
3. Turn on the DO200 by pressing . Wait 10 to 15 minutes for the dissolved oxygen and temperature readings to stabilize.
4. Press **CAL**.
5. The LCD prompts for the local pressure in mBar. Use the **Δ** and **∇** keys to increase or decrease the pressure value respectively. See the section titled 'Conversions' to convert barometric pressure units to mBars.
6. When the proper pressure displays, press  once to view the calibration value in the lower right of the display. Once the value in the main display stabilizes, press  again to move to the salinity compensation procedure.
7. The display prompts for the approximate salinity of the water to be analyzed. Use the **Δ** and **∇** keys to increase or decrease the salinity compensation value to the value of your sample (between 0 to 40 parts per thousand [ppt]). When the correct salinity displays, press .
8. The unit holds calibration even if it is powered off. However, it is recommended to check calibration with each use and recalibrate as necessary to prevent drift. Dissolved oxygen readings are only as good as the calibration.

## PROBE MAINTENANCE

To clean the probes, use the YSI Probe Reconditioning kit (part number 5238) for the field probe. For the lab probe, use the sanding disc included in the 5908 membrane kit and follow the cleaning instructions outlined in the 200-BOD probe manual in regards to sanding. In addition to the Reconditioning Kit and sanding disc with your 5908 membrane kit, you may try a chemical cleaning. To clean the electrodes chemically, perform an ammonium hydroxide soak.

1. Remove membrane cap and rinse the probe with clean water (tap, distilled, or deionized).
2. Turn unit off, or disconnect probe.
3. Obtain either:
  - 14 % lab strength ammonium hydroxide and soak for 2-3 minutes
  - 3% household cleaning strength ammonia and soak overnight (8-12 hours)
4. Rinse ammonium hydroxide/ammonia from probe.
5. Use sandpaper (400 grit wet/dry, supplied with 5238 kit and with the 5908 membrane kit) to buff (wet sand) excess deposits from probe.
6. Install a new membrane cap.

Never use chemicals or abrasives not recommended by YSI.

## **TROUBLESHOOTING**

<b>Main Display reads:</b>	<b>Possible Solutions:</b>
“ovEr” or “undr”	<ul style="list-style-type: none"> <li>• Check membrane and electrolyte solution.</li> <li>• Clean anode and cathode.</li> <li>• Return product for service.</li> </ul>
<b>Secondary Display reads:</b>	<b>Possible Solutions:</b>
“undr”	<ul style="list-style-type: none"> <li>• Heat the sample to above –6.0 °C</li> <li>• Return product for service.</li> </ul>
“ovEr”	<ul style="list-style-type: none"> <li>• Cool sample to below 46.0 °C</li> <li>• Return product for service.</li> </ul>

## **SPECIFICATIONS**

<b>Display</b>	<b>Range</b>	<b>Accuracy</b>	<b>Resolution</b>
Dissolved O <sub>2</sub> (ppm or mg/L)	0 to 20.00 ppm (mg/L)	±2 % of the reading or ±2% air saturation, whichever is greater	0.01 mg/L
Dissolved O <sub>2</sub> % air-sat	0 to 200.0 %	±2% of the reading or ±0.2 ppm, whichever is greater.	0.1 %
Temperature °C	-6.0 to 46.0 °C 21 to 115 °F	±0.3 °C ±1 digit	0.1 °C

<b>Pressure Compensation</b>	600 to 1100 mBar (450 to 825 mmHg)
<b>Salinity Compensation</b>	From 0.0 to 40.0 ppt
<b>ATC Probe</b>	Thermistor, 10KΩ, at 25°C
<b>Calibration Backup</b>	Yes
<b>Audio Feedback</b>	Yes, on all keys
<b>Power Source</b>	One 9V battery
<b>Operating Temperature</b>	0 to 50°C (32 to 122 °F)
<b>Instrument Casing</b>	Splash-resistant IP 65
<b>Weight (with battery)</b>	350 grams (.75 lbs)
<b>Dimensions (L x W x D)</b>	186 mm x 70 mm x 37 mm (7.3 in x 2.8 in x 1.5 in)

## **CONVERSIONS**

<b>To Convert:</b>	<b>Multiply by:</b>
Inches of Hg to mBar	33.864
Inches of Hg to mmHg	25.4
mmHg to mBar	1.333

## **RECOMMENDED SPARE PARTS LIST**

<b>PART #</b>	<b>DESCRIPTION</b>
200-4	4 meter (approx. 13 feet) probe and cable assembly
200-10	10 meter (approx. 33 feet) probe and cable assembly
200-BOD	Self-stirring BOD lab probe and cable assembly with power supply
280	DO carrying case, hard sided
5908	Membrane kit, 1.25 mil PE (605306), six cap membranes and KCl solution
480	Instrument carrying case, soft



## **GARANTIE**

L'appareil YSI DO200 est garanti pour une période d'un an, à compter de la date d'achat par l'utilisateur final, contre tout défaut matériel et de fabrication. Les sondes et les câbles de l'YSI DO200 sont garantis pour une période d'un an, à compter de la date d'achat par l'utilisateur final, contre tout défaut matériel et de fabrication. Pendant la période de garantie, YSI s'engage à réparer ou à remplacer, gratuitement et à sa discrétion, tout produit qu'YSI peut établir comme étant couvert par la garantie.

Pour faire valoir cette garantie, écrivez ou appelez votre représentant YSI ou contactez le Service clientèle d'YSI à Yellow Springs, Ohio, États-Unis. Envoyez le produit et son justificatif d'achat en port payé au Centre de service homologué sélectionné par YSI. La réparation ou le remplacement seront effectués et le produit vous sera retourné en port payé. Les produits réparés ou remplacés sont garantis jusqu'à expiration de la période de garantie originale ou au moins 90 jours à compter de la date de réparation ou de remplacement.

### **Limitation de garantie**

Cette garantie ne s'applique pas aux produits YSI endommagés ou présentant des dysfonctionnements pour les raisons suivantes : (i) installation, exploitation ou utilisation du produit d'une façon non conforme aux instructions écrites d'YSI ; (ii) abus ou mésusage du produit ; (iii) manquement à l'entretien du produit conformément aux instructions écrites d'YSI ou aux procédures industrielles normales ; (iv) réparation non conforme du produit ; (v) utilisation par vous de pièces ou de composants défectueux ou non conformes lors de l'entretien ou de la réparation du produit ; ou, (vi) modification du produit d'une façon non expressément autorisée par YSI.

CETTE GARANTIE REMPLACE TOUTES LES AUTRES GARANTIES, EXPRESSES OU INDUITES, Y COMPRIS LES GARANTIES DE COMMERCIALISABILITÉ OU D'ADAPTATION À UN USAGE PARTICULIER. LA RESPONSABILITÉ D'YSI SELON LES TERMES DE CETTE GARANTIE SE LIMITE À LA RÉPARATION OU AU REMPLACEMENT DU PRODUIT, CONSTITUANT VOTRE SEUL ET UNIQUE RECOURS POUR TOUT PRODUIT DÉFECTUEUX COUVERT PAR CETTE GARANTIE. YSI NE POURRA EN AUCUN CAS ÊTRE TENU RESPONSABLE DE DOMMAGES SPÉCIAUX, INDIRECTS, ACCIDENTELS OU CONSÉCUTIFS RÉSULTANT DE L'UTILISATION DE TOUT PRODUIT DÉFECTUEUX COUVERT PAR CETTE GARANTIE.

## **COMMENT NOUS CONTACTER**

YSI Environmental, Inc. • 1725 Brannum Lane • Yellow Springs OH, 45387, États-Unis  
800-897-4151 • 937-767-7241 • Télécopie : 937-767-1058  
E-mail : [environmental@ysi.com](mailto:environmental@ysi.com) • Site Web : [www.ysi.com/environmental](http://www.ysi.com/environmental)

## TABLE DES MATIÈRES

INFORMATIONS GÉNÉRALES.....	2
INSPECTION INITIALE.....	2
PRÉCAUTIONS .....	2
Boîtier.....	2
Sonde.....	2
PRÉPARATION DE LA SONDÉ .....	3
INSTALLATION DE LA PILE .....	3
CLAVIER .....	3
ÉCRAN À CRISTAUX LIQUIDES .....	4
PROCÉDURES D'UTILISATION .....	4
MODES DE MESURE.....	4
CONFIGURATION DE L'ÉTALONNAGE.....	4
Exigences préalables.....	4
Procédure .....	5
ENTRETIEN DE LA SONDÉ.....	5
DÉPANNAGE.....	6
SPÉCIFICATIONS .....	6
CONVERSIONS.....	6
LISTE DES PIÈCES DÉTACHÉES RECOMMANDÉES .....	6

## **INFORMATIONS GÉNÉRALES**

L'YSI DO200 est un des trois instruments de la ligne de produits EcoSense® de YSI. L'YSI DO200 est un outil de précision mesurant l'oxygène dissous en pourcentage, ppm (mg/l) ainsi que sa température. Un microprocesseur incorporé stocke, calcule et compense tous les paramètres relatifs aux déterminations liées à l'oxygène dissous, y compris les caractéristiques de température des électrodes de détection de l'oxygène dissous.

L'appareil est doté d'un boîtier résistant aux éclaboussures, conforme à la norme IP65. Les touches mécaniques sont très fiables et fournissent une réaction tactile et sonore. Cet appareil utilise une pile de 9 V. Aucun réétalonnage n'est nécessaire lorsque l'alimentation électrique est rétablie.

L'avant de l'appareil dispose d'un écran à cristaux liquides affichant simultanément le pourcentage, les mg/l et la température de l'oxygène dissous, ainsi que les invites destinées à l'utilisateur et les indicateurs de mode. L'appareil émet des invites destinées à l'utilisateur lors des procédures d'étalonnage et de mesure.

Le modèle de sonde de terrain et de laboratoire DO200 utilise une électrode polarographique disposant de capuchons à membrane vissables. Les sondes de terrain 200-4 et 200-10 sont équipées d'une sonde de température incorporée permettant la compensation automatique de la température, ainsi que d'un corps en acier inoxydable qui en augmente la masse. La sonde de laboratoire 200-BOD est équipée d'un bloc d'alimentation électrique et comporte des électrodes remplaçables auto-agitées.

Parmi les autres caractéristiques, on notera la longue durée de vie des piles et une élimination du bruit élevée de 50/60 Hz c.a. Cet appareil est convivial et particulièrement souple dans les applications sur le terrain, industrielles et en laboratoire.

## **INSPECTION INITIALE**

Déballez soigneusement l'appareil et les accessoires et vérifiez qu'ils n'ont pas été endommagés lors de l'expédition. Comparez les pièces reçues aux matériaux répertoriés dans le bordereau d'emballage. Notifiez immédiatement YSI s'il s'avère que des pièces sont endommagées ou manquantes. Mettez de côté les matériaux d'emballage jusqu'à ce que le fonctionnement correct de l'appareil soit confirmé.

## **PRÉCAUTIONS**

### **Boîtier**

Bien que le modèle DO200 soit abrité dans un boîtier résistant aux éclaboussures conforme à la norme IP65, ne l'utilisez PAS sous l'eau, car son connecteur n'est pas étanche. Le boîtier résistant aux éclaboussures prévient les dommages permanents si l'appareil est accidentellement éclaboussé par des solutions non corrosives. En cas de submersion, prenez immédiatement les mesures suivantes :

1. Séchez le connecteur, le cas échéant, et remplacez la sonde d'oxygène dissous. Rincez soigneusement l'appareil avec de l'eau distillée. Après le rinçage et le séchage, inspectez et nettoyez les connecteurs en vue d'éliminer tout contaminant pouvant affecter les connexions de la sonde.
2. Attendez que l'appareil et la sonde soient parfaitement secs avant de reprendre les opérations.
3. Si l'appareil ne fonctionne pas correctement après les étapes 1 et 2, appelez YSI en vue d'une réparation ou d'un remplacement éventuels (voir la Garantie).

### **Les sondes (de terrain et de laboratoire)**

1. Les membranes durent plus longtemps si elles sont correctement installées et entretenues régulièrement. Des membranes endommagées ou sales et des grosses bulles dans le réservoir d'électrolyte peuvent entraîner des lectures incohérentes. Si les lectures sont instables ou la membrane endommagée, remplacez le capuchon à membrane et la solution de la sonde à oxygène (également appelée « Electrolyte de sondage d'oxygénométrie », chlorure de potassium ou solution KCl). Les intervalles de remplacement sont

habituellement de 4 à 8 semaines, bien qu'ils puissent se prolonger s'ils sont conservés en bon état de propreté. Les milieux particulièrement difficiles, tels que les eaux usées, peuvent exiger que la membrane soit remplacée toutes les 2 à 4 semaines. Des lectures instables peuvent avoir lieu si le capuchon à membrane est recouvert d'organismes consommant ou évoluant dans l'oxygène, tels que des bactéries ou des algues.

2. Le chlore, l'anhydride sulfureux, le monoxyde d'azote et l'oxyde nitreux peuvent affecter les lectures en se comportant comme de l'oxygène au niveau de la sonde.
3. Évitez les produits pouvant endommager les matériaux de la sonde, tels que l'acide concentré et les solvants puissants et caustiques. Les matériaux de la sonde comportent de l'acier inoxydable, de l'adhésif époxyde et du plastique ABS.
4. Gardez la cathode dorée de la sonde en bon état de propreté et texturée (lorsqu'elle est correctement entretenue, elle présente un fini mat). Si elle se ternit (après être entrée en contact avec certains gaz) ou présente un aspect argenté (en raison d'une utilisation prolongée avec une membrane lâche ou plissée), nettoyez-la en suivant les instructions de la section « Entretien de la sonde ».
5. Pour éviter que la membrane et l'électrode se dessèchent, stockez la sonde de terrain dans la bouteille d'étalonnage avec l'éponge humide et la sonde de laboratoire dans un flacon BOD avec 2,5 cm (1 po) d'eau pour les conserver dans un milieu saturé.

## **PRÉPARATION DE LA SONDE**

La sonde YSI DO200 est fournie avec une membrane protectrice sèche. Pour installer un nouveau capuchon à membrane sur la sonde :

1. Dévissez le capuchon à membrane de la sonde et jetez-le.
2. Remplissez un nouveau capuchon de solution de sondage d'oxygénométrie. Effectuez la préparation conformément aux instructions de la bouteille de solution.
3. Enfillez le capuchon à membrane rempli sur le capteur.
4. Laissez l'ensemble se réchauffer suffisamment longtemps lors de la première utilisation (10 à 15 minutes). Il se peut que le message « ovEr » s'affiche pendant ce temps sur l'écran. Cette condition est normale. Le message disparaîtra une fois le chauffage terminé.

## **INSTALLATION DE LA PILE**

Lorsque l'écran à cristaux liquides affiche pour la première fois « LOW BAT », il reste environ une heure de fonctionnement sur pile selon les spécifications. Remplacez la pile lorsque l'indication « LOW BAT » s'affiche sur l'écran.

Pour remplacer la pile, enlevez les deux vis du compartiment ainsi que le couvercle et le joint torique. Remplacez la pile de 9 V. Remplacez le couvercle et le joint torique (veillez à aligner le joint correctement afin d'assurer une bonne étanchéité) et revissez les deux vis du compartiment pour conserver une bonne résistance aux éclaboussures.

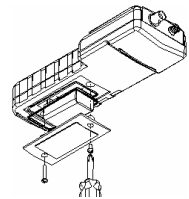




Figure 1.  
Installation de la pile

## **CLAVIER**

1.  : Met l'appareil hors ou sous tension.
2. **MODE** : En fonctionnement normal, bascule l'affichage entre la mesure de l'oxygène dissous exprimée en pourcentage de saturation de l'air ou exprimée en ppm (mg/l). En mode d'étalonnage, quitte l'étalonnage actuel et affiche le paramètre d'étalonnage suivant.
3. **CAL** : En fonctionnement normal, passe du mode Normal au mode Étalonnage (Calibration). Voir la section Configuration de l'étalonnage.
4.  : Lors de la configuration de l'étalonnage, appuyez sur cette touche pour enregistrer le paramètre actuel en mémoire.
5. **Touches Δ et ∇** : Augmentent ou diminuent la valeur affichée, comme voulu.

## ÉCRAN À CRISTAUX LIQUIDES

1. **BAT** : Indicateur de pile déchargée.
2. **CAL** : Indicateur de mode d'étalonnage (Calibration).
3. **SAL ppt** : S'affiche lors de l'étalonnage pour inviter l'utilisateur à indiquer la salinité approximative de l'échantillon, exprimée en parties par millier (ppt).
4. **mBar** : S'affiche lors de l'étalonnage pour inviter l'utilisateur à indiquer la pression barométrique.
5. Affichage principal des valeurs de l'oxygène dissous.
6. **%/ppm** : Indicateurs d'unité.
7. **°C** : Affichage de la température.

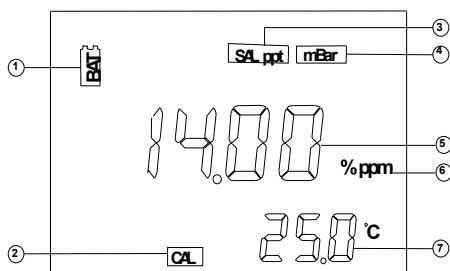



Figure 2. Écran à cristaux liquides

## PROCÉDURES D'UTILISATION

Appuyez sur  pour mettre l'appareil hors ou sous tension. L'appareil exécutera un test d'autodiagnostic pendant lequel le message « ovEr » peut s'afficher sur l'écran. Cette condition est normale. Le message disparaîtra une fois le chauffage terminé. Une fois que le test d'autodiagnostic est terminé, la température s'affiche dans la partie inférieure droite de l'écran et l'appareil est prêt à être utilisé. Plongez la sonde à mi-hauteur dans la solution de l'échantillon. Si possible, ne laissez pas la sonde toucher un objet quelconque dans la solution. Ne laissez aucune bulle se former autour de la sonde. Lorsque l'appareil n'est pas utilisé, mettez-le hors tension pour économiser la pile.

**REMARQUE** : Lors de la mesure de l'oxygène, la sonde doit être déplacée d'environ 15 cm (1/2 pied) par seconde pour compenser la consommation d'oxygène inhérente du capteur. Cependant, avec une sonde de laboratoire 200-BOD, utilisez simplement la fonction d'auto-agitation des sondes.

## MODES DE MESURE

Cet appareil permet trois mesures distinctes :

1. **Temperature (Température)** – La température actuelle de la solution s'affiche constamment.
2. **Dissolved Oxygen % (Pourcentage d'oxygène dissous)** – Mesure de l'oxygène en pourcentage de la saturation.
3. **Dissolved Oxygen ppm (Mg/l d'oxygène dissous)** – Mesure de l'oxygène en ppm (mg/l).





Observez soigneusement les unités affichées à l'extrémité de l'écran à cristaux liquides pour déterminer le mode voulu.

## CONFIGURATION DE L'ÉTALONNAGE

### **Exigences préalables**

1. La pression atmosphérique approximative (exprimée en millibars [mBar]) de la région où l'oxygène dissous doit être mesuré.
2. La salinité approximative de l'eau devant être analysée. L'eau douce a une salinité approximative de zéro. L'eau de mer a une salinité approximative de  $35 \times 10^3$ .
3. Pour une meilleure précision, réalisez l'étalonnage à une température aussi proche que possible de celle de l'échantillon.

## Procédure

1. Avec la sonde de terrain, déposez 5 ou 6 gouttes d'eau propre (courante, distillée ou désionisée) sur l'éponge, à l'intérieur de la bouteille d'étalonnage. Renversez la bouteille et laissez toute eau en excès s'écouler hors de la bouteille. L'éponge humide permet d'obtenir un milieu atmosphérique saturé à 100 % d'humidité pour la sonde, ce qui est optimal pour l'étalonnage et le stockage de la sonde du modèle DO200. Pour l'étalonnage, la sonde reste dans une atmosphère saturée d'humidité et n'est pas immergée.  
Avec la sonde de laboratoire, utilisez simplement la bouteille de stockage de la sonde avec environ 2,5 cm (1 po) d'eau au fond. Cela permet d'obtenir un milieu atmosphérique saturé à 100 % d'humidité pour la sonde, ce qui est optimal pour l'étalonnage et le stockage de la sonde du modèle 200-BOD. Pour l'étalonnage, la sonde reste dans une atmosphère saturée d'humidité et n'est pas immergée.
2. Avec la sonde de terrain, glissez-la dans la bouteille d'étalonnage. Veillez à ce que la membrane ne touche pas l'éponge.
3. Mettez le modèle DO200 sous tension en appuyant sur . Attendez 10 à 15 minutes que les lectures de l'oxygène dissous et de la température se stabilisent.
4. Appuyez sur **CAL**.
5. L'écran vous invite à indiquer la pression atmosphérique locale, exprimée en mBar. Utilisez les touches **Δ** et **∇**, respectivement, pour augmenter ou diminuer la valeur de la pression. Reportez-vous à la section intitulée « Conversions » pour convertir les unités de pression barométriques en mBar.
6. Lorsque la pression voulue est affichée, appuyez une fois sur  pour afficher la valeur d'étalonnage dans la partie inférieure droite de l'écran. Une fois que la valeur affichée dans l'écran principal se stabilise, appuyez à nouveau sur  pour passer à la procédure de compensation de la salinité.
7. L'écran vous invite à indiquer la salinité approximative de l'eau devant être analysée. Utilisez les touches **Δ** et **∇** pour augmenter ou diminuer la valeur de compensation de la salinité afin qu'elle corresponde à la valeur de l'échantillon (entre 0 et 40 parties par millier [ppt]). Une fois que la salinité correcte est affichée, appuyez sur .
8. L'appareil retient l'étalonnage même s'il est mis hors tension. Cependant, nous vous recommandons de vérifier l'étalonnage à chaque utilisation et de réaliser un nouvel étalonnage, le cas échéant, afin d'éviter toute déviation. La validité des lectures d'oxygène dissous dépend d'un bon étalonnage.

## **ENTRETIEN DE LA SONDE**

Pour nettoyer les sondes, utilisez le kit YSI de reconditionnement de sonde (YSI Probe Reconditioning kit) (numéro de référence 5238). Avec la sonde de laboratoire, utilisez le disque abrasif fourni dans le kit de membrane 5908 et suivez les consignes de nettoyage décrites dans le manuel de la sonde 200-BOD concernant le ponçage. En plus du kit de reconditionnement et du disque abrasif fourni dans le kit de membrane 5908, un nettoyage chimique peut s'avérer utile. Pour effectuer un nettoyage chimique de la sonde, trempez-la dans de l'ammoniaque.

1. Enlevez le capuchon à membrane et rincez la sonde avec de l'eau propre (courante, distillée ou désionisée).
2. Mettez l'appareil hors tension ou déconnectez la sonde.
3. Obtenez soit :
  - de l'ammoniaque de laboratoire à 14 % et laissez tremper la sonde 2 ou 3 minutes
  - de l'ammoniaque de nettoyage domestique à 3 % et laissez tremper la sonde de 8 à 12 heures.
4. Rincez la sonde de toute trace d'ammoniaque.
5. Utilisez le papier de verre (n° 400 sec/mouillé, fourni avec le kit 5238 et avec le kit de membrane 5908) pour poncer à l'eau la sonde et éliminer tout dépôt restant.
6. Installez un nouveau capuchon à membrane.

N'utilisez jamais de produits chimiques ou abrasifs non recommandés par YSI.

## DÉPANNAGE

L'écran principal affiche :	Solutions possibles :
« ovEr » ou « undr »	<ul style="list-style-type: none"> <li>• Vérifiez la membrane et la solution d'électrolyte.</li> <li>• Nettoyez l'anode et la cathode.</li> <li>• Retournez le produit au centre de service.</li> </ul>
L'écran secondaire affiche :	Solutions possibles :
« undr »	<ul style="list-style-type: none"> <li>• Réchauffez l'échantillon pour que sa température soit supérieure à -6,0 °C</li> <li>• Retournez le produit au centre de service.</li> </ul>
« ovEr »	<ul style="list-style-type: none"> <li>• Refroidissez l'échantillon pour que sa température soit inférieure à 46,0 °C</li> <li>• Retournez le produit au centre de service.</li> </ul>

## SPÉCIFICATIONS

Affichage	Fourchette	Précision	Résolution
Oxygène dissous (ppm ou mg/l)	0 à 20,00 ppm (mg/l)	Le plus grand de $\pm 2$ % de la lecture ou $\pm 2$ % de la saturation de l'air	0,01 mg/l
Oxygène dissous, pourcentage de la saturation de l'air	0 à 200,0 %	Le plus grand de $\pm 2$ % de la lecture ou $\pm 0,2$ ppm (mg/l)	0,1 %
Température °C (°F)	-6,0 à 46,0 °C (21 à 115 °F)	$\pm 0,3$ °C $\pm 1$ chiffre	0,1 °C

<b>Compensation de la pression</b>	600 à 1100 mBar (450 à 825 mmHg)
<b>Compensation de la salinité</b>	De 0,0 à 40,0 x 10 <sup>3</sup>
<b>Sonde CAT</b>	Thermistor, 10 K $\Omega$ , à 25 °C
<b>Sauvegarde de l'étalonnage</b>	Oui
<b>Touches sonores</b>	Oui, toutes les touches
<b>Source d'alimentation</b>	Une pile de 9 V
<b>Température de fonctionnement</b>	0 à 50 °C (32 à 122 °F)
<b>Boîtier de l'appareil</b>	Résistant aux éclaboussures, norme IP 65
<b>Poids (avec pile)</b>	350 g (0,75 de livre)
<b>Dimensions (L x P x H)</b>	186 mm x 70 mm x 37 mm (7,8 po x 2,8 po x 1,5 po)

## CONVERSIONS

Pour convertir :	Multiplier par :
Pouces de mercure en mBar	33,864
Pouces de mercure en mmHg	25,4
mmHg en mBar	1,333

## LISTE DES PIÈCES DÉTACHÉES RECOMMANDÉES

N° RÉF.	DESCRIPTION
200-4	Assemblage, câble de 4 mètres (environ 13 pieds) et sonde
200-10	Assemblage, câble de 10 mètres (environ 33 pieds) et sonde
200-BOD	Sonde BOD de laboratoire auto-agitante et câblage avec bloc d'alimentation
280	Sacoche de transport DO, flancs durs
5908	Kit de membrane, PE de 31,75 $\mu$ m (1,25 millième de pouce) d'épaisseur (605306), six capuchons à membrane et solution KCl
480	Sacoche de transport de l'appareil, souple

Article n° 605368 • Dessin n° A605368

Révision C • Septembre 2004

Pour la dernière version de ce manuel, visitez [www.ysi.com/environmental](http://www.ysi.com/environmental)

## **GARANTÍA**

El medidor YSI DO200 tiene un año de garantía contra defectos de materiales y fabricación, contado a partir de la fecha de compra por el usuario final. Las sondas y cables del medidor YSI DO200 tienen un año de garantía contra defectos de materiales y fabricación, contado a partir de la fecha de compra por el usuario final. Durante el período de garantía, YSI reparará o reemplazará, según su criterio, sin coste alguno, cualquier producto que YSI determine que está cubierto por esta garantía.

Para hacer valer esta garantía, escriba o llame al representante local de YSI, o comuníquese con el Servicio de atención al cliente de YSI en Yellow Springs, Ohio, EE.UU. Envíe el producto y la factura de compra, con el flete prepagado, al centro de servicio técnico autorizado seleccionado por YSI. Se realizará la reparación necesaria o el reemplazo y el producto será enviado de vuelta, con el flete prepagado. Los productos reparados o reemplazados se garantizan durante el resto del período de la garantía original, o al menos durante 90 días contados a partir de la fecha de reparación o reemplazo.

### **Limitación de la garantía**

Esta garantía no tendrá validez en caso de daños o fallos en el producto de YSI debido a lo siguiente: (i) la instalación, funcionamiento o utilización del producto de manera contraria a las instrucciones escritas suministradas por YSI; (ii) abuso o uso inadecuado del producto; (iii) falta de mantenimiento del producto de acuerdo con las instrucciones escritas suministradas por YSI o con los procedimientos estándar de la industria; (iv) cualquier reparación indebida realizada en el producto; (v) utilización por parte del usuario de componentes o repuestos defectuosos o inadecuados para el mantenimiento o reparación del producto; o (vi) cualquier modificación del producto no autorizada de manera expresa por YSI.

ESTA GARANTÍA SE OTORGA EN LUGAR DE CUALQUIER OTRA GARANTÍA, EXPLÍCITA O IMPLÍCITA, LO QUE INCLUYE TODA GARANTÍA DE COMERCIALIZACIÓN O IDONEIDAD PARA UN PROPÓSITO ESPECÍFICO. DE CONFORMIDAD CON ESTA GARANTÍA, LA RESPONSABILIDAD DE YSI SE LIMITA A LA REPARACIÓN O REEMPLAZO DEL PRODUCTO, LO CUAL SERÁ LA SOLUCIÓN ÚNICA Y EXCLUSIVA QUE TENDRÁ EL COMPRADOR POR CUALQUIER PRODUCTO DEFECTUOSO CUBIERTO POR ESTA GARANTÍA. EN NINGÚN CASO, YSI SERÁ RESPONSABLE POR NINGÚN DAÑO CUANTIFICABLE, INDIRECTO, INCIDENTAL O CONSIGUIENTE QUE RESULTARA DE ALGÚN PRODUCTO DEFECTUOSO CUBIERTO POR ESTA GARANTÍA.

## **INFORMACIÓN DE CONTACTO**

YSI Environmental, Inc. • 1725 Brannum Lane • Yellow Springs OH, 45387, EE.UU.  
800-897-4151 • 937-767-7241 • Fax: 937-767-1058  
Correo electrónico: [environmental@ysi.com](mailto:environmental@ysi.com) • Página en Internet: [www.ysi.com/environmental](http://www.ysi.com/environmental)



## CONTENIDO

PRESENTACIÓN GENERAL.....	2
INSPECCIÓN INICIAL .....	2
PRECAUCIONES.....	2
Estuche .....	2
Sonda.....	2
PREPARACIÓN DE LA SONDA.....	3
INSTALACIÓN DE LA PILA .....	3
TECLAS.....	3
PANTALLA DE CRISTAL LÍQUIDO.....	4
INSTRUCCIONES DE FUNCIONAMIENTO.....	4
MODOS DE MEDICIÓN.....	4
AJUSTE DE LA CALIBRACIÓN.....	4
Requisitos .....	4
Procedimiento .....	5
MANTENIMIENTO DE LA SONDA.....	5
LOCALIZACIÓN DE FALLOS .....	6
ESPECIFICACIONES .....	6
CONVERSIONES .....	6
LISTA DE REPUESTOS RECOMENDADOS.....	7

## **PRESENTACIÓN GENERAL**

El medidor YSI DO200 es uno de los tres medidores de la línea de productos EcoSense® de YSI. El medidor YSI DO200 es un instrumento de precisión que mide el oxígeno disuelto mostrándolo en porcentajes y en ppm (mg/L), y también mide la temperatura. Tiene un microprocesador integrado que almacena, calcula y realiza la compensación de todos los parámetros relacionados con la determinación del oxígeno disuelto, incluso, las características de temperatura del electrodo de oxígeno disuelto.

Esta unidad cuenta con un estuche IP65 resistente a salpicaduras. Las teclas de contacto mecánico son muy confiables y al pulsarlas proporcionan una respuesta táctil y audible. Este instrumento utiliza una pila de 9 voltios. No requiere nueva calibración cuando se restablece la corriente.

La parte delantera del instrumento tiene una pantalla grande de cristal líquido que muestra simultáneamente el oxígeno disuelto en valor porcentual, en partes por millón (ppm) y la temperatura, junto con las indicaciones para el usuario y los indicadores del modo de funcionamiento. La unidad orienta al usuario durante los procedimientos de calibración y medición.

Las sondas de campo y de laboratorio modelo DO200 utilizan un electrodo polarográfico con cápsulas prácticas de membrana enrosables. Las sondas de campo 200-4 y 200-10 cuentan con una sonda integrada para temperatura que realiza la compensación automática de la temperatura, así como una estructura de acero inoxidable que proporciona más peso. La sonda de laboratorio 200-BOD cuenta con alimentación de corriente e incluye autoagitación y electrodos reemplazables.

Otras características incluyen una pila de larga duración y un mecanismo de eliminación de ruido de 50/60 Hz CA. Este medidor es universal y fácil de usar en aplicaciones *in situ*, industriales y de laboratorio.

## **INSPECCIÓN INICIAL**

Saque la unidad de su embalaje con cuidado y verifique que no haya sufrido daños durante el envío. Compare las piezas recibidas con los materiales enumerados en la lista de embalaje. Notifique inmediatamente a YSI en caso de que haya piezas faltantes o dañadas. Guarde todos los materiales de embalaje hasta que confirme que la unidad funciona satisfactoriamente.

## **PRECAUCIONES**

### **Estuche**

Aunque el medidor DO200 está alojado en un estuche IP65 resistente a las salpicaduras, NO debe usarse bajo el agua, ya que el conector no es hermético. Este tipo de estuche evita los daños permanentes en la unidad en caso de que sea accidentalmente salpicada con soluciones no corrosivas. En caso de inmersión, siga estos pasos de inmediato:

1. Seque el conector, si es necesario, y cambie la sonda de oxígeno disuelto. Enjuague la unidad cuidadosamente con agua destilada. Después del enjuague y secado, revise y limpie los conectores para eliminar cualquier contaminante que pueda afectar las conexiones de la sonda.
2. Espere hasta que la unidad y la sonda se sequen por completo antes de reanudar el funcionamiento.
3. Si la unidad no funciona correctamente después de realizar los pasos 1 y 2, comuníquese con YSI para su posible reparación o reemplazo (consulte la garantía).

### **Sondas (Campo y laboratorio)**

1. Las membranas durarán más tiempo si se instalan correctamente y se les hace mantenimiento con frecuencia. Pueden producirse lecturas erráticas si las membranas están dañadas o sucias o si hay burbujas grandes en el depósito del electrólito. Si se producen lecturas inestables o daños en la membrana, cambie tanto la cápsula de la

membrana como la solución de la sonda de oxígeno (también llamada “electrólito de la sonda de O<sub>2</sub>”, cloruro potásico o solución KCl). En promedio, estos cambios deben hacerse cada 4 a 8 semanas, aunque la cápsula y la solución pueden durar más tiempo si se mantienen limpias. En ambientes arduos, por ejemplo, en aguas residuales, puede ser necesario cambiar la membrana cada 2 a 4 semanas. Pueden producirse lecturas inestables si la cápsula de la membrana está recubierta de microorganismos que consuman o transformen oxígeno, como las bacterias y las algas.

2. El cloro, el dióxido de azufre, el óxido nítrico y el óxido nitroso pueden afectar las lecturas, ya que se comportan de manera similar al oxígeno en la sonda.
3. Evite las sustancias que puedan dañar los materiales de la sonda, tales como ácidos concentrados, cáusticos y solventes fuertes. Los materiales de la sonda incluyen acero inoxidable, epoxia y copolímeros acrilonitrilo, butadieno y estireno (ABS).
4. Mantenga el cátodo de oro de la sonda limpio y con la misma textura (cuando el mantenimiento es adecuado, el acabado es mate). Si está manchado (por el contacto con ciertos gases) o recubierto de plata (debido al uso prolongado con la membrana floja o arrugada), deberá limpiarlo según las instrucciones de la sección “Mantenimiento de la sonda”.
5. Para evitar que la membrana y el electrólito se sequen, almacene la sonda de campo en la botella de calibración con la esponja húmeda y la sonda de laboratorio en una botella BOD con 2,5 cm (1 pulgada) de agua para mantenerlas en un ambiente saturado de aire.

## **PREPARACIÓN DE LA SONDA**

La sonda del YSI DO200 viene con una membrana protectora seca. Instrucciones para instalar una cápsula nueva en la membrana de la sonda:

1. Desenrosque la cápsula de la membrana de la sonda y deséchela.
2. Llene una nueva cápsula con solución para sondas de oxígeno. Prepare la solución de acuerdo con las instrucciones de la botella.
3. Enrosque la cápsula llena en el sensor.
4. Deje que la solución se caliente antes de utilizarla por primera vez (de 10 a 15 minutos). Durante este tiempo puede aparecer un mensaje “ovEr” en la pantalla. Esto es normal. El mensaje desaparecerá cuando se haya completado el calentamiento.

## **INSTALACIÓN DE LA PILA**

En la pantalla de cristal líquido aparecerá el mensaje de “LOW BAT” (pila descargada) para indicar que queda aproximadamente una hora de carga de la pila para el funcionamiento de la unidad según las especificaciones. Cambie la pila cuando aparezca el mensaje “LOW BAT” en la pantalla de cristal líquido.

Para cambiar la pila, saque los dos tornillos de la tapa y luego retire la tapa y el aro tórico. Coloque una nueva pila de 9 voltios. Vuelva a colocar la tapa y el aro tórico (asegúrese de alinear este aro correctamente para garantizar un buen sellado) y ajuste los dos tornillos de la tapa para que funcione la protección contra salpicaduras.

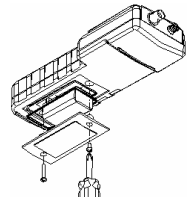



Figura 1.  
Instalación de la batería

## **TECLAS**

1. **⏻**: Para encender y apagar la unidad.
2. **MODE (MODO)**: Durante el funcionamiento normal, hace que la pantalla muestre alternadamente el oxígeno disuelto en un porcentaje de aire saturado y en ppm (mg/L). En el modo Calibración (Calibración), sale de la calibración actual y muestra el siguiente parámetro de calibración.
3. **CAL**: Durante el funcionamiento normal, cambia el modo de Normal a Calibration (Calibración). Consulte la sección “Ajuste de la calibración”.

4. : En el ajuste de la calibración, pulse esta tecla para guardar en la memoria el parámetro actual.
5. **Teclas Δ y ∇**: Para aumentar o disminuir el valor que aparece en la pantalla como sea conveniente.

## **PANTALLA DE CRISTAL LÍQUIDO**

1. **BAT**: Indicador de pila descargada.
2. **CAL**: Indicador del modo de calibración.
3. **SAL ppt**: Aparece durante la calibración cuando se pide al usuario la salinidad aproximada de la muestra en partes por millar (ppt).
4. **mBar**: Aparece durante la calibración para pedir al usuario la presión barométrica.
5. Pantalla principal que muestra los valores del oxígeno disuelto.
6. **%/ppm**: Indicadores de la unidad.
7. **°C**: Indicador de la temperatura.

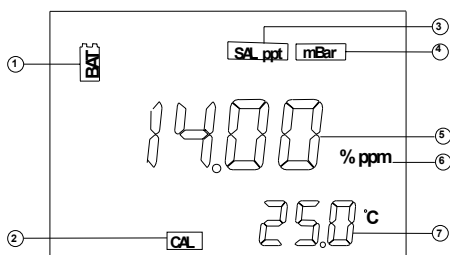



Figura 2. Pantalla de cristal líquido

## **INSTRUCCIONES DE FUNCIONAMIENTO**

Pulse la tecla  para encender y apagar la unidad. El instrumento llevará a cabo una prueba de autodiagnóstico, durante la cual puede aparecer un mensaje "ovEr" en la pantalla. Esto es normal. El mensaje desaparecerá cuando se haya completado el calentamiento. Después de completar la prueba de autodiagnóstico, aparecerá la temperatura en la parte inferior derecha de la pantalla y la unidad estará lista para funcionar. Sumerja la sonda hasta la mitad en la solución de muestra. A ser posible, no permita que la sonda haga contacto con ningún objeto sólido en la solución. No permita que haya burbujas alrededor de la sonda. Cuando la unidad no esté en uso, apáguela para ahorrar carga de la pila.

**NOTA:** Durante la medición de oxígeno, se debe mover la sonda unos 15 cm (1/2 pie) por segundo para contrarrestar el consumo de oxígeno que hace el sensor. Sin embargo, cuando se usa la sonda de laboratorio 200-BOD, utilice simplemente la característica de autoagitación.

## **MODOS DE MEDICIÓN**

Esta unidad realiza tres mediciones distintas:

1. **Temperatura:** la pantalla muestra constantemente la temperatura actual de la solución.
2. **% de oxígeno disuelto:** medición del oxígeno en porcentaje de saturación.
3. **Oxígeno disuelto en ppm:** medición del oxígeno en ppm (mg/L).

Observe detenidamente las unidades mostradas en el extremo de la pantalla de cristal líquido para determinar el modo deseado.

## **AJUSTE DE LA CALIBRACIÓN**

### **Requisitos**





1. La presión aproximada (en milibares [mBar]) de la región en la que se mide el oxígeno disuelto.
2. La salinidad aproximada del agua que se analizará. El agua dulce tiene aproximadamente cero de salinidad. El agua de mar tiene una salinidad aproximada de 35 partes por millar (ppt).

3. Para lograr mayor precisión, haga todas las calibraciones con una temperatura que sea lo más similar posible a la temperatura de la muestra.

## Procedimiento

1. Para la sonda de campo, ponga 5 ó 6 gotas de agua limpia (de grifo, destilada o desionizada) en la esponja que se encuentra dentro de la botella de calibración. Dé vuelta a la botella y permita que se vacíe todo el exceso de agua que tenga dentro. La esponja humedecida crea para la sonda un ambiente de aire con 100 % de saturación de agua, el cual es ideal para la calibración, transporte y almacenamiento de la sonda modelo DO200. Para la calibración, la sonda permanece en una atmósfera de aire saturada de agua y no sumergida.

Para la sonda de laboratorio, utilice simplemente la misma botella en que se almacena la sonda con aproximadamente 2,5 cm (1 pulgada) de agua en el fondo. Esto crea para la sonda un ambiente de aire con 100 % de saturación de agua, el cual es ideal para la calibración y el almacenamiento de la sonda modelo 200-BOD. Para la calibración, la sonda permanece en una atmósfera de aire saturada de agua y no sumergida.

2. Deslice la sonda de campo hacia el interior de la botella de calibración. Asegúrese de que la membrana no haga contacto con la esponja.
3. Pulse la tecla  para encender la unidad DO200. Espere entre 10 y 15 minutos para que se establezcan las lecturas del oxígeno disuelto y de la temperatura.
4. Pulse la tecla **CAL**.
5. La pantalla de cristal líquido le pedirá la presión local expresada en mBar. Con las teclas  $\Delta$  y  $\nabla$  aumente o disminuya, respectivamente, el valor de la presión. Vea la sección titulada "Conversiones" para convertir las unidades de presión barométrica a milibares.
6. Cuando aparezca en pantalla la presión correcta, pulse la tecla  una vez para ver el valor de calibración en la parte inferior derecha de la pantalla. Una vez que el valor en la pantalla se estabilice, pulse la tecla  nuevamente para pasar al procedimiento de compensación de salinidad.
7. La pantalla le pedirá la salinidad aproximada del agua que se analizará. Con las teclas  $\Delta$  y  $\nabla$  aumente o disminuya el valor de compensación de la salinidad de la muestra (entre 0 y 40 partes por millar [ppt]). Cuando aparezca la salinidad correcta, pulse la tecla .
8. La calibración queda registrada aun cuando la unidad se apague. No obstante, se recomienda verificar la calibración en cada uso y recalibrar si es necesario para evitar el desplazamiento. La lectura del oxígeno disuelto sólo es precisa cuando la calibración también lo es.

## MANTENIMIENTO DE LA SONDA

Para limpiar las sondas, utilice el juego de reacondicionamiento de sonda de YSI (número de componente 5238), para la sonda de campo. Para la sonda de laboratorio, utilice el disco de lijado incluido en el juego de membranas 5908 y siga las instrucciones de limpieza descritas en el manual de la sonda 200-BOD con respecto al lijado. Además de utilizar este juego y el disco de lijado con su juego de membranas 5908, se le puede hacer una limpieza química. Para limpiar los electrodos químicamente, prepare una solución de remojo con hidróxido de amonio.

1. Quite la cápsula de la membrana y enjuague la sonda con agua limpia (de grifo, destilada o desmineralizada).
2. Apague la unidad y desconecte la sonda.
3. Utilice uno de los siguientes métodos:
  - Hidróxido de amonio al 14 % de concentración para uso en laboratorios y remoje la sonda durante 2 ó 3 minutos.
  - Amoniaco al 3 % de concentración para uso doméstico y ponga la sonda en remojo de un día para otro (de 8 a 12 horas).
4. Enjuague el hidróxido de amonio o el amoniaco de la sonda.
5. Con papel de lija (de grano 400 para superficies húmedas y secas, incluido con el juego 5238 y con el juego de membranas 5908) elimine (lijado en húmedo) cualquier exceso depositado en la sonda.

6. Instale una nueva cápsula en la membrana.

Nunca utilice productos químicos ni abrasivos que no estén recomendados por YSI.

## LOCALIZACIÓN DE FALLOS

<b>La pantalla principal muestra:</b>	<b>Posibles soluciones:</b>
“ovEr” o “undr”	<ul style="list-style-type: none"> <li>• Revise la membrana y la solución de electrolitos.</li> <li>• Limpie el ánodo y el cátodo.</li> <li>• Envíe el producto al servicio técnico.</li> </ul>
<b>La pantalla secundaria muestra:</b>	<b>Posibles soluciones:</b>
“undr”	<ul style="list-style-type: none"> <li>• Caliente la muestra hasta una temperatura mayor a -6,0 °C.</li> <li>• Envíe el producto al servicio técnico.</li> </ul>
“ovEr”	<ul style="list-style-type: none"> <li>• Enfríe la muestra hasta una temperatura menor a 46,0° C.</li> <li>• Envíe el producto al servicio técnico.</li> </ul>

## ESPECIFICACIONES

Pantalla	Escala	Precisión	Resolución
O <sub>2</sub> disuelto (ppm o mg/L)	0 a 20,00 ppm (mg/L)	±2 % de la lectura o ±2 % de saturación del aire, lo que sea mayor	0,01 mg/L
O <sub>2</sub> disuelto % de sat de aire	0 a 200,0 %	±2 % de la lectura o ±0,2 ppm, lo que sea mayor	0,1 %
Temperatura en °C (°F)	-6,0 a 46,0° C (21 a 115° F)	±0,3° C ±1 cifra	0,1° C

<b>Compensación de la presión</b>	600 a 1100 mBar (450 a 825 mmHg)
<b>Compensación de la salinidad</b>	De 0,0 a 40,0 ppt
<b>Sonda ATC</b>	Termistor, 10KΩ, a 25° C
<b>Respaldo de la calibración</b>	Sí
<b>Respuesta audible</b>	Sí, en todas las teclas
<b>Fuente de corriente</b>	Una pila de 9 voltios
<b>Temperatura de funcionamiento</b>	0 a 50° C (32 a 122° F)
<b>Estuche del medidor</b>	IP 65, resistente a salpicaduras
<b>Peso (con la pila)</b>	350 gramos (0,75 libras)
<b>Dimensiones (anc x prof x alt)</b>	186 mm x 70 mm x 37 mm (7,3 pulg. x 2,8 pulg. x 1,5 pulg.)

## CONVERSIONES

<b>Para convertir:</b>	<b>Multiplique por:</b>
Pulgadas de Hg a mBar	33,864
Pulgadas de Hg a mmHg	25,4
mmHg a mBar	1,333

## **LISTA DE REPUESTOS RECOMENDADOS**

<b>PIEZA N°</b>	<b>DESCRIPCIÓN</b>
200-4	Conjunto de sonda de 4 metros (aproximadamente 13 pies) y cables
200-10	Conjunto de sonda de 10 metros (aproximadamente 33 pies) y cables
200-BOD	Conjunto de sonda de laboratorio BOD con autoagitación y cables con alimentación de corriente
280	Estuche portátil para oxígeno disuelto, de lados rígidos
5908	Conjunto de membranas, 31,75 µm (1,25 mil) PE (605306), seis membranas con cápsula y solución KCl
480	Estuche portátil para medidor, no rígido

## **GARANTIE**

Für das Instrument YSI DO200 wird für den Zeitraum von einem (1) Jahr ab dem Datum des Kaufs durch den Endbenutzer eine Garantie bezüglich Material- und Fabrikationsfehlern gewährt. Für YSI DO200-Sonden und -Kabel wird für den Zeitraum von einem (1) Jahr ab dem Datum des Kaufs durch den Endbenutzer eine Garantie bezüglich Material- und Fabrikationsfehlern gewährt. Innerhalb der Garantiefrist wird YSI jedes Produkt, auf das diese Garantie anwendbar ist, nach eigenem Ermessen entweder kostenlos reparieren oder ersetzen.

Setzen Sie sich schriftlich oder telefonisch mit Ihrem örtlichen YSI-Vertreter in Verbindung oder kontaktieren Sie den YSI-Kundendienst in Yellow Springs, Ohio (USA), um diese Garantie in Anspruch zu nehmen. Schicken Sie das Produkt mit dem Kaufnachweis unter Vorauszahlung der Frachtkosten an das von YSI ausgewählte Vertragskundendienstzentrum. Dort wird die Reparatur oder der Ersatz vorgenommen und das Produkt anschließend frachtfrei an Sie zurückgesandt. Für reparierte oder ersetzte Produkte erstreckt sich die Garantie über die Restlaufzeit des ursprünglichen Garantiezeitraums, mindestens jedoch über 90 Tage ab dem Datum der Reparatur oder des Ersatzes.

### **Garantiebegrenzung**

Diese Garantie gilt nicht für irgendwelche Beschädigungen oder Ausfälle eines YSI-Produkts, die durch Folgendes verursacht werden: (i) Versäumnis, das Produkt in Übereinstimmung mit den schriftlichen Instruktionen von YSI zu installieren, in Betrieb zu nehmen oder zu benutzen; (ii) Missbrauch oder Zweckentfremdung des Produkts; (iii) Versäumnis, das Produkt in Übereinstimmung mit den schriftlichen Instruktionen von YSI oder einem branchenüblichen Verfahren in Stand zu halten; (iv) unsachgemäße Reparaturen am Produkt; (v) eine von Ihnen vorgenommene Verwendung defekter oder ungeeigneter Komponenten oder Teile bei der Wartung oder Reparatur des Produkts; oder (vi) die Abänderung des Produkts in irgendeiner Weise, die nicht ausdrücklich von YSI genehmigt ist.

DIESE GARANTIE TRITT AN DIE STELLE ALLER ANDEREN GEWÄHRLEISTUNGEN, GLEICHGÜLTIG, OB VERTRAGLICH ODER GESETZLICH ZUGESICHERT, EINSCHLIESSLICH JEGLICHER ZUSICHERUNG ALLGEMEINER GEBRAUCHSTAUGLICHKEIT ODER EIGNUNG FÜR EINEN BESTIMMTEN ZWECK. DIE HAFTUNG VON YSI GEMÄSS DIESER GARANTIE BESCHRÄNKT SICH AUF DIE REPARATUR ODER DEN ERSATZ DES PRODUKTS, UND DIES STELLT IHREN EINZIGEN UND AUSSCHLIESSLICHEN RECHTSBEHELF FÜR JEDES DEFEKTE PRODUKT DAR, DAS UNTER DIESE GARANTIE FÄLLT. YSI HAFTET AUF KEINEN FALL FÜR IRGENDWELCHE BESONDEREN, MITTELBAREN, BEILÄUFIG ENTSTANDENEN ODER FOLGESCHÄDEN, DIE AUS IRGEND EINEM DEFEKTEN PRODUKT RESULTIEREN, DAS UNTER DIESE GARANTIE FÄLLT.

## **KONTAKTINFORMATION**

YSI Environmental, Inc. • 1725 Brannum Lane • Yellow Springs, OH 45387, USA  
800-897-4151 • 937-767-7241 • Fax: 937-767-1058  
Email: [environmental@ysi.com](mailto:environmental@ysi.com) • Website: [www.ysi.com/environmental](http://www.ysi.com/environmental)



## INHALTSVERZEICHNIS

ALLGEMEINE EINLEITUNG.....	2
INSPEKTION VOR DEM EINSATZ .....	2
VORSICHTSMASSNAHMEN.....	2
Das Gehäuse .....	2
Die Sonde .....	2
VORBEREITUNG DER SONDE .....	3
EINSETZEN DER BATTERIE .....	3
DAS TASTENFELD.....	3
DAS LCD-ANZEIGEFELD.....	4
BEDIENUNGSVERFAHREN .....	4
MESSUNGS-BETRIEBSARTEN .....	4
KALIBRIERUNGSEINSTELLUNG .....	5
Voraussetzungen.....	5
Verfahren .....	5
WARTUNG UND PFLEGE DER SONDE .....	6
AUFFINDEN UND BESEITIGEN VON STÖRUNGEN .....	6
TECHNISCHE DATEN.....	7
UMRECHNUNGEN .....	7
LISTE EMPFOHLENER ERSATZTEILE.....	7

## **ALLGEMEINE EINLEITUNG**

Das YSI DO200 ist eines von drei Instrumenten aus der EcoSense®-Produktgruppe von YSI. Das DO200 ist ein Präzisionsinstrument, das gelösten Sauerstoff in Prozent bzw. Teilen pro Million (mg/L) und die Temperatur misst. Ein eingebauter Mikroprozessor speichert, berechnet und kompensiert alle Parameter, die mit der Bestimmung des gelösten Sauerstoffs in Zusammenhang stehen, einschließlich der Temperatur-Charakteristika der Elektrode für gelösten Sauerstoff.

Dieses Gerät besitzt ein spritzwasseres Gehäuse gemäß der Schutzklasse IP65. Die mechanischen Berührungstasten mit fühlbarem und hörbarem Feedback sind äußerst zuverlässig. Das Instrument wird von einer 9 Volt-Batterie gespeist. Es ist keine erneute Kalibrierung notwendig, wenn die Stromversorgung wiederhergestellt wird.

Auf der Vorderseite des Instruments befindet sich ein großes LCD-Anzeigefeld, das gleichzeitig die Werte für den gelösten Sauerstoff in Prozent, Teile pro Million (ppm) sowie die Temperatur mit Bedienerhinweisen/Eingabeaufforderungen und die Betriebsart anzeigt. Das Gerät führt den Benutzer durch die Kalibrierungs- und Messverfahren.

Die für den Außenbereich und das Labor vorgesehenen Sonden des Modells DO200 verwenden eine polarografische Elektrode mit praktischen Schraubkappenmembranen. Die Sonden 200-4 und 200-10 für den Außenbereich sind mit einem eingebauten Temperaturfühler zur automatischen Temperaturkompensation ausgestattet und haben einen Edelstahlkörper für zusätzliches Sinkgewicht. Die Sonde 200-BOD für die Arbeit im Labor ist mit einem Stromversorgungsgerät versehen und enthält selbstbrühende und ersetzbare Elektroden.

Zu den weiteren Merkmalen gehören eine lange Batterielebensdauer und eine hohe 50/60 Hz WS-Störgeräuschunterdrückung. Das Instrument ist universell einsetzbar und in benutzerfreundlicher Weise für Anwendungen in der Feldforschung, in der Industrie und im Labor geeignet.

## **INSPEKTION VOR DEM EINSATZ**

Packen Sie das Gerät und sein Zubehör sorgfältig aus und untersuchen Sie alle Teile auf eventuelle Transportschäden. Vergleichen Sie die erhaltenen Teile mit den Gegenständen, die auf dem Packzettel aufgeführt sind. Benachrichtigen Sie YSI unverzüglich über irgendwelche Schäden oder fehlende Teile. Bewahren Sie das Verpackungsmaterial auf, bis der einwandfreie Betrieb des Geräts bestätigt ist.

## **VORSICHTSMASSNAHMEN**

### **Das Gehäuse**

Obwohl das DO200-Instrument in einem spritzwassergeschützten IP65-Gehäuse untergebracht ist, DARF ES NICHT unter Wasser eingesetzt werden; das Anschlussstück ist nicht wasserfest. Das spritzwassergeschützte Gehäuse verhindert permanente Schäden am Gerät, falls es versehentlich mit nichtätzenden Lösungen besprüht wird. Im Falle eines Eintauchens in eine Flüssigkeit müssen sofort die folgenden Schritte ausgeführt werden:

1. Trocknen Sie das Anschlussstück, falls notwendig, und ersetzen Sie die Sonde für gelösten Sauerstoff. Spülen Sie das Gerät sorgfältig mit destilliertem Wasser ab. Nach dem Abspülen und Trocknen sollten Sie die Anschlussstücke inspizieren und säubern, um alle verunreinigenden Substanzen zu entfernen, die die Sondenanschlüsse beeinträchtigen könnten.
2. Warten Sie, bis das Gerät und die Sonde völlig trocken sind, bevor Sie das Gerät wieder in Betrieb nehmen.
3. Falls das Gerät nach den Schritten 1 und 2 nicht korrekt funktionieren sollte, rufen Sie YSI wegen einer möglichen Reparatur oder eines Ersatzes an (siehe Garantie).

### **Die Sonden (Außenbereich und Labor)**

1. Die Membranen halten länger, wenn sie richtig installiert und regelmäßig gewartet werden. Stark schwankende Messwerte können die Folge beschädigter oder verschmutzter

Membranen sein oder von großen Blasen im Elektrolytbehälter herrühren. Falls instabile Ablesungen oder Membranschäden auftreten, sollten Sie sowohl die Membrankappe als auch die Sauerstoff-Sondenlösung (auch als „O<sub>2</sub> Sonden-Elektrolyt“, Kaliumchlorid- oder KCl-Lösung bezeichnet) auswechseln. Das durchschnittliche Auswechslungsintervall beträgt 4 bis 8 Wochen. Die Membranen können länger halten, wenn sie sauber gehalten werden. Unter harten Umgebungsbedingungen, wie beispielsweise Abwasser, müssen die Membranen unter Umständen alle 2 bis 4 Wochen ausgewechselt werden. Instabile Ablesungen können vorkommen, falls die Membrankappe mit Sauerstoff verbrauchenden oder entwickelnden Organismen, wie beispielsweise Bakterien oder Algen, überzogen ist.

2. Chlor, Schwefeldioxid, Stickoxid und Distickstoffoxid können die Messwertablesungen beeinträchtigen, indem sie sich an der Sonde wie Sauerstoff verhalten.
3. Vermeiden Sie Substanzen, die das Sondenmaterial beschädigen könnten, wie zum Beispiel konzentrierte Säure, Ätzmittel (Kautika) und starke Lösungsmittel. Zum Sondenmaterial gehören Edelstahl, Epoxidharz und ABS-Kunststoff.
4. Halten Sie die Goldkathode der Sonde sauber und strukturiert (sie besitzt eine mattierte Oberfläche, wenn sie richtig in Stand gehalten wird). Falls sie (durch Kontakt mit bestimmten Gasen) anläuft oder (durch längere Benutzung mit einer lockeren oder runzligen Membrane) mit Silber plattiert wird, muss sie entsprechend den Anweisungen im Abschnitt „Wartung und Pflege der Sonde“ gereinigt werden. xxx
5. Um ein Austrocknen der Membrane und der Elektrolytlösung zu verhindern und die Sonden in feuchter Umgebungsluft aufzubewahren, sollte die Außenbereichssonde in der Kalibrierungsflasche mit dem befeuchteten Schwamm und die Laborsonde in einer BOD-Flasche mit etwa 2,5 cm (1 Zoll) Wasser aufbewahrt werden.

## **VORBEREITUNG DER SONDE**

Die YSI DO200-Sonde wird mit einer trockenen Schutzmembrane ausgeliefert. Installieren Sie eine neue Membrankappe folgendermaßen auf der Sonde:

1. Schrauben Sie die Membrankappe der Sonde ab und entsorgen Sie sie.
2. Füllen Sie eine neue Kappe mit Sauerstoff-Sondenlösung. Bereiten Sie die Lösung anhand der Hinweise auf der Lösungsflasche zu.
3. Schrauben Sie die gefüllte Membrankappe auf den Sensor.
4. Erlauben Sie genügend Aufwärmzeit vor dem ersten Einsatz (10 bis 15 Minuten). Während dieser Zeit erscheint möglicherweise die Mitteilung „ovEr“ auf dem Anzeigefeld. Dies ist normal. Nach dem Ende des Aufwärmens verschwindet die Mitteilung wieder.

## **EINSETZEN DER BATTERIE**

Eine anfängliche Anzeige von „LOW BAT“ auf dem LCD bedeutet, dass das Gerät noch ca. 1 Stunde innerhalb der Spezifizierungen mit der Batterie betrieben werden kann. Wechseln Sie die Batterie aus, wenn „LOW BAT“ auf dem LCD-Anzeigefeld erscheint.

Zum Austausch der Batterie entfernen Sie die beiden Schrauben der Batterieabdeckung, die Batterieabdeckung und den O-Ring. Wechseln Sie die 9 Volt-Batterie aus. Setzen Sie die Batterieabdeckung und den O-Ring wieder ein (achten Sie auf die korrekte Ausrichtung des O-Rings, um eine schlechte Abdichtung zu vermeiden) und ziehen Sie die beiden Schrauben der Batterieabdeckung fest, damit das Gerät spritzwassergeschützt bleibt.

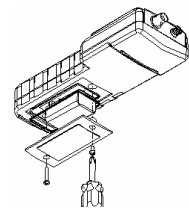



Abbildung 1.  
Einsetzen der Batterie

## **DAS TASTENFELD**

1. : Schaltet das Gerät ein oder aus.
2. **MODE**: Schaltet im Normalbetrieb die Anzeige zwischen gelöstem Sauerstoff in Prozent Luftsättigung und gelöstem Sauerstoff in Teilen pro Million (ppm [mg/L]) hin und her. Im Kalibrierungsmodus wird damit die aktuelle Kalibrierung verlassen und der nächste Kalibrierungsparameter angezeigt.

- CAL:** Ändert im Normalbetrieb die Betriebsart von Normal auf Kalibrierung. Siehe Kalibrierungseinstellung.
- : Drücken Sie in der Kalibrierungseinstellung auf diese Taste, um den aktuellen Parameter zu speichern.
- Δ und ▽ Tasten:** Damit wird der Anzeigewert nach Wunsch erhöht oder verringert.

## DAS LCD-ANZEIGEFELD

- BAT:** Anzeige für niedrigen Batteriestand.
- CAL:** Anzeige für den Kalibrierungsmodus.
- SAL ppt:** Wird während der Kalibrierung angezeigt, wenn der Benutzer aufgefordert wird, den ungefähren Salzgehalt der Probe in Teilen pro Tausend einzugeben (ppt).
- mBar:** Wird während der Kalibrierung angezeigt, aufzufordern, den Luftdruck einzugeben.
- Hauptanzeige für Werte des gelösten Sauerstoffs.
- % / ppm:** Anzeigen für die Maßeinheit.
- °C:** Temperaturanzeige.

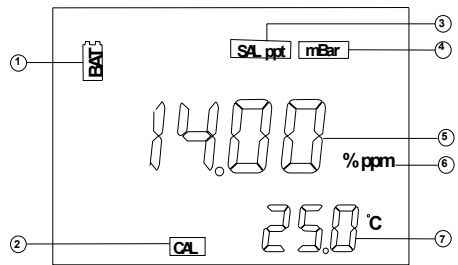



Abbildung 2. LCD-Anzeigefeld

## BEDIENUNGSVERFAHREN

Drücken Sie auf , um das Gerät ein- oder auszuschalten. Das Instrument wird einen Eigendiagnostest vornehmen, während dem möglicherweise die Mitteilung „ovEr“ auf dem Anzeigefeld erscheint. Dies ist normal. Nach dem Ende des Aufwärmens verschwindet die Mitteilung wieder. Wenn der Eigendiagnostest abgeschlossen ist, erscheint die Temperatur in der unteren rechten Ecke des Anzeigefelds und das Gerät ist betriebsbereit. Tauchen Sie die Sonde etwa zur Hälfte in die Probelösung ein. Achten Sie darauf, dass die Sonde nach Möglichkeit keine festen Objekte in der Lösung berührt. Vermeiden Sie Luftblasen in der Nähe der Sonde. Wenn das Gerät nicht benutzt wird, schalten Sie es ab, um die Batterie zu schonen.

**HINWEIS:** Während einer Sauerstoffmessung muss die Sonde ungefähr 15 cm (1/2 Fuß) pro Sekunde bewegt werden, um für den Eigensauerstoffverbrauch durch den Sensor zu kompensieren. Bei Verwendung der Laborsonde 200-BOD jedoch einfach die selbstrührende Funktion der Sonde benutzen.

## MESSUNGS-BETRIEBSARTEN

Mit diesem Gerät können drei unterschiedliche Messungen durchgeführt werden:

- Temperatur** - Die aktuelle Temperatur der Lösung wird kontinuierlich angezeigt.
- Gelöster Sauerstoff in Prozent (%)** - Messwert der Sauerstoffsättigung in Prozent.
- Gelöster Sauerstoff in Teilen pro Million (ppm)** - Messwert des Sauerstoffs in ppm (mg/L).

Achten Sie genau auf die im LCD-Anzeigefeld ganz außen angezeigten Maßeinheiten, um die gewünschte Betriebsart zu bestimmen.

# KALIBRIERUNGSEINSTELLUNG









## Voraussetzungen

1. Der ungefähre Luftdruck (in Millibar [mBar]) der Region, für die gelöster Sauerstoff gemessen werden soll.
2. Der ungefähre Salzgehalt des Wassers, das analysiert werden soll. Süßwasser hat einen ungefähren Salzgehalt von Null. Meerwasser hat einen ungefähren Salzgehalt von 35 Teilen pro Tausend (ppt).
3. Für höchste Genauigkeit sollten Kalibrierungen bei einer Temperatur vorgenommen werden, die der Temperatur der Probe möglichst nahe kommt.

## Verfahren

1. Bei der Außenbereichssonde 5 bis 6 Tropfen sauberes Wasser (Leitungs-, destilliertes oder entionisiertes Wasser) auf den Schwamm in der Kalibrierungsflasche geben. Drehen Sie die Flasche um und lassen Sie überschüssiges Wasser aus der Flasche laufen. Der nasse Schwamm sorgt für eine zu 100 % mit Wasserdampf gesättigte Luftumgebung für die Sonde. Dies ist ideal für die Kalibrierung, den Transport und die Aufbewahrung der Sonde des Modells DO200. Zur Kalibrierung bleibt die Sonde in einer mit Wasserdampf gesättigten Luftatmosphäre und wird nicht eingetaucht.

Bei der Laborsonde einfach die gleiche Flasche, in der die Sonde mit ungefähr 2,5 cm (1 Zoll) Wasser am Boden der Flasche aufbewahrt wird, verwenden. Dies schafft für die Sonde eine zu 100 % mit Wasser gesättigte Umgebungsluft, was für die Kalibrierung und die Aufbewahrung der Sonde des Modells 200-BOD ideal ist. Für das Kalibrieren verbleibt die Sonde in der mit Wasser gesättigten Luftatmosphäre und wird nicht ganz eingetaucht.

2. Schieben Sie die Außenbereichssonde in die Kalibrierungsflasche. Achten Sie darauf, dass die Membrane den Schwamm nicht berührt.
3. Schalten Sie die DO200 durch Drücken auf die Taste  ein. Warten Sie 10 bis 15 Minuten, bis sich die Anzeigewerte für den gelösten Sauerstoff und die Temperatur stabilisiert haben..
4. Drücken Sie auf **CAL**.
5. Das LCD-Anzeigefeld fordert zur Eingabe des örtlichen Luftdrucks in mBar auf. Benutzen Sie die Tasten  und , um den angezeigten Luftdruckwert zu erhöhen bzw. zu verringern. Um Luftdruckeinheiten in mBar umzuwandeln, sehen Sie bitte im Abschnitt „Umrechnungen“ nach.
6. Wenn der richtige Luftdruckwert angezeigt wird, drücken Sie einmal auf , um den Kalibrierungswert in der unteren rechten Ecke des Anzeigefelds zu sehen. Sobald sich der Wert in der Hauptanzeige stabilisiert hat, drücken Sie erneut auf , um das Kompensationsverfahren für den Salzgehalt aufzurufen.
7. Das Anzeigefeld fordert zur Eingabe des ungefähren Salzgehalts des zu analysierenden Wassers auf. Benutzen Sie die Tasten  und , um den Kompensationswert für den Salzgehalt auf den Wert Ihrer Probe zu erhöhen bzw. zu verringern (zwischen 0 und 40 Teilen pro Tausend [ppt]). Wenn der korrekte Salzgehalt angezeigt wird, drücken Sie auf .
8. Das Gerät behält die Kalibrierung bei, selbst wenn es abgeschaltet ist. Es wird jedoch empfohlen, die Kalibrierung bei jeder Benutzung zu überprüfen und bei Bedarf eine erneute Kalibrierung vorzunehmen, um Abweichungen zu verhindern. Die Qualität der Messwerte für gelösten Sauerstoff hängt von der Kalibrierung ab.

## **WARTUNG UND PFLEGE DER SONDE**

Benutzen Sie den YSI-Sondenaufbereitungssatz (Artikelnummer 5238), um die Außenbereichsonden zu säubern. Verwenden Sie für die Laborsonde die im Membranen-Set 5908 enthaltene Schleifscheibe und folgen Sie, was das Schmirgeln betrifft, der im Handbuch der Sonde 200-BOD aufgegebenen Reinigungsanleitung. Zusätzlich zum Sondenaufbereitungssatz und der Schleifscheibe in Ihrem Membranen-Set 5908 können Sie eine chemische Reinigung versuchen. Mit einem Ammoniakhydroxid-Tauchbad werden die Elektroden chemisch gereinigt.

1. Entfernen Sie die Membrankappe und spülen Sie die Sonde mit sauberem Wasser ab (Leitungs-, destilliertes oder entionisiertes Wasser).
2. Schalten Sie das Gerät aus oder trennen Sie die Sonde ab.
3. Nehmen Sie entweder:
  - 14-prozentige Ammoniumhydroxidlösung (Laborstärke) und weichen Sie die Sonde 2 bis 3 Minuten in der Flüssigkeit ein; oder
  - 3-prozentige Ammoniaklösung (Haushaltsreinigungsstärke) und weichen Sie die Sonde über Nacht (8 bis 12 Stunden) in der Flüssigkeit ein.
4. Spülen Sie die Ammoniakhydroxid- bzw. die Ammoniaklösung von der Sonde ab.
5. Nehmen Sie Sandpapier (Körnungsnummer 400 nass/trocken; ist im Set 5238 und im Membranen-Set 5908 enthalten), um überschüssige Ablagerungen von der Sonde blank zu putzen (nass abzuschmirgeln).
6. Installieren Sie eine neue Membrankappe.

Verwenden Sie niemals Chemikalien oder Scheuermittel, die nicht von YSI empfohlen sind.

## **AUFFINDEN UND BESEITIGEN VON STÖRUNGEN**

<b>Auf der Hauptanzeige erscheint:</b>	<b>Mögliche Lösungen:</b>
„ovEr“ (über) oder „undr“ (unter)	<ul style="list-style-type: none"><li>• Überprüfen Sie die Membran und Elektrolytlösung.</li><li>• Reinigen Sie die Anode und Kathode.</li><li>• Schicken Sie das Produkt zwecks Service zurück.</li></ul>
<b>Auf der Sekundäranzeige erscheint:</b>	<b>Mögliche Lösungen:</b>
„undr“ (unter)	<ul style="list-style-type: none"><li>• Erwärmen Sie die Probe auf über -6,0 °C.</li><li>• Schicken Sie das Produkt zwecks Service zurück.</li></ul>
„ovEr“ (über)	<ul style="list-style-type: none"><li>• Kühlen Sie die Probe auf unter 46,0 °C ab.</li><li>• Schicken Sie das Produkt zwecks Service zurück.</li></ul>

## TECHNISCHE DATEN

Anzeige	Bereich	Genauigkeit	Auflösung
Gelöstes O <sub>2</sub> (ppm oder mg/L)	0 bis 20,00 ppm (mg/L)	±2 % des Messwerts oder ±2 % Luftsättigung, je nachdem, welcher Wert höher ist.	0,01 mg/L
Gelöstes O <sub>2</sub> in % Luftsättigung	0 bis 200,0 %	±2 % des Messwerts oder ±0,2 ppm, je nachdem, welcher Wert höher ist.	0,1 %
Temperatur °C (°F)	-6,0 bis 46,0 °C (21 bis 115 °F)	±0,3 °C ±1 Ziffer	0,1 °C

<b>Druckkompensation</b>	600 bis 1100 mBar (450 bis 825 mmHg)
<b>Salzgehaltkompensation</b>	Von 0,0 bis 40,0 Teile pro Tausend (ppt)
<b>ATC-Sonde</b>	Thermistor, 10 KΩ, bei 25 °C
<b>Sicherung der Kalibrierungsdaten</b>	Ja
<b>Audio-Feedback</b>	Ja, auf allen Tasten
<b>Stromquelle</b>	Eine 9 Volt-Batterie
<b>Betriebstemperatur</b>	0 bis 50 °C (32 bis 122 °F)
<b>Instrumentgehäuse</b>	Spritzwassergeschützt gemäß Schutzklasse IP 65
<b>Gewicht (mit Batterie)</b>	350 Gramm (0,75 lbs.)
<b>Abmessungen (B x T x H)</b>	186 mm x 70 mm x 37 mm (7,3 Zoll x 2,8 Zoll x 1,5 Zoll)

## UMRECHNUNGEN

Zum Umrechnen von:	Multiplizieren Sie mit:
Zoll (Inch) Hg in mBar	33,864
Zoll (Inch) Hg in mmHg	25,4
mmHg in mBar	1,333

## LISTE EMPFOHLENER ERSATZTEILE

Artikelnummer	BESCHREIBUNG
200-4	4 Meter (ca. 13 Fuß) lange Baugruppe bestehend aus Sonde und Kabel
200-10	10 Meter (ca. 33 Fuß) lange Baugruppe bestehend aus Sonde und Kabel
200-BOD	Baugruppe aus selbststrührender BOD Laborsonde und Kabel, mit Netzteil
280	DO-Tragekoffer, Hartschale
5908	Membransatz, 31,75 µm (1,25 mil) PE (605306), sechs Kappenmembranen und KCl-Lösung
480	Instrument-Tragetasche, weich

Artikel-Nr. 605368 • Zeichnung-Nr. A605368  
Revision C • September 2004

Die aktuellste Version dieses Handbuchs finden Sie unter [www.ysi.com/environmental](http://www.ysi.com/environmental)

## **GARANZIA**

Il misuratore YSI DO200 è coperto da garanzia per un anno dai difetti di manodopera e di materiali a partire dalla data di acquisto dell'utente finale. Le sonde e i cavi di YSI DO200 sono coperti da garanzia per un anno dai difetti di manodopera e di materiali a partire dalla data di acquisto dell'utente finale. Durante il periodo di validità della garanzia, YSI si assume la responsabilità di riparare o sostituire, a sua discrezione, gratuitamente, qualsiasi prodotto che YSI ritenga coperto da garanzia.

Per esercitare il diritto alla garanzia, scrivere o contattare il rappresentante di zona YSI, oppure il Servizio Assistenza Clienti a Yellow Springs, in Ohio. Inviare il prodotto e la prova d'acquisto, con trasporto a proprio carico, al Centro Assistenza autorizzato scelto da YSI. Una volta effettuata la riparazione o la sostituzione il prodotto verrà rinviato, sempre con trasporto a proprie spese. I prodotti riparati o sostituiti sono coperti da garanzia per il rimanente periodo di validità della garanzia originale, o per almeno 90 giorni dalla data di riparazione o sostituzione.

### **Limitazione della garanzia**

Questa garanzia non si applica ai prodotti YSI il cui danno o cattivo funzionamento è dovuto a: (i) installazione, messa in funzione o utilizzo del prodotto non conformi alle istruzioni scritte di YSI; (ii) abuso o uso improprio del prodotto; (iii) mancato rispetto delle istruzioni scritte di YSI o delle procedure standard dell'industria; (iv) eventuali riparazioni improprie del prodotto; (v) utilizzo da parte dell'utente di parti o componenti impropri o difettosi in fase di manutenzione o riparazione del prodotto; o (vi) eventuali modifiche del prodotto in modalità non espressamente autorizzate da YSI.

**QUESTA GARANZIA SOSTITUISCE TUTTE LE ALTRE, ESPLICITE O IMPLICITE, COMPRESSE QUELLE DI COMMERCIALIZZABILITÀ O IDONEITÀ AD UNO SCOPO PARTICOLARE. LA RESPONSABILITÀ DI YSI SECONDO QUESTA GARANZIA SI LIMITA ESCLUSIVAMENTE ALLA RIPARAZIONE O ALLA SOSTITUZIONE DEL PRODOTTO CHE COSTITUIRÀ L'UNICA ED ESCLUSIVA FORMA DI RIMBORSO PER EVENTUALI DIFETTI COPERTI DA QUESTA GARANZIA. IN NESSUN CASO YSI SARÀ RESPONSABILE DI EVENTUALI DANNI SPECIALI, INDIRETTI, INCIDENTALI O CONSEGUENZIALI DERIVANTI DA EVENTUALI DIFETTI DEL PRODOTTO COPERTO DA QUESTA GARANZIA.**

## **REFERENTE**

YSI Environmental, Inc. • 1725 Brannum Lane • Yellow Springs, Ohio, 45387 USA  
800-897-4151 • 937-767-7241 • Fax: 937-767-1058  
E-mail: [environmental@ysi.com](mailto:environmental@ysi.com) • sito Web: [www.ysi.com/environmental](http://www.ysi.com/environmental)



## INDICE

INTRODUZIONE GENERALE .....	2
ISPEZIONE INIZIALE.....	2
PRECAUZIONI .....	2
L'alloggiamento.....	2
La sonda .....	2
PREPARAZIONE DELLA SONDA.....	3
INSTALLAZIONE DELLA BATTERIA .....	3
IL TASTIERINO .....	3
IL DISPLAY LCD .....	4
PROCEDURE DI FUNZIONAMENTO .....	4
MODALITÀ DI MISURAZIONE .....	4
IMPOSTAZIONE DI CALIBRAZIONE .....	4
Requisiti .....	4
Procedura .....	5
MANUTENZIONE DELLA SONDA .....	5
INDIVIDUAZIONE E RISOLUZIONE DEI PROBLEMI .....	6
SPECIFICHE.....	6
CONVERSIONI .....	6
ELENCO DEI PEZZI DI RICAMBIO RACCOMANDATI .....	7

## **INTRODUZIONE GENERALE**

YSI DO200 è uno dei tre misuratori della linea di prodotti EcoSense® di YSI. DO200 è uno strumento preciso che misura l'ossigeno disciolto in % e in ppm (mg/l) e la temperatura. Un microprocessore incorporato memorizza, calcola e compensa tutti i parametri relativi alle determinazioni dell'DO (Ossigeno Disciolto) comprese le caratteristiche della temperatura dell'elettrodo DO.

Questa unità ha un alloggiamento IP65 a tenuta stagna. I tasti a sfioramento meccanico sono estremamente affidabili grazie alla conferma di azionamento tattile e acustica. Questo strumento utilizza una batteria da 9V. Quando viene ripristinata l'alimentazione non è richiesta alcuna ricalibrazione.

La parte anteriore dello strumento presenta un ampio display LCD che visualizza simultaneamente %, ppm dell'DO e la temperatura insieme ai prompt per l'utente e agli indicatori di modalità. L'unità avvisa l'utente attraverso procedure di calibrazione e di misurazione.

Le sonde da laboratorio e di campo DO200 utilizzano un elettrodo polarografico con comode membrane installate su un cappuccio a vite. Le sonde di campo 200-4 e 200-10 presentano una sonda per temperatura incorporata per la compensazione automatica della temperatura e un corpo in acciaio inossidabile per conferire maggiore pesantezza allo strumento. La sonda da laboratorio 200-BOD è dotata di alimentatore e include elettrodi auto-agitanti e sostituibili.

Altre caratteristiche includono una batteria a lunga durata e un filtraggio CA 50/60 Hz elevato. Questo strumento è universale e di facile utilizzo per applicazioni su campo, industriali e di laboratorio.

## **ISPEZIONE INIZIALE**

Disimballare accuratamente l'unità e gli accessori e valutare la presenza di eventuali danni da trasporto. Controllare se i pezzi ricevuti corrispondono ai materiali elencati nella distinta di spedizione. Informare immediatamente YSI di eventuali parti danneggiate o mancanti. Conservare tutti i materiali di imballaggio fino al corretto funzionamento.

## **PRECAUZIONI**

### **L'alloggiamento**

Sebbene il misuratore DO200 sia montato in un alloggiamento IP65 a tenuta stagna, NON utilizzarlo sott'acqua; il connettore non è resistente all'acqua. L'alloggiamento a tenuta stagna impedisce danni permanenti all'unità nel caso vengano accidentalmente a contatto con soluzioni non corrosive. In caso di immersione, seguire immediatamente queste fasi:

1. Asciugare il connettore se necessario e riposizionare la sonda per l'DO. Risciacquare accuratamente l'unità con acqua distillata. Dopo il risciacquo e l'asciugatura, ispezionare e pulire i connettori per rimuovere tutte le eventuali sostanze contaminanti che potrebbero danneggiare i collegamenti della sonda.
2. Attendere che l'unità e la sonda siano completamente asciutte prima di riprendere il funzionamento.
3. Se l'unità non funziona correttamente dopo le fasi 1 e 2, rivolgersi a YSI per eventuali riparazioni o per la sostituzione (vedere Garanzia).

### **Le sonde (di campo e da laboratorio)**

1. Le membrane hanno una durata utile maggiore se installate correttamente e regolarmente mantenute. Eventuali letture errate possono essere provocate da membrane danneggiate o sporche o dalla presenza di grosse bolle nel serbatoio dell'elettrolita. Se dovessero verificarsi letture irregolari o danni alla membrana, sostituire il cappuccio della membrana e la soluzione della Sonda dell'Ossigeno (nota anche come "Elettrolita della Sonda O2", cloruro di potassio o soluzione KCl). L'intervallo medio di sostituzione va da 4 a 8 settimane, anche se la durata utile potrebbe essere maggiore con una accurata manutenzione.

Ambienti difficili, come ad es. le acque reflue, potrebbero richiedere la sostituzione della membrana ogni 2 - 4 settimane. Potrebbero verificarsi letture irregolari se il cappuccio della membrana fosse inquinato da organismi che consumano ossigeno o che utilizzano l'ossigeno per le proprie funzioni, come i batteri e le alghe.

2. Il cloro, il biossido di zolfo, l'ossido nitrico e l'ossido nitroso possono influenzare i risultati della sonda poiché si comportano come l'ossigeno.
3. Evitare sostanze che potrebbero danneggiare i materiali della sonda come l'acido concentrato, i prodotti caustici e i solventi forti. I materiali della sonda includono acciaio inossidabile, resina epossidica e plastica ABS.
4. Mantenere il catodo d'oro della sonda pulito e a rugosità costante (quando correttamente mantenuto presenta una finitura opaca). Se annerito (dal contatto con alcuni gas), o platinato con argento (da uso prolungato con una membrana allentata o danneggiata), pulirlo, seguendo le istruzioni in "Manutenzione della sonda".
5. Per impedire alla membrana e all'elettrolita di essiccarsi, conservare la sonda di campo nel flacone di calibrazione con la spugnetta inumidita e la sonda da laboratorio in un flacone BOD con 2,5 cm (1 pollice) di acqua per tenerle in un ambiente di aria saturo.

## **PREPARAZIONE DELLA SONDA**

La sonda YSI DO200 è dotata di una membrana asciutta e protettiva. Per installare un nuovo cappuccio della membrana sulla sonda:

1. Svitare il cappuccio della membrana della sonda e smaltirlo.
2. Riempire un nuovo cappuccio con la Soluzione per Sonda Ossigeno. Prepararla in base alle istruzioni presenti sul flacone della soluzione.
3. Infilare il cappuccio della membrana riempito sul sensore.
4. Consentire un sufficiente riscaldamento prima dell'uso iniziale (10 - 15 min). Durante questo periodo potrebbe apparire sul display un messaggio di "ovEr". È una condizione normale. Una volta completato il riscaldamento il messaggio scomparirà.

## **INSTALLAZIONE DELLA BATTERIA**

Un messaggio iniziale di "LOW BAT" sul display indica un tempo residuo di funzionamento a batteria pari a circa un'ora, entro le specifiche. Sostituire la batteria quando sul display appare "LOW BAT".

Per la sostituzione, rimuovere i due coprivite della batteria, il dispositivo di copertura della batteria e l'o-ring. Sostituire la batteria da 9V. Sostituire il dispositivo di copertura della batteria e l'o-ring (accertarsi di ottenere l'allineamento corretto dell'o-ring per impedire una cattiva chiusura) e stringere i due coprivite della batteria per conservare l'ermeticità.

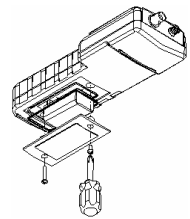


Figura 1.  
Installazione della batteria

## **IL TASTIERINO**

1. : accende e spegne l'unità.
2. **MODE (MODALITÀ)**: durante il funzionamento normale, alterna la visualizzazione da Ossigeno Disciolto in % di saturazione dell'aria a Ossigeno Disciolto in ppm (mg/l). in modalità Calibrazione, termina la calibrazione corrente e visualizza il successivo parametro di calibrazione.
3. **CAL**: durante il funzionamento normale, modifica la modalità da Normale a Calibrazione. Vedere Impostazione di Calibrazione.
4. : in Impostazione di Calibrazione, premere questo tasto per salvare il parametro corrente in memoria.
5. **Tasti Δ e ▽**: aumentano o diminuiscono il valore presente sul display come desiderato.

## IL DISPLAY LCD

1. **BAT**: indicatore di batteria scarica.
2. **CAL**: indicatore della modalità di Calibrazione.
3. **SAL ppt**: viene visualizzato durante la calibrazione quando all'utente viene richiesta la salinità approssimativa del campione in parti per migliaia (ppt).
4. **mBar**: viene visualizzato durante la calibrazione per richiedere all'utente la pressione barometrica.
5. Il display principale per i valori di ossigeno disciolto.
6. **%ppm**: indicatori dell'unità.
7. **°C**: display della temperatura.

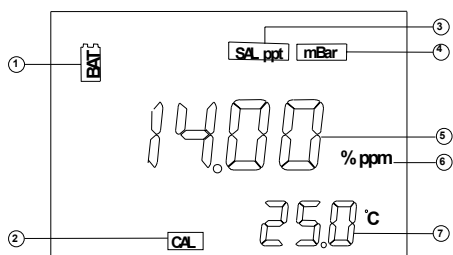



Figura 2. Display LCD

## PROCEDURE DI FUNZIONAMENTO

Premere  per accendere o spegnere l'unità. Lo strumento effettuerà un test di autodiagnostica, durante il quale potrebbe apparire sul display un messaggio di "ovEr". È una condizione normale. Una volta completato il riscaldamento il messaggio scomparirà. Dopo il completamento del test di autodiagnostica, la temperatura viene visualizzata in basso a destra sul display e l'unità è pronta per il funzionamento. Immergere la sonda a metà nella soluzione campione. Se possibile, non far entrare in contatto la sonda con eventuali oggetti solidi presenti nella soluzione. Non far formare bolle d'aria intorno alla sonda. Quando l'unità non è in uso, spegnerla per prolungare la durata utile della batteria.

**NOTA:** durante una misurazione di ossigeno, si deve spostare la sonda di circa 15 cm (1/2 piede) per secondo per ovviare al consumo intrinseco di ossigeno da parte del sensore. Quando si usa la sonda da laboratorio 200-BOD utilizzare la funzione autoagitante.

## MODALITÀ DI MISURAZIONE

Questa unità garantisce tre distinte misurazioni:

1. **Temperatura** – Viene visualizzata continuamente la temperatura della soluzione corrente.
2. **% di Ossigeno Disciolto** – Misurazione dell'ossigeno in percentuale di saturazione.
3. **ppm di Ossigeno Disciolto** – Misurazione dell'ossigeno in ppm (mg/l).

Osservare attentamente le unità visualizzate in piccolo sul display per determinare la modalità desiderata.

## IMPOSTAZIONE DI CALIBRAZIONE





### **Requisiti**

1. La pressione approssimativa (in millibar [mBar]) della regione in cui misurare l'ossigeno disciolto.
2. La salinità approssimativa dell'acqua da analizzare. L'acqua dolce ha salinità approssimativa pari a zero. L'acqua del mare ha una salinità approssimativa di 35 parti per migliaia (ppt).
3. Per una maggiore precisione, completare tutte le calibrazioni a una temperatura il più possibile vicino a quella del campione.

## Procedura

1. Per la sonda di campo, far cadere 5 - 6 gocce di acqua pulita (di rubinetto, distillata o deionizzata) sulla spugnetta all'interno del flacone di calibrazione. Capovolgere il flacone e lasciare che eventuali eccessi d'acqua fuoriescano. La spugnetta inumidita crea un ambiente saturo d'acqua al 100 % per la sonda, ideale per la calibrazione, il trasporto e l'immagazzinaggio della sonda Modello DO200. Per la calibrazione, la sonda rimane nell'atmosfera satura d'acqua e non viene immersa.

Per la sonda da laboratorio, utilizzare lo stesso flacone in cui la sonda è stata conservata con circa 25 mm (un pollice) di acqua sul fondo. In questo modo si viene a creare per la sonda un ambiente saturo d'acqua al 100 %, ideale per la calibrazione e la conservazione della sonda 200-BOD. Per la calibrazione, la sonda rimane nell'atmosfera satura d'acqua e non viene immersa.

2. Per la sonda di campo, far scivolare la sonda nel flacone di calibrazione. Accertarsi che la membrana non tocchi la spugnetta.
3. Accendere l'unità DO200 premendo . Attendere dai 10 ai 15 minuti per ottenere la stabilizzazione delle letture dell'ossigeno disciolto e della temperatura.
4. Premere **CAL**.
5. Il display LCD richiede la pressione locale in mBar. Utilizzare i tasti  $\Delta$  e  $\nabla$  per far aumentare o diminuire rispettivamente il valore della pressione. Vedere la sezione intitolata "Conversioni" per la conversione delle unità di pressione barometrica in mBar.
6. Quando viene visualizzata la pressione corretta, premere  per visualizzare il valore della calibrazione in basso a destra sul display. Quando il valore nel display principale si stabilizza, premere di nuovo  per passare alla procedura di compensazione della salinità.
7. Il display richiede la salinità approssimativa dell'acqua da analizzare. Utilizzare i tasti  $\Delta$  e  $\nabla$  per far aumentare o diminuire il valore della compensazione della salinità del campione (tra 0 a 40 parti per migliaia [ppt]). Quando viene visualizzata la salinità corretta, premere .
8. L'unità conserva la calibrazione anche se viene spenta. Tuttavia, si raccomanda di controllare la calibrazione prima di ogni singolo utilizzo e di ricalibrare quando necessario per impedire eventuali variazioni di risposta nel tempo (drift). I valori dell'ossigeno disciolto risultano corretti esclusivamente se la calibrazione è avvenuta regolarmente.

## **MANUTENZIONE DELLE SONDE**

Per pulire le sonde, utilizzare il kit di Ricondizionamento della sonda YSI (numero codice 5238). Per la sonda da laboratorio, utilizzare il disco per smerigliatura incluso nel kit membrana 5908 e seguire le istruzioni di pulizia descritte nel manuale della sonda 200-BOD relative alla smerigliatura. Oltre al Kit di Ricondizionamento e al disco per smerigliatura incluso nel kit membrana 5908, è possibile tentare una pulizia chimica. Per pulire chimicamente gli elettrodi, effettuare un'immersione in idrossido di ammonio.

1. Rimuovere il cappuccio della membrana e risciacquare la sonda con acqua pulita (di rubinetto, distillata o deionizzata).
2. Spegnerne l'unità, o scollegare la sonda.
3. Procurarsi:
  - o idrossido di ammonio in concentrazione da laboratorio al 14 % e immergere per 2 - 3 minuti
  - o ammoniaca ad uso domestico in concentrazione al 3 % e immergere per tutta la notte (8 - 12 ore)
4. Risciacquare l'idrossido di ammonio o l'ammoniaca dalla sonda.
5. Utilizzare carta abrasiva (grana 400 bagnata/asciutta, in dotazione con il kit 5238 e con il kit membrana 5908) per tamponare (umida) i depositi in eccesso dalla sonda.
6. Installare un nuovo cappuccio della membrana.

Non utilizzare prodotti chimici o abrasivi non raccomandati da YSI.

## INDIVIDUAZIONE E RISOLUZIONE DEI PROBLEMI

<b>Nel display principale appare:</b>	<b>Soluzioni possibili:</b>
“ovEr” o “undr”	<ul style="list-style-type: none"> <li>• Controllare la membrana e la soluzione dell'elettrolita.</li> <li>• Pulire l'anodo e il catodo.</li> <li>• Restituire il prodotto per l'assistenza.</li> </ul>
<b>Nel display secondario appare:</b>	<b>Soluzioni possibili:</b>
“undr”	<ul style="list-style-type: none"> <li>• Riscaldare il campione oltre i -6,0 °C.</li> <li>• Restituire il prodotto per l'assistenza.</li> </ul>
“ovEr”	<ul style="list-style-type: none"> <li>• Far raffreddare il campione al di sotto dei 46,0 °C.</li> <li>• Restituire il prodotto per l'assistenza.</li> </ul>

## SPECIFICHE

Display	Range	Accuratezza	Risoluzione
O <sub>2</sub> disciolto (ppm o mg/l)	da 0 a 20,00 ppm (mg/l)	±2 % della lettura o ±2 % della saturazione dell'aria, a seconda di quale delle due condizioni sia maggiore	0,01 mg/l
O <sub>2</sub> disciolto % sat. aria	da 0 a 200,0 %	±2 % della lettura o ±0,2 ppm, a seconda di quale delle due condizioni sia maggiore	0.1 %
Temperatura in °C (°F)	da -6,0 a 46,0 °C (da 21 a 115 °F)	±0,3 °C ±1	0,1 °C

<b>Compensazione della pressione</b>	da 600 a 1100 mBar (450 a 825 mm Hg)
<b>Compensazione della salinità</b>	Da 0,0 a 40,0 ppt
<b>Sonda ATC</b>	Termistore, 10KΩ, a 25 °C
<b>Backup di calibrazione</b>	Sì
<b>Feedback audio</b>	Sì, su tutti i tasti
<b>Fonte di alimentazione</b>	Una batteria da 9V
<b>Temperatura di funzionamento</b>	da 0 a 50 °C (da 32 a 122 °F)
<b>Alloggiamento dello strumento</b>	IP 65 a tenuta stagna
<b>Peso (con batteria)</b>	350 grammi (0,75 libbre)
<b>Dimensioni (L x P x A)</b>	186 mm x 70 mm x 37 mm (7,3 x 2,8 x 1,5 pollici)

## CONVERSIONI

<b>Per convertire:</b>	<b>Moltiplicare per:</b>
Pollici di Hg in mBar	33,864
Pollici di Hg in mm Hg	25,4
mm Hg in mBar	1,333

## **ELENCO DEI PEZZI DI RICAMBIO RACCOMANDATI**

<b>N. PEZZO</b>	<b>DESCRIZIONE</b>
200-4	Sonda di 4 metri (circa 13 piedi) e gruppo cavi
200-10	Sonda di 10 metri (circa 33 piedi) e gruppo cavi
200-BOD	Sonda da laboratorio BOD auto-agitante e gruppo cavi con alimentatore
280	Contenitore per trasporto strumenti DO, con lati rigidi
5908	Kit membrana, 31,75 µm (1,25 mil) PE (605306), sei membrane cappuccio e soluzione KCl
480	Scatola per il trasporto strumento, morbida

Pezzo N. 605368 • Disegno N. A605368  
Revisione C • Settembre 2004

Per la versione più recente di questo manuale, visitare [www.ysi.com/environmental](http://www.ysi.com/environmental)

Item #605368 • Drawing #A605368  
Revision C • September 2004  
For the latest version of this manual, visit [www.ysi.com/environmental](http://www.ysi.com/environmental)

Article n° 605368 • Dessin n° A605368  
Révision C • Septembre 2004  
Pour la dernière version de ce manuel, visitez [www.ysi.com/environmental](http://www.ysi.com/environmental)

Artículo N° 605368 • Ilustración N° A605368  
Revisión C • Septiembre de 2004  
Para la versión más reciente de este manual, visite [www.ysi.com/environmental](http://www.ysi.com/environmental)

Artikel-Nr. 605368 • Zeichnung-Nr. A605368  
Revision C • September 2004  
Die aktuellste Version dieses Handbuchs finden Sie unter [www.ysi.com/environmental](http://www.ysi.com/environmental)

Pezzo N. 605368 • Disegno N. A605368  
Revisione C • Settembre 2004  
Per la versione più recente di questo manuale, visitare [www.ysi.com/environmental](http://www.ysi.com/environmental)





## STANDARD OPERATING PROCEDURE

### VOLUNTEER RIVER MONITORING PROGRAM (VRMP)

#### METHODS FOR USING THE LAMOTTE DISSOLVED OXYGEN KIT (MODEL 7414/5860) & EASY READ® POCKET THERMOMETERS IN RIVERS AND STREAMS



**Note:** The mention of brand names does not constitute recommendation of a specific company.



## Volunteer River Monitoring Program

### Standard Operating Procedure Methods for Using the LaMotte (Model 7414/5860) Dissolved Oxygen Kit & Easy Read® Pocket Thermometers

**1. Applicability.** This standard operating procedure (SOP) is used by the Volunteer River Monitoring Program (VRMP) of the Maine Department of Environmental Protection's (DEP's) Bureau of Water Quality, Division of Environmental Assessment, Watershed Management Unit. It applies to the collection of dissolved oxygen (DO) from rivers and stream in Maine using LaMotte dissolved oxygen water quality monitoring kits (Model 7414/5860) and Easy Read® Pocket Thermometers (range: -5 to 50°C; divisions: 0.5°C; accuracy: 0.5°). Water temperature shall be measured at the same time as dissolved oxygen because it is critical towards helping calculate the percent saturation of dissolved oxygen in a sample.

**2. Purpose.** The purpose of this SOP is to provide standardized methods for volunteer groups to determine temperature and dissolved oxygen (DO) of rivers and streams as an instantaneous reading using LaMotte dissolved oxygen water quality monitoring kits (Model 7414/5860) and Easy Read® Pocket Thermometers (range: -5 to 50°C; divisions: 0.5°C; accuracy: 0.5°; *hereafter* referred to solely as “thermometer”).

### 3. Definitions

**A. MSDS.** Material Safety Data Sheet (a.k.a. SDS, Safety Data Sheet). Dated summary of a substance's characteristics including product identification, hazardous and non-hazardous ingredients, physical, fire, explosion, and reactivity data, health hazards, emergency first aid, spill and disposal procedures, precautionary measures, and special precautions.



**B. Hazardous Substance.** A substance that has ignitability, corrosivity, reactivity and/or toxicity characteristics requiring that special precautions be taken when working with it.

**C. LaMotte.** Manufacturer of water quality monitoring test kits including dissolved oxygen test kits.

**D. Easy Read®.** Brand of pocket thermometer.

### 4. Responsibilities

#### A. Volunteer Monitors & Volunteer Groups

- **Certification.** It is the responsibility of the individual obtaining this data to maintain current certification for the parameter(s) they collect if they wish their data to be



entered into the VRMP database. Training will be provided to volunteers on an annual basis by VRMP/DEP staff, and certification will last for one year from the date of training.

- **Data Recording.** It is the responsibility of the individual obtaining this data to record the results and additional qualifying information on current VRMP field sheets obtained from their affiliated watershed association or through the VRMP program of the DEP.
- **Data Quality Checks and Data Submission.** The data manager for the volunteer group will collect and enter volunteer field sheet data into the appropriate computer file, perform quality assurance checks (Refer to Section 5.10 of the Quality Assurance Program Plan), and submit data to the VRMP following protocols outlined in the volunteer group's latest sampling and analysis plan (SAP) that has been approved by the VRMP.

#### ***B. Volunteer River Monitoring Program (VRMP) Staff***

- **Oversight of Volunteer Groups and Volunteers.** VRMP staff will oversee volunteer groups and volunteers through a variety of ways including maintaining an up-to-date VRMP quality assurance program plan (QAPP); reviewing sampling and analysis plans (SAPs) of the volunteer groups; providing annual training/certification sessions for volunteers; conducting quality assurance checks on data submitted by volunteer groups and laboratories; and uploading data into the DEP's EGAD (Environmental and Geographic Analysis Database) database. These tasks are described in greater detail in the VRMP's latest QAPP.

### **5. Guidelines and procedures**

#### ***A. Safety.***

- Several reagents used in dissolved oxygen test kit are considered hazardous substances. These reagents include: Manganous Sulfate, Alkaline Potassium Iodine Azide, and Sulfuric Acid – all come with a Material Safety Data Sheet (MSDS). Please review the MSDS and the directions found in each kit carefully before using. The use of safety glasses is highly recommended.
- In addition, familiarize yourself with recommendations in sections “GENERAL SAFETY PRECAUTIONS” (page 14) and “USE PROPER ANALYTICAL TECHNIQUES” (page 15).
- Do not dispose fixed samples or reagents into a waterbody. Use up all reagents at the end of their ‘shelf life’ or dilute heavily with tap water and dispose of the same way other samples are disposed. Each batch of fixed samples and titrant should be collected in a disposable gallon milk jug, diluted with tap water and scattered over the



ground away from any wells. DO NOT dispose of any samples or reagents down your sink; explosive gases could form.

### ***B1. LaMotte Test Kit Preparation.***

- **First time use, beginning of field season, and prior to field sampling.** Conduct a full inspection of the kit to ensure completeness and valid chemical expiration dates. If any problems are detected, contact your group's coordinator or the VRMP for recommendations on how to resolve them.

### ***B2. Thermometer Preparation.***

- **First time use, beginning of field season, and prior to field sampling.** Inspect the thermometer for bubbles or gaps in the thermometer liquid that would hinder accurate temperature measurement. If bubbles or gaps are detected, contact the VRMP for recommendations on how to repair the thermometer.

### ***C1. Dissolved Oxygen Measurements.***

- **Sampling Period and Location.** Sampling period and site location information will be documented in SAPs (that require approval by the VRMP) that are submitted by the volunteer groups prior to the beginning of a sampling season. Detailed information regarding how volunteer groups are to obtain and document site location information can be found in VRMP SOP-02 [Methods for Selecting and Documenting Site Locations].
- **Sample Timing.** Dissolved oxygen data collected between dawn and 8 am are important for assessment of attainment of DO criteria within Maine's Water Quality Standards. But, except as naturally occurs, DO concentrations below the applicable DO criteria at any time of day signal non-attainment. If there are no DO concentrations below the criteria after 8 am, then data between dawn and 8 am must be collected to assess attainment of the criteria.
- **Dissolved Oxygen Measurements.**
  - (1) Record site location on data sheet.
  - (2) Follow manufacturer's instructions for proper DO sample analysis techniques (Appendix A, section "TEST PROCEDURE", pgs. 4 - 8).
  - (3) Page 7 of this section (Appendix A, section "TEST PROCEDURE") instructs the user how to compute the concentration (mg/L or ppm) of DO in the sample. Once the DO concentration has been determined, record that value on the data sheet.

### ***C2. Temperature Measurements.***

- **Sampling Period and Location.** See section C1.
- **Temperature Measurements.**
  - (1) Record site location on data sheet, if not done so already.



- (2) Place the thermometer close to where the DO sample was taken and hold there for at least 1 minute.
- (3) Record the temperature value on the data sheet.

#### **D. *Quality Control.***

- (1) At the beginning of each field season, all VRMP staff and VRMP volunteers who will collect dissolved oxygen data will have a training/refreshers session to (re)familiarize themselves with the contents of this SOP.
- (2) For every volunteer, a field duplicate shall be obtained for all parameters for at least 10% of their own sampling efforts. A field duplicate will be collected for every 10 samples monitored.
- (3) Refer to the VRMP quality assurance project plan (QAPP) for more QA/QC details.
- (4) Prior to measuring dissolved oxygen, the sodium thiosulfate shall be standardized. Follow manufacturer's instructions for standardization technique (Refer to Appendix A, "EPA Compliance", pg. 9). Record date and time of standardization on field data sheet.

#### **E. *Computation of % Saturation of Dissolved Oxygen.***

- (1) The VRMP will compute (using the DEP EGAD database) the % saturation of dissolved oxygen values for volunteer groups based upon the dissolved oxygen concentration and temperature data that the volunteers submit.
- (2) The specific conductance of freshwaters sampled by VRMP groups will be assumed to be less than 1000  $\mu\text{S}/\text{cm}$  in most cases, unless available data suggest otherwise, since it affects the % saturation of DO. If brackish tidal stream waters are to be sampled, conductivity data may need to be collected.
- (3) For volunteers interested in learning about this computation process and percent saturation tables, they can read more in Lewis (2006).

### **6. Equipment Care**

#### **A. *Start of field season.***

1. A full inspection and inventory of the kit including expiration dates of chemicals.

#### **B. *During field season.***

1. Keep kit out of direct sunlight as much as possible.
2. Store kit indoors in a cool, dry place out of direct sun. Keep out of the reach of children and pets.
3. Keep close track of chemical expiration dates and replace expired chemicals as necessary.



4. Remove plunger from titrator (syringe). Lightly coat rubber sides of plunger with lubricant (Vaseline or mineral oil will work) to keep rubber from drying, cracking or sticking. Refer to manufacturer's instructions (Appendix 1).
5. Rinse sampling bottle after sampling and return to kit with cap loosened or removed to allow for excess water to evaporate from bottle.

### C. End of field season.

1. Store kit indoors in a cool, dry place out of direct sun. Keep out of the reach of children and pets.
2. Remove plunger from titrator (syringe). Lightly coat rubber sides of plunger with lubricant (Vaseline or mineral oil will work) to keep rubber from drying, cracking or sticking. Refer to manufacturer's instructions (Appendix A).

## 7. References

Lewis, M. E. 2006. Chapter 6.2 Dissolved Oxygen *IN* U.S. Geological Survey, (variously dated), National field manual for the collection of water-quality data: U.S. Geological Survey Techniques of Water-Resources Investigations, book 9, chaps. A1-A9, available online at <http://pubs.water.usgs.gov/twri9A>.

Maine Department of Environmental Protection (MDEP). 2020. Maine Volunteer River Monitoring Program (VRMP) Quality Assurance Program Plan (QAPP). Portland, ME. DEPLW-0984.

## 8. Appendices

A. *LaMotte*. 2007. Dissolved Oxygen Instruction Manual (Code 7414/5860) Water Quality Test Kit. Chestertown, Maryland.

B. *D.O. Kit Reagent Shelf Lives*. The shelf life is based on the date of manufacture. The date of manufacture can be determined from the first 3 digits of the lot number on the lower left side of the label. The first two digits denote the week and the third number is a 1-digit code for year. For example, a lot number starting with 247 was made in the 24th week, which would be the first week in June, in the year 2007. If the chemical had a 2-year shelf life, it should be viable until the first week of June 2009. Keep in mind that shelf life is based on optimum storage conditions: 65-75 F, away from heat/freezing, high humidity, etc. Exposure to these conditions will decrease the shelf life. Below are the shelf lives for chemicals in LaMotte kit # 5860.

<u>Chemical</u>	<u>Shelf Life</u>
Sodium Thiosulfate (# 4169)	1 year
Starch Indicator (# 4170)	1.5 years
Mang. Sulf. (# 4167)	3 years
Alk. Pot. Iodide Azide (# 7166)	3 years
Sulfuric Acid (# 6141)	3 years



The following table provides the estimated week number for the first week of each month.

<u>Week</u>	<u>Month</u>	<u>Week</u>	<u>Month</u>	<u>Week</u>	<u>Month</u>
1	Jan	17	April/May	35	Aug/Sept
5	Jan/Feb	21	May/Jun	40	Oct
8	Feb/Mar	26	July	44	Oct/Nov
13	April	30	July/Aug	48	Nov



# Dissolved Oxygen

Water Quality Test Kit

*Instruction Manual • Code 7414/5860*

 **LaMotte**





# INTRODUCTION

Aquatic animals need dissolved oxygen to live. Fish, invertebrates, plants, and aerobic bacteria all require oxygen for respiration. Oxygen dissolves readily into water from the atmosphere until the water is saturated. Once dissolved in the water, the oxygen diffuses very slowly and distribution depends on the movement of the aerated water. Oxygen is also produced by aquatic plants, algae, and phytoplankton as a by-product of photosynthesis.

The amount of oxygen required varies according to species and stage of life. Dissolved Oxygen levels below 3 ppm are stressful to most aquatic organisms. Dissolved Oxygen levels below 2 or 1 ppm will not support fish. Levels of 5 to 6 ppm are usually required for growth and activity.

This test kit uses the azide modification of the Winkler method for determining dissolved oxygen.

## TABLE OF CONTENTS

	Page
Kit Contents.....	2
Test Procedure	
Part 1: Collecting a Water Sample .....	3
Part 2: Adding the Reagents .....	4
Part 3: Titration.....	5
EPA Compliance.....	8
Dissolved Oxygen Fact Sheet.....	10
General Safety Precautions.....	13
Use Proper Analytical Techniques.....	14
Material Safety Data Sheets .....	15
Kit Diagrams.....	21
Short Form Instructions .....	Back Cover

WARNING! This set contains chemicals that may be harmful if misused. Read cautions on individual containers carefully. Not to be used by children except under adult supervision

## KIT CONTENTS

QUANTITY	CONTENTS	CODE
30 mL	*Manganous Sulfate Solution	*4167-G
30 mL	*Alkaline Potassium Iodide Azide	*7166-G
50 g	*Sulfamic Acid Powder (7414 Kit)	*6286-H
30 mL	*Sulfuric Acid, 1:1 (5860 Kit)	*6141WT-G
60 mL	*Sodium Thiosulfate, 0.025N	*4169-H
30 mL	Starch Indicator Solution	4170WT-G
1	Spoon, 1.0 g, plastic (7414 Kit)	0697
1	Direct Reading Titrator	0377
1	Test Tube, 5-10-12.9-15-20-25 mL, glass, w/cap	0608
1	Water Sampling Bottle, 60 mL, glass	0688-DO


**\*WARNING:** Reagents marked with a \* are considered to be potential health hazards. To view or print a Material Safety Data Sheet (MSDS) for these reagents see MSDS CD or [www.lamotte.com](http://www.lamotte.com). To obtain a printed copy, contact LaMotte by email, phone or fax.

To order individual reagents or test kit components, use the specified code numbers.

# TEST PROCEDURE


## PART 1 - COLLECTING THE WATER SAMPLE

**1.**



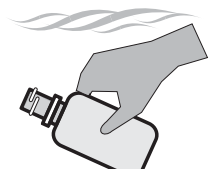
Rinse the Water Sampling Bottle (0688-DO) with the sample water.

**2.**



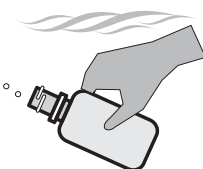
Tightly cap the bottle, and submerge it to the desired depth.

**3.**



Remove the cap and allow the bottle to fill.

**4.**



Tap the sides of the bottle to dislodge any air bubbles.

**5.**



Replace the cap while the bottle is still submerged.

**6.**



Retrieve the bottle and make sure that no air bubbles are trapped inside.

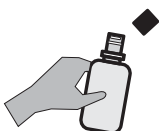
# TEST PROCEDURE

## PART 2 - ADDING THE REAGENTS

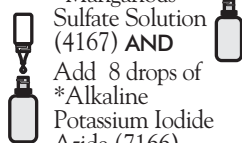
### NOTE:

Be careful not to introduce air into the sample while adding the reagents.

1. Remove the cap from the bottle.



2. Immediately add 8 drops of \*Manganous Sulfate Solution (4167) AND Add 8 drops of \*Alkaline Potassium Iodide Azide (7166).



3.



Cap the bottle and mix by inverting several times. A precipitate will form.

4.



Allow the precipitate to settle below the shoulder of the bottle.

5.

#### For Kit Code 7414:

Immediately use the 1.0 g spoon (0697) to add one level measure of \*Sulfamic Acid Powder (6286).



OR

#### For Kit Code 5860:

Add 8 drops of \*Sulfuric Acid, 1:1 (6141WT).



6. Cap and gently invert the bottle to mix the contents until the precipitate and the reagent have totally dissolved. The solution will be clear yellow to orange if the sample contains dissolved oxygen.



**NOTE:** At this point the sample has been "fixed" and contact between the sample and the atmosphere will not affect the test result. Samples may be held at this point and titrated later.

# TEST PROCEDURE

## PART 3 - THE TITRATION

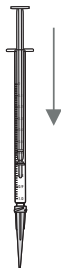
**1.**

Fill the titration tube (0608) to the 20 mL line with the fixed sample. Cap the tube.



**2.**

Depress plunger of the Titrator (0377).



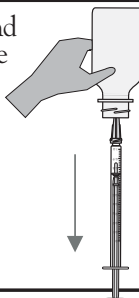
**3.**

Insert the Titrator into the plug in the top of the \*Sodium Thiosulfate, 0.025N (4169) titrating solution.



**4.**

Invert the bottle and slowly withdraw the plunger until the large ring on the plunger is opposite the zero (0) line on the scale.

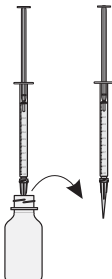


**NOTE:**

If small air bubbles appear in the Titrator barrel, expel them by partially filling the barrel and pumping the titration solution back into the reagent container. Repeat until bubble disappears.

**5.**

Turn the bottle upright and remove the Titrator.



**NOTE:**

If the sample is a very pale yellow, go to Step 9.



*continued . . .*

## TEST PROCEDURE

**6.**

Insert the tip of the Titrator into the opening of the titration tube cap.



**7.**

Slowly depress the plunger to dispense the titrating solution until the yellow-brown color changes to a very pale yellow. Gently swirl the tube during the titration to mix the contents.



**8.**

Carefully remove the Titrator and cap. Do not disturb the Titrator plunger.



**9.**

Add 8 drops of Starch Indicator Solution (4170WT). The sample should turn blue.



**10.**

Cap the titration tube. Insert the tip of the Titrator into the opening of the titration tube cap.



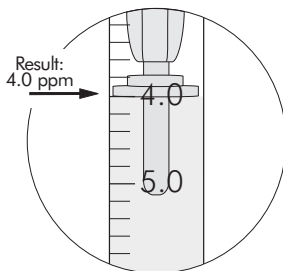
**11.**

Continue titrating until the blue color disappears and the solution becomes colorless.



**12.**

Read the test result directly from the scale where the large ring on the Titrator meets the Titrator barrel. Record as ppm Dissolved Oxygen. Each minor division on the Titrator scale equals 0.2 ppm.



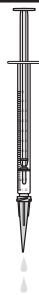
## TEST PROCEDURE

### NOTE:

If the plunger ring reaches the bottom line on the scale (10 ppm) before the endpoint color change occurs, refill the Titrator and continue the titration. Include the value of the original amount of reagent dispensed (10 ppm) when recording the test result.

### NOTE:

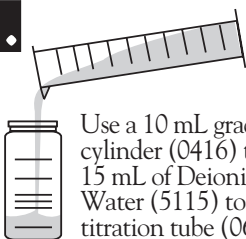
When testing is complete, discard titrating solution in Titrator. Rinse Titrator and titration tube thoroughly. DO NOT remove plunger or adapter tip.







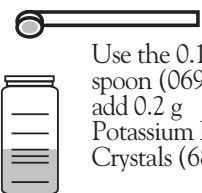
## EPA COMPLIANCE

To qualify as an EPA accepted test, and to achieve the greatest accuracy, the Sodium Thiosulfate Solution, 0.025N (4169) must be standardized daily. This procedure follows Standard Methods for the Examination of Water and Wastewater. Numbers in ( ) are for LaMotte products. These products are not included in this kit but can be ordered from LaMotte Company by using the specified code number.

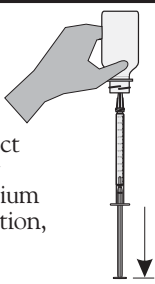
**1.**  Use a 10 mL graduated cylinder (0416) to add 15 mL of Deionized Water (5115) to the titration tube (0608).

**2.**  Use a Direct Reading Titrator, 0-1 Range (1.0 mL capacity) (0376) to add 2 mL of Potassium Bi-iodate (7346).

**3.**  Add 2 drops of Sulfuric Acid, 5N (8517WT).

**4.**  Use the 0.1 g spoon (0699) to add 0.2 g Potassium Iodide Crystals (6809).

**5.** Swirl to dissolve. Solution will turn yellowish brown. 

**6.**  Fill another Direct Reading Titrator (0376) with Sodium Thiosulfate Solution, 0.025N (4169).

# EPA COMPLIANCE

**7.**

While gently swirling the tube, add Sodium Thiosulfate, 0.025N until the color fades to pale yellow. It will be necessary to refill the Direct Reading Titrator.



**8.**

Add 3 drops of Starch Indicator Solution (4170WT). The solution will turn blue.



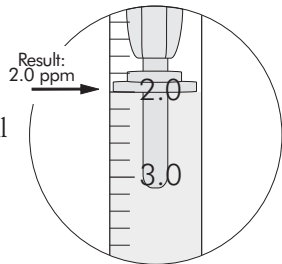
**9.**

Continue adding Sodium Thiosulfate, 0.025N until the blue color disappears and the solution is colorless.



**10.**

Read the test result directly from the scale where the large ring on the Titrator meets the Titrator barrel. Include the value of the original amount dispensed (1 mL). If the reading is 2.0 +/-0.1 mL, the Sodium Thiosulfate, 0.025N (4169) is satisfactory. If not, discard and replace with new reagent.



# DISSOLVED OXYGEN FACT SHEET

Oxygen is critical to the survival of aquatic plants and animals, and a shortage of dissolved oxygen is not only a sign of pollution, it is harmful to fish. Some aquatic species are more sensitive to oxygen depletion than others, but some general guidelines to consider when analyzing test results are:

5–6 ppm Sufficient for most species

<3 ppm Stressful to most aquatic species

<2 ppm Fatal to most species

Because of its importance to the fish's survival, aquaculturists, or "fish farmers," and aquarists use the dissolved oxygen test as a primary indicator of their system's ability to support healthy fish.

## WHERE DOES THE OXYGEN COME FROM?

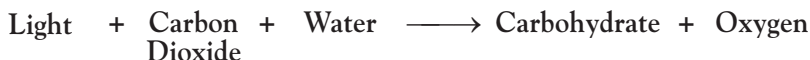
The oxygen found in water comes from many sources, but the largest source is oxygen absorbed from the atmosphere. Wave action and splashing allows more oxygen to be absorbed into the water. A second major source of oxygen is aquatic plants, including algae; during photosynthesis plants remove carbon dioxide from the water and replace it with oxygen.

### Absorption

Oxygen is continuously moving between the water and surrounding air. The direction and speed of this movement is dependent upon the amount of contact between the air and water. A tumbling mountain stream or windswept, wave-covered lake, where more of the water's surface is exposed to the air, will absorb more oxygen from the atmosphere than a calm, smooth body of water. This is the idea behind aerators: by creating bubbles and waves the surface area is increased and more oxygen can enter the water.

### Photosynthesis

In the leaves of plants, one of the most important chemical processes on Earth is constantly occurring: photosynthesis. During daylight, plants constantly take carbon dioxide from the air, and in the presence of water convert it to oxygen and carbohydrates, which are used to produce additional plant material. Since photosynthesis requires light, plants do not photosynthesize at night, so no oxygen is produced. Chemically, the photosynthesis reaction can be written as:



## WHERE DOES THE OXYGEN GO?

Once in the water, oxygen is used by the aquatic life. Fish and other aquatic animals need oxygen to breathe or respire. Oxygen is also consumed by bacteria to decay, or decompose, dead plants and animals.

### Respiration

All animals, whether on land or underwater, need oxygen to respire, grow and survive. Plants and animals respire throughout the night and day, consuming oxygen and producing carbon dioxide, which is then used by plants during photosynthesis.

### Decomposition

All plant and animal waste eventually decomposes, whether it is from living animals or dead plants and animals. In the decomposition process, bacteria use oxygen to oxidize, or chemically alter, the material to break it down to its component parts. Some aquatic systems may undergo extreme amounts of oxidation, leaving no oxygen for the living organisms, which eventually leave or suffocate.

## OTHER FACTORS

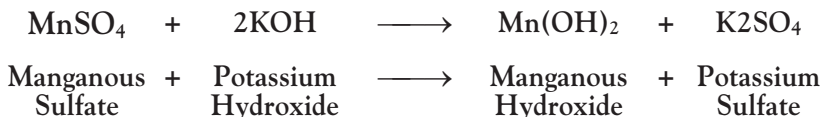
The oxygen level of a water system is not only dependent on production and consumption. Many other factors work together to determine the potential oxygen level, including:

- **Salt vs. fresh water** - Fresh water can hold more oxygen than salt water.
- **Temperature** - Cold water can hold more oxygen than warm water.
- **Atmospheric pressure (Altitude)** - The greater the atmospheric pressure the more oxygen the water will hold.

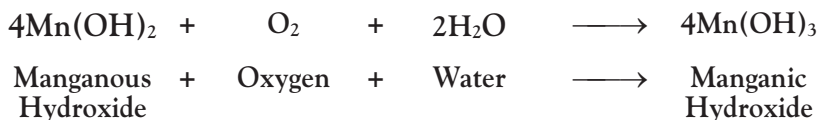
## TESTING DISSOLVED OXYGEN

Dissolved oxygen is often tested using the Azide modification of the Winkler method. When testing dissolved oxygen it is critical not to introduce additional oxygen into the sample. Many people avoid this problem by filling the sample bottle all the way and allowing the water to overflow for one minute before capping.

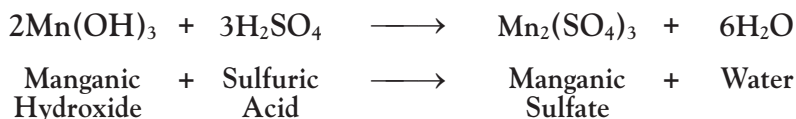
The first step in a DO titration is the addition of Manganous Sulfate Solution (4167) and Alkaline Potassium Iodide Azide Solution (7166). These reagents react to form a white precipitate, or floc, of manganous hydroxide,  $Mn(OH)_2$ . Chemically, this reaction can be written as:



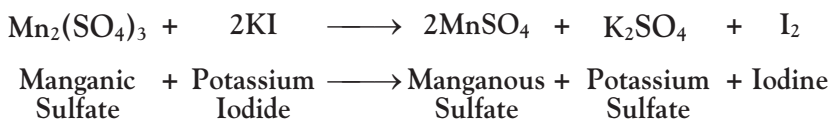
Immediately upon formation of the precipitate, the oxygen in the water oxidizes an equivalent amount of the manganous hydroxide to brown-colored manganic hydroxide. For every molecule of oxygen in the water, four molecules of manganous hydroxide are converted to manganic hydroxide. Chemically, this reaction can be written as:



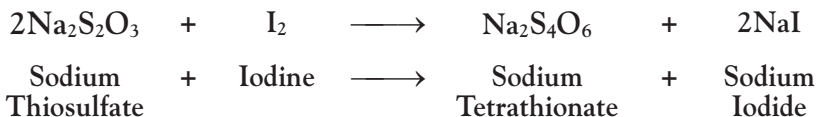
After the brown precipitate is formed, a strong acid, such as Sulfamic Acid Powder (6286) or Sulfuric Acid, 1:1 (6141) is added to the sample. The acid converts the manganic hydroxide to manganic sulfate. At this point the sample is considered “fixed” and concern for additional oxygen being introduced into the sample is reduced. Chemically, this reaction can be written as:



Simultaneously, iodine from the potassium iodide in the Alkaline Potassium Iodide Azide Solution is oxidized by manganic sulfate, releasing free iodine into the water. Since the manganic sulfate for this reaction comes from the reaction between the manganous hydroxide and oxygen, the amount of iodine released is directly proportional to the amount of oxygen present in the original sample. The release of free iodine is indicated by the sample turning a yellow-brown color. Chemically, this reaction can be written as:



The final stage in the Winkler titration is the addition of sodium thiosulfate. The sodium thiosulfate reacts with the free iodine to produce sodium iodide. When all of the iodine has been converted the sample changes from yellow-brown to colorless. Often a starch indicator is added to enhance the final endpoint. Chemically, this reaction can be written as:



# GENERAL SAFETY PRECAUTIONS

1.



Store the test kit in a cool, dry area.

2.



Read all instructions and note precautions before performing the test procedure.

3.

Read the labels on all reagent bottles. Note warnings and first aid information. Read all Material Safety Data Sheets.



4.



Keep all equipment and reagent chemicals out of the reach of young children.

5.

Avoid contact between reagent chemicals and skin, eyes, nose, and mouth.



6.

Wear safety glasses when performing test procedures.



7.



In the event of an accident or suspected poisoning, immediately call the Poison Center phone number in the front of your local telephone directory or call a physician. Additional information for all LaMotte reagents is available in the United States, Canada, Puerto Rico, and the US Virgin Islands from Chem-Tel by calling 1-800-255-3924. For other areas, call 813-248-0585 collect to contact Chem-Tel's International access number. Each reagent can be identified by the four digit number listed on the upper left corner of the reagent label, in the contents list and in the test procedures.

## USE PROPER ANALYTICAL TECHNIQUES

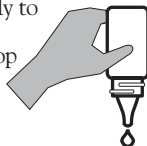
1.



Use test tube caps or stoppers, not your fingers, to cover tubes during shaking or mixing.

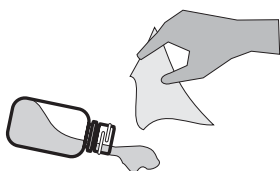
2.

Hold dropper bottles vertically upside-down, and not at an angle, when dispensing a reagent. Squeeze the bottle gently to dispense the reagent one drop at a time.



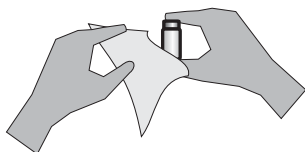
3.

Wipe up any reagent chemical spills immediately.



4.

Thoroughly rinse test tubes before and after each test.



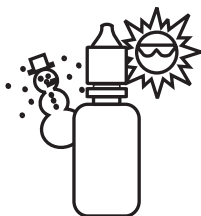
5.

Tightly close all containers immediately after use. Do not interchange caps from containers.



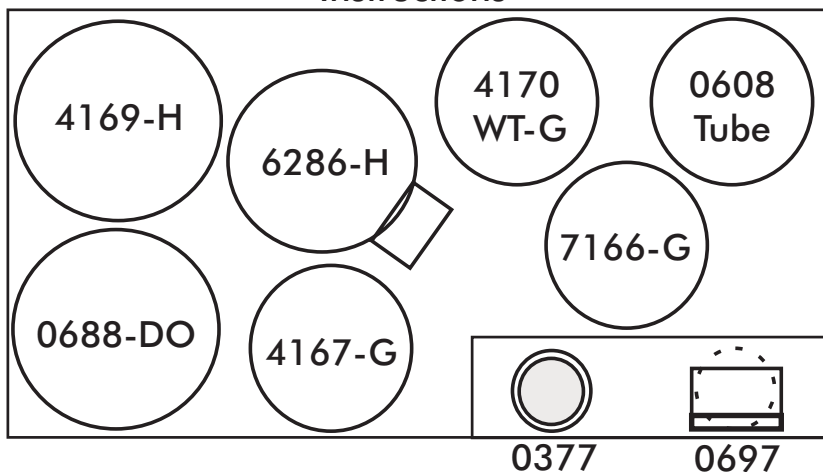
6.

Avoid prolonged exposure of equipment and reagents to direct sunlight. Protect reagents from extremes of temperature.



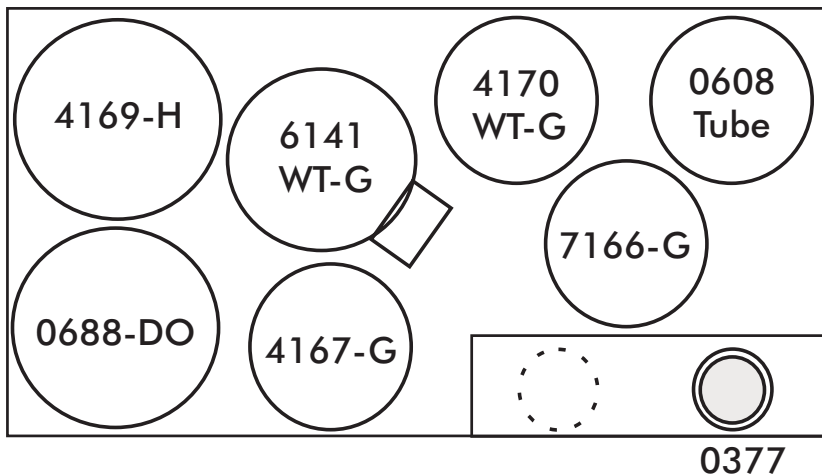
# DISSOLVED OXYGEN KIT · CODE 7414

## Instructions



# DISSOLVED OXYGEN KIT · CODE 5860

## Instructions









## SHORT FORM INSTRUCTIONS

Read all instructions before performing test. Use this guide as a quick reference.

1. Fill Water Sampling Bottle (0688-DO).
2. Add 8 drops of \*Manganous Sulfate Solution (4167).
3. Add 8 drops of \*Alkaline Potassium Iodide Azide (7166).
4. Cap and mix.
5. Allow precipitate to settle.
6. Use the 1.0 g spoon to add \*Sulfamic Acid Powder (6286) or add 8 drops of Sulfuric Acid, 1:1 (6141WT).
7. Cap and mix until reagent and precipitate dissolve.
8. Fill test tube (0608) to the 20 mL line.
9. Fill Titrator with \*Sodium Thiosulfate, 0.025N (4169).
10. Titrate until sample color is pale yellow. DO NOT DISTURB TITRATOR.
11. Add 8 drops of Starch Indicator (4170WT).
12. Continue titration until blue color just disappears and solution is colorless.
13. Read result in ppm Dissolved Oxygen.

### LaMOTTE COMPANY

Helping People Solve Analytical Challenges®

PO Box 329 • Chestertown • Maryland • 21620 • USA  
800-344-3100 • 410-778-3100 (Outside U.S.A.) • Fax 410-778-6394  
Visit us on the web at [www.lamotte.com](http://www.lamotte.com)





## STANDARD OPERATING PROCEDURE

### VOLUNTEER RIVER MONITORING PROGRAM (VRMP)

#### METHODS FOR USING THE LAMOTTE DISSOLVED OXYGEN KIT (MODEL 5856) & EASY READ® POCKET THERMOMETERS IN RIVERS AND STREAMS



**Note:** The mention of brand names does not constitute recommendation of a specific company.



**Volunteer River Monitoring Program**  
**Standard Operating Procedure**  
**Methods for Using**  
**the LaMotte (Model 5856) Dissolved Oxygen Kit**  
**& Easy Read® Pocket Thermometers**

**1. Applicability.** This standard operating procedure (SOP) is used by the Volunteer River Monitoring Program (VRMP) of the Maine Department of Environmental Protection’s (DEP’s) Bureau of Water Quality, Division of Environmental Assessment, Watershed Management Unit. It applies to the collection of dissolved oxygen (DO) from rivers and stream in Maine using LaMotte dissolved oxygen water quality monitoring kits (Model 5856) and Easy Read® Pocket Thermometers (range: -5 to 50°C; divisions: 0.5°C; accuracy: 0.5°). Water temperature shall be measured at the same time as dissolved oxygen because it is critical towards helping calculate the percent saturation of dissolved oxygen in a sample.

**2. Purpose.** The purpose of this SOP is to provide standardized methods for volunteer groups to determine temperature and dissolved oxygen (DO) of rivers and streams as an instantaneous reading using LaMotte dissolved oxygen water quality monitoring kits (Model 5856) and Easy Read® Pocket Thermometers (range: -5 to 50°C; divisions: 0.5°C; accuracy: 0.5°; *hereafter* referred to solely as “thermometer”).

**3. Definitions**

**A. MSDS.** Material Safety Data Sheet (a.k.a. SDS, Safety Data Sheet). Dated summary of a substance's characteristics including product identification, hazardous and non-hazardous ingredients, physical, fire, explosion, and reactivity data, health hazards, emergency first aid, spill and disposal procedures, precautionary measures, and special precautions.



**B. Hazardous Substance.** A substance that has ignitability, corrosivity, reactivity and/or toxicity characteristics requiring that special precautions be taken when working with it.

**C. LaMotte.** Manufacturer of water quality monitoring test kits including dissolved oxygen test kits.

**D. Easy Read®.** Brand of pocket thermometer.

**4. Responsibilities**

**A. Volunteer Monitors & Volunteer Groups**



- **Certification.** It is the responsibility of the individual obtaining this data to maintain current certification for the parameter(s) they collect if they wish their data to be entered into the VRMP database. Training will be provided to volunteers on an annual basis by VRMP/DEP staff, and certification will last for one year from the date of training.
- **Data Recording.** It is the responsibility of the individual obtaining this data to record the results and additional qualifying information on current VRMP field sheets obtained from their affiliated watershed association or through the VRMP program of the DEP.
- **Data Quality Checks and Data Submission.** The data manager for the volunteer group will collect and enter volunteer field sheet data into the appropriate computer file, perform quality assurance checks (Refer to Section 5.10 of the Quality Assurance Program Plan), and submit data to the VRMP following protocols outlined in the volunteer group's latest sampling and analysis plan (SAP) that has been approved by the VRMP.

#### ***B. Volunteer River Monitoring Program (VRMP) Staff***

- **Oversight of Volunteer Groups and Volunteers.** VRMP staff will oversee volunteer groups and volunteers through a variety of ways including maintaining an up-to-date VRMP quality assurance program plan (QAPP); reviewing sampling and analysis plans (SAPs) of the volunteer groups; providing annual training/certification sessions for volunteers; conducting quality assurance checks on data submitted by volunteer groups and laboratories; and uploading data into the DEP's EGAD (Environmental and Geographic Analysis Database) database. These tasks are described in greater detail in the VRMP's latest QAPP.

### **5. Guidelines and procedures**

#### ***A. Safety.***

- Several reagents used in dissolved oxygen test kit are considered hazardous substances. These reagents include: Manganous Sulfate, Alkaline Potassium Iodine Azide, and Sulfuric Acid – all come with a Material Safety Data Sheet (MSDS). Please review the MSDS and the directions found in each kit carefully before using. The use of safety glasses is highly recommended.
- Do not dispose fixed samples or reagents into the waterbody. Use up all reagents at the end of their 'shelf life' or heavily dilute with tap water and dispose of the same way as other samples. Each batch of fixed samples and titrant should be collected in a disposable gallon milk jug, diluted with tap water and scattered over the ground away from any wells. DO NOT dispose of any samples or reagents down your sink; explosive gases could form.



### ***B1. LaMotte Test Kit Preparation.***

- **First time use, beginning of field season, and prior to field sampling.** Conduct a full inspection of the kit to ensure completeness and valid chemical expiration dates. If any problems are detected, contact your group’s coordinator or the VRMP for recommendations on how to resolve them.

### ***B2. Thermometer Preparation.***

- **First time use, beginning of field season, and prior to field sampling.** Inspect the thermometer for bubbles or gaps in the thermometer liquid that would hinder accurate temperature measurement. If bubbles or gaps are detected, contact the VRMP for recommendations on how to repair the thermometer.

### ***C1. Dissolved Oxygen Measurements.***

- **Sampling Period and Location.** Sampling period and site location information will be documented in SAPs (that require approval by the VRMP) that are submitted by the volunteer groups prior to the beginning of a sampling season. Detailed information regarding how volunteer groups are to obtain and document site location information can be found in VRMP SOP-02 [Documenting Site Location].
- **Sample Timing.** Dissolved oxygen data collected between dawn and 8 am are important for assessment of attainment of DO criteria within Maine’s Water Quality Standards. But, except as naturally occurs, DO concentrations below the applicable DO criteria at any time of day signal non-attainment. If there are no DO concentrations below the criteria after 8 am, then data between dawn and 8 am must be collected to assess attainment of the criteria
- **Dissolved Oxygen Measurements.**
  - (1) Record site location on data sheet.
  - (2) Follow manufacturer’s instructions for proper DO sample analysis techniques (Appendix A, sections, “COLLECTION & TREATMENT OF THE WATER SAMPLE”, “DIRECT READING TITRATOR INSTRUCTIONS”, and “TEST PROCEDURE”).

### ***C2. Temperature Measurements.***

- **Sampling Period and Location.** See section C1.
- **Temperature Measurements.**
  - (1) Record site location on data sheet, if not done so already.
  - (2) Place the thermometer close to where the DO sample was taken and hold there for at least 1 minute.
  - (3) Record the temperature value on the data sheet.





#### **D. *Quality Control.***

- (1) At the beginning of each field season, all VRMP staff and VRMP volunteers who will collect dissolved oxygen data will have a training/refresher session to (re)familiarize themselves with the contents of this SOP.
- (2) For every volunteer, a field duplicate shall be obtained for all parameters for at least 10% of their own sampling efforts. A field duplicate will be collected for every 10 samples monitored.
- (3) Refer to the VRMP quality assurance project plan (QAPP) for more QA/QC details.
- (4) Prior to measuring dissolved oxygen, the sodium thiosulfate shall be standardized once a month. Follow manufacturer's instructions for standardization technique (Refer to Appendix B, section, "DISSOLVED OXYGEN CHECK STANDARD PROCEDURE"). Record date and time of standardization on field data sheet.

#### **E. *Computation of % Saturation of Dissolved Oxygen.***

- (1) The VRMP will compute (using the DEP EGAD database) the % saturation of dissolved oxygen values for volunteer groups based upon the dissolved oxygen concentration and temperature data that the volunteers submit.
- (2) The specific conductance of freshwaters sampled by VRMP groups will be assumed to be less than 1000  $\mu\text{S}/\text{cm}$  in most cases, unless available data suggest otherwise, since it affects the % saturation of DO. If brackish tidal stream waters are to be sampled, conductivity data may need to be collected.
- (3) For volunteers interested in learning about this computation process and percent saturation tables, they can read more in Lewis (2006).

### **6. Equipment Care**

#### **A. *Start of field season.***

1. A full inspection and inventory of the kit including expiration dates of chemicals.

#### **B. *During field season.***

1. Keep kit out of direct sunlight as much as possible.
2. Store kit indoors in a cool, dry place out of direct sun. Keep out of the reach of children and pets.
3. Keep close track of chemical expiration dates and replace expired chemicals as necessary.
4. Remove plunger from titrator (syringe). Lightly coat rubber sides of plunger with lubricant (Vaseline or mineral oil will work) to keep rubber from drying, cracking or sticking. Refer to manufacturer's instructions (Appendix 1).
5. Rinse sampling bottle after sampling and return to kit with cap loosened or removed to allow for excess water to evaporate from bottle.



### C. End of field season.

1. Store kit indoors in a cool, dry place out of direct sun. Keep out of the reach of children and pets.
2. Remove plunger from titrator (syringe). Lightly coat rubber sides of plunger with lubricant (Vaseline or mineral oil will work) to keep rubber from drying, cracking or sticking. Refer to manufacturer's instructions (Appendix 1).

## 7. References

Lewis, M. E. 2006. Chapter 6.2 Dissolved Oxygen *IN* U.S. Geological Survey, (variously dated), National field manual for the collection of water-quality data: U.S. Geological Survey Techniques of Water-Resources Investigations, book 9, chaps. A1-A9, available online at <http://pubs.water.usgs.gov/twri9A>.

Maine Department of Environmental Protection (MDEP). 2020. Maine Volunteer River Monitoring Program (VRMP) Quality Assurance Program Plan (QAPP). Portland, ME. DEPLW-0984.

## 8. Appendices

A. *LaMotte. 2007.* Dissolved Oxygen Instruction Manual (Code 5856) Water Quality Test Kit. Chestertown, Maryland.

B. *D.O. Kit Reagent Shelf Lives.* The shelf life is based on the date of manufacture. The date of manufacture can be determined from the first 3 digits of the lot number on the lower left side of the label. The first two digits denote the week and the third number is a 1-digit code for year. For example, a lot number starting with 247 was made in the 24th week, which would be the first week in June, in the year 2007. If the chemical had a 2-year shelf life, it should be viable until the first week of June 2009. Keep in mind that shelf life is based on optimum storage conditions: 65-75 F, away from heat/freezing, high humidity, etc. Exposure to these conditions will decrease the shelf life. Below are the shelf lives for chemicals in LaMotte kit # 5860.

<u>Chemical</u>	<u>Shelf Life</u>
Sodium Thiosulfate (# 4169)	1 year
Starch Indicator (# 4170)	1.5 years
Mang. Sulf. (# 4167)	3 years
Alk. Pot. Iodide Azide (# 7166)	3 years
Sulfuric Acid (# 6141)	3 years

The following table provides the estimated week number for the first week of each month.



<u>Week</u>	<u>Month</u>	<u>Week</u>	<u>Month</u>	<u>Week</u>	<u>Month</u>
1	Jan	17	April/May	35	Aug/Sept
5	Jan/Feb	21	May/June	40	Oct
8	Feb/Mar	26	July	44	Oct/Nov
13	April	30	July/Aug	48	Nov





## DISSOLVED OXYGEN TEST KIT

**CODE 5856**

For determining the dissolved oxygen content of water, this test kit uses the azide modification of the Winkler Method and employs a LaMotte Direct Reading Titrator in the final titration.

QUANTITY	CONTENTS	CODE
30	*Manganous Sulfate Solution	*4167-G
30	*Alkaline Potassium Iodide Azide	*7166-G
30	*Sulfuric Acid, 1:1	*6141WT-G
60	*Sodium Thiosulfate, 0.025N	*4169-H
30	Starch Indicator Solution	4170WT-G
1	Direct Reading Titrator, 0 - 10 Range	0377
1	Test Tube, 5-10-12.9-15-20-25 mL, glass, w/cap	0608
2	Bottles, Water Sampling, 60 mL, glass	0688-DO
1	Graduated Cylinder, 25 mL, plastic	2-2297

**\*WARNING:** Reagents marked with a \* are considered to be potential health hazards. To view or print a Material Safety Data Sheet (MSDS) for these reagents see MSDS CD or [www.lamotte.com](http://www.lamotte.com). To obtain a printed copy, contact LaMotte by e-mail, phone or fax..

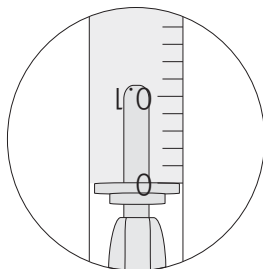
To order individual reagents or test kit components, use the specified code number.

**NOTE:** A Check Standard is needed to perform an "EPA Accepted" test.

WARNING! This set contains chemicals that may be harmful if misused. Read cautions on individual containers carefully. Not to be used by children except under adult supervision

## **DIRECT READING TITRATOR INSTRUCTIONS**

1. Fill the titration tube to the specified line with the water sample.
2. Add the reagents as specified in the instruction for the individual test method.
3. Cap the tube with the special titration tube cap. Mix by swirling gently.
4. Depress the plunger of the Titrator.
5. Insert the adapter tip into the special plastic plug in the titrating solution bottle.
6. Invert the bottle. Hold the bottle and the Titrator firmly together. Slowly pull out the plunger until the large ring on the plunger is opposite the zero (0) line on the scale.
7. If an air bubble appears in the Titrator barrel or the adapter tip, partially fill the barrel and pump the titration solution back into the inverted reagent bottle to expel the bubble.



**NOTE:** When filling the Titrator from a container without a special plug, submerge the adapter tip below the surface of the solution and pull out the plunger. Remove air bubbles.

8. Turn the bottle right side up and remove the Titrator.
9. Insert the adapter tip into the opening in the titrator tube cap. Slowly depress the plunger to dispense the titrating solution. Gently swirl the tube to mix the solution.
10. Continue adding the titrating solution until the specified color change occurs. If the color change does not occur when the large ring on the plunger reaches the bottom of the scale, refill the Titrator to the zero line. Continue the titration until the color change occurs.
11. Read the test result directly from the scale where the large ring on the Titrator meets the Titrator barrel. If the Titrator was refilled to reach the final color change, add the total amounts of titrant used to determine the final test result.
12. If no additional tests are to be made, discard the remaining titrating solution in the Titrator. Do not return the titrating solution to the reagent bottle. Thoroughly rinse the titration tube and the Titrator. Do not remove the plunger or the adapter tip from the Titrator.

## **DISSOLVED OXYGEN TEST PROCEDURE**

### **COLLECTION & TREATMENT OF THE WATER SAMPLE**

---

Steps 1 through 4 below describe proper sampling technique in shallow water. For sample collection at depths beyond arm's reach, special water sampling apparatus is required (e.g., the LaMotte Water Sampling Chamber, Code 1060; Model JT-1 Water Samplers, Code 1077; Water Sampling Outfit, Code 3103; or Code 3-0026 Water Sampling Bottle).

1. To avoid contamination, thoroughly rinse the Water Sampling Bottle (0688-DO) with sample water three times.
2. Tightly cap the bottle and submerge to the desired depth. Remove cap and allow the bottle to fill.
3. Tap the sides of the submerged bottle to dislodge any air bubbles clinging to the inside. Replace cap while the bottle is still submerged.
4. Retrieve bottle and examine it carefully to make sure that no air bubbles are trapped inside. Once a satisfactory sample has been collected, proceed immediately with Steps 5 & 6 to "fix" the sample.

**NOTE:** Be careful not to introduce air into the sample while adding the reagents in Steps 5 & 6. Simply drop the reagents into sample. Cap carefully, and mix gently.

5. Add 8 drops of \*Manganous Sulfate Solution (4167) and 8 drops of \*Alkaline Potassium Iodide Azide (7166). Cap and mix by inverting several times. A precipitate will form. Allow the precipitate to settle below the shoulder of the bottle before proceeding.
6. Add 8 drops of \*Sulfuric Acid, 1:1. Cap and gently shake until the reagent and the precipitate have dissolved. A clear-yellow to brown-orange color will develop, depending on the oxygen content of the sample.

**NOTE:** Following the completion of Step 6, contact between the water sample and the atmosphere will not affect the test result. Once the sample has been "fixed" in this manner, it is not necessary to perform the actual test procedure immediately. Thus, several samples can be collected and "fixed" in the field, and then carried back to a testing station or laboratory where the test procedure is to be performed.

## TITRATION

---

1. Fill the test tube (0608) to the 20 mL line with the “fixed” sample and cap.  
**NOTE:** For more precise oxygen measurements, fill graduated cylinder (2-2297) to 20 mL line with sample. Transfer to test tube (0608). Cap.
2. Fill the Direct Reading Titrator (0377) with \*Sodium Thiosulfate, 0.025N (4169).
3. Insert the Titrator into the center hole of the test tube cap. While gently shaking the tube, slowly press the plunger to titrate until the yellow-brown color is reduced to a very faint yellow.  
**NOTE:** If the color of the “fixed” sample is already a very faint yellow, skip to Step 4.
4. Remove the Titrator and cap. Be careful not to disturb the Titrator plunger, as the titration begun in Step 3 will be continued in Step 5. Add 8 drops of Starch Indicator Solution (4170WT). Sample should turn blue.
5. Replace the cap and Titrator. Continue titrating until the blue color just disappears. Read the test result directly from the scale where the large ring on the Titrator meets the Titrator barrel. Record as ppm dissolved oxygen.  
**NOTE:** Each minor division on the Titrator scale equals 0.2 ppm.
6. If the plunger tip reaches the bottom line on the Titrator scale (10 ppm) before the endpoint color change occurs, refill the Titrator and continue the titration. When recording the test result, be sure to include the value of the original amount of reagent dispensed (10 ppm).

## **LaMOTTE COMPANY**

**Helping People Solve Analytical Challenges<sup>SM</sup>**

PO Box 329 • Chestertown • Maryland • 21620 • USA  
800-344-3100 • 410-778-3100 (Outside U.S.A.) • Fax 410-778-6394  
Visit us on the web at [www.lamotte.com](http://www.lamotte.com)





**STANDARD OPERATING PROCEDURE**  
**MAINE VOLUNTEER RIVER MONITORING PROGRAM**  
**METHODS FOR USING THE YSI85**  
**HANDHELD METER IN RIVERS AND STREAMS**



**Note:** The mention of brand names does not constitute recommendation of a specific company.



## Volunteer River Monitoring Program (VRMP)

### Standard Operating Procedure Methods for using the YSI 85 Handheld Meter

**1. Applicability.** This standard operating procedure (SOP) is used by the Volunteer River Monitoring Program (VRMP) of the Maine Department of Environmental Protection's (DEP's) Bureau of Water Quality, Division of Environmental Assessment, Watershed Management Unit. It applies to the collection of dissolved oxygen (DO), temperature, specific conductance, and salinity from rivers and streams in Maine using the YSI 85 handheld meter.

**2. Purpose.** This purpose of this SOP is to provide standardized methods for volunteer groups to determine temperature, dissolved oxygen, specific conductance, and salinity of rivers and streams by volunteers as an instantaneous reading using the YSI 85 handheld meter.

### 3. Definitions.

**A. YSI.** Yellow Springs International, manufacturer of water quality monitoring meters.

**B. Specific Conductance.** A measure of the ability of a water solution to conduct an electrical current. Specific conductance is electrical conductivity (EC) that is being expressed in microsiemens per centimeter ( $\mu\text{s}/\text{cm}$ ) at a normalized temperature of 25 °C. Specific conductance is related to the type and concentration of ions in solution and can be used for approximating the dissolved-solids content of the water. Commonly, the concentration of dissolved solids (in mg/L) is about 65% of the specific conductance (in microsiemens). (*Note:* This relation is not constant from stream to stream, and it may vary in the same stream with changes in the composition of the water.)

**C. Probe.** Sensing device located at the end of a cable that is attached to the meter.

**D. KCl solution.** Potassium Chloride solution used to fill the probe.

**E. Calibration.** Set of procedures established by the manufacturer to ensure that the meter is operating properly; a critical quality assurance step in meter preparation prior to use.

**F. Membrane.** A clear, transparent and paper-thin substance similar to cellophane on the end of the probe. The membrane is permeable and allows gases such as oxygen to pass through into probe sensors while at the same time isolating most other undesirable substances.

**G. Jigging.** To move the probe under water using steady movements. Unless the probe is being held in swiftly flowing water, the probe shall be moved ("jigged") approximately 1 foot per second to overcome the inherent consumption of oxygen by the sensor.



## 4. Responsibilities.

### A. *Volunteer Monitors & Volunteer Groups*

- **Certification.** It is the responsibility of the individual obtaining this data to maintain current certification for the parameter(s) they collect if they wish their data to be entered into the VRMP database. Training will be provided to volunteers on an annual basis by VRMP/DEP staff, and certification will last for one year from the date of training.
- **Data Recording.** It is the responsibility of the individual obtaining this data to record the results and additional qualifying information on current field sheets obtained from their affiliated watershed association or through the VRMP program of the DEP.
- **Data Quality Checks and Data Submission.** The data manager for the volunteer group will collect and enter volunteer field sheet data onto the appropriate computer file, perform quality assurance checks (Refer to Section 5.10 of the Quality Assurance Program Plan), and submit data to the VRMP following protocols outlined in the volunteer group's latest sampling and analysis plan (SAP) that has been approved by the VRMP.

### B. *Volunteer River Monitoring Program (VRMP) Staff*

- **Oversight of Volunteer Groups and Volunteers.** VRMP staff will oversee volunteer groups and volunteers through a variety of ways including maintaining an up-to-date VRMP quality assurance program plan (QAPP); reviewing sampling and analysis plans (SAPs) of the volunteer groups; providing annual training/certification sessions for volunteers; conducting quality assurance checks on data submitted by volunteer groups and laboratories; and uploading data into the DEP's EGAD (Environmental and Geographic Analysis Database) database. These tasks are described in greater detail in the VRMP's latest QAPP.

## 5. Guidelines and procedures.

### A. *YSI 85 Meter Preparation.*

- **First time use.** Follow manufacturer's instructions for preparing meter for first time use. (Refer to Appendix A; Section 2 [Preparing the Meter] and Section 3 [Preparing the Probe]).
- **Beginning of field season.** Before each field season, volunteer monitoring groups shall conduct a full inspection of the meter. If membrane has been stored dry, follow manufacturer's instructions for first time use (see above). A new membrane cap and batteries shall be installed prior to the start of field sampling and additionally, as



needed (refer to Appendix A; Section 3 [Preparing the Probe]). VRMP staff will check meter against “benchmark” DO meter accuracy. In addition, each meter “setup” should be equipped with the following items so that field repairs can be undertaken as necessary:

- Extra KCL fluid and membrane caps for probe
  - Extra batteries
  - Field data sheet
  - Screwdriver for removing back of meter to replace batteries
  - Distilled Water (to clean the conductivity cell)
  - Pencil with eraser
- **Prior to field sampling.** Before each field sample collection, the volunteer should inspect the meter including an inspection of the condition of the probe membrane, membrane cap, and batteries.
    - (1) Check the membrane cap for air bubbles and wrinkles. If bubbles or wrinkles are present, remove membrane, refill with KCL solution, and replace membrane cap.
    - (2) Check to make sure drops of water are not clinging to the membrane. If drops are present, blow on membrane to gently remove droplets. Don't tap; these probes are very fragile. Replace probe into the calibration chamber on the side of the meter.
    - (3) Batteries should be checked for charge and/or expiration.
    - (4) Be familiar with the testing, inspection, maintenance, and calibration considerations described in sections 5.6 through 5.8 of the VRMP QAPP (DEP, 2009).
    - (5) Power on the meter and allow sufficient warm-up time (20 min) prior to initial use for the day.
  - **Specific Conductance Calibration.** If collecting specific conductance readings, users should conduct a system calibration check according to manufacturer's instructions and make adjustments at the annual VRMP volunteer and equipment certification workshop, with the assistance of VRMP staff. (Refer to Appendix A; Section 5 [Calibration].)
  - **Dissolved Oxygen Calibration.** If collecting dissolved oxygen measurements, the YSI 85 meter shall be calibrated each time the unit is turned on. Meters shall be calibrated to a 100% water-saturated air environment (for instructions, refer to Appendix A, Section 5 [Calibration]).
  - **Dissolved Oxygen Check Against “Zero Dissolved Oxygen” Standard.** VRMP staff shall check DO meters using zero oxygen standard at the beginning of the field season. Volunteers shall check their DO meter using zero oxygen solution in mid-season and end of the field season. The zero oxygen solution is provided by VRMP/DEP staff. Volunteers shall record the dissolved oxygen value they measure with their meter in the appropriate blank on the field data sheet. (See section 5-B of this SOP for instructions on how to make measurements with the YSI 85 meter.)



**B. Dissolved Oxygen/Temperature/Specific Conductance/Salinity Measurements.**

- **Sampling Period and Site Location.** Sampling period and site location information will be documented in the volunteer groups' SAPs (that require approval by the VRMP) which are submitted by the volunteer groups prior to any sampling. (Detailed information regarding how volunteer groups are to obtain and document site location information can be found in VRMP SOP-02 [Methods for Selecting and Documenting Site Locations].)
- **Sample Timing.** Dissolved oxygen data collected between dawn and 8 am are important for assessment of attainment of DO criteria within Maine's Water Quality Standards. But, except as naturally occurs, DO concentrations below the applicable DO criteria at any time of day signal non-attainment. If there are no DO concentrations below the criteria after 8 am, then data between dawn and 8 am must be collected to assess attainment of the criteria.
- **Familiarize Yourself with the Meter.** Familiarize yourself with the basic operation, keypad, and readouts of the meter (Appendix A; Section 1 [Introduction] and Section 4 [Overview of Operation]).
- **General Sampling Protocol.**
  - Record site location on data sheet.
  - Remove probe from calibration chamber.
  - Submerge probe in the water at the site where you are monitoring, as described in your group's approved SAP.
  - For any parameter (DO, specific conductance, temperature, salinity), allow the reading to stabilize (at least 15 seconds) before recording the value on the field sheet.
  - Follow the instructions below measuring specific parameters.
  - The meter should remain turned on between stations, unless time between samplings exceeds 30-60 minutes. If meter is turned off, the field probe should be stored inside the calibration chamber during transport, sufficient time (20 min) should be allowed for warm-up, and the meter should be re-calibrated.
- **Dissolved Oxygen Measurements.**
  - (1) Review and follow the instructions for making DO measurements in Section 7 [Making Measurements] (Appendix A). Make sure units are taken in mg/L (or ppm).
  - (2) *Note of caution:* Unless the probe is equipped with a stirrer, jiggling of the probe is extremely important for obtaining accurate dissolved oxygen readings, unless you have placed the probe in a swiftly-moving section of stream or river. (The probe is dependent on the amount of oxygen that passes across the membrane, and the probe actually consumes oxygen as it is making measurements.) An up-and-down motion (jiggling) creating movement of 1 foot per second is recommended.



- **Specific Conductance Measurements.**
  - (1) Make sure the meter is recording in terms of “specific conductance” as opposed to simply “conductivity”. The units for both specific conductance and conductivity are  $\mu\text{S}/\text{cm}$ , however for specific conductance, the display will show the  $^{\circ}\text{C}$  flashing on and off. (The  $^{\circ}\text{C}$  does NOT flash for conductivity mode.).
  - (2) Review and follow the instructions for making specific conductance measurements in Section 7 [Making Measurements] (Appendix A).
  - (3) Rinse the conductivity cell with distilled water after each use.
  
- **Temperature Measurements.**
  - (1) Review and follow the instructions for making temperature measurements in Section 7 [Making Measurements] (Appendix A).
  
- **Salinity Measurements.**
  - (1) Review and follow the instructions for making salinity measurements in Section 7 [Making Measurements] (Appendix A).
  
- **Quality Control.**
  - (1) At the beginning of each field season, all VRMP staff and VRMP volunteers who collect dissolved oxygen, temperature, specific conductance, and salinity data will have a training/refresher/certification session to (re)familiarize themselves with the contents of this SOP.
  - (2) For every volunteer, a field duplicate shall be obtained for all parameters for at least 10% of their own sampling efforts. A field duplicate will be collected for every 10 samples monitored.
  - (3) Refer to the VRMP quality assurance project plan (QAPP) for more QA/QC details.

## 6. Equipment Care.

### A. *Start of field season.*

1. Follow manufacturer's directions for preparation of a new probe or renewing probe in the spring (refer to (Appendix A; Section 2 [Preparing the Meter]). Be sure to replace membrane cap and membrane at the start of each sampling season.
2. Use new batteries at start of each sampling season. An extra set of appropriate size batteries should be included in the meter carrying case.
3. If needed, clean the probe (anode and cathode) according to manual directions.
4. Each D.O. meter should have the following items for making repairs in the field. See section 5-A of this SOP for a list of items.

### B. *Field Season*



1. Ideally the meter should be in water-resistant case with padding to protect it from damage.
2. Allow the case and contents to air-dry at end of each day. This may be accomplished by simply propping the lid open. When contents are very wet, remove the contents and spread out to facilitate drying.
3. Keep meter from freezing.
4. Refer to Appendix A (Sections 9 [Maintenance] and 13 [Warranty and Repair]) for manufacturer's recommendations for maintenance requirements.

**C. End of field season**

1. Completely dry meter, case, and all items in the case before storing.
2. Remove batteries.
3. Remove membrane cap, rinse and dry.
4. Rinse entire probe and calibration chamber with distilled water.
5. Follow manufacturer's instructions for cleaning the conductivity cell (Refer to Appendix A; Section 9 [Maintenance]).
6. Put membrane cap back on to keep dust and dirt out for winter.
7. Keep meter dry and at room temperature to prevent corrosion of electronic parts.
8. Review Appendix A (Section 13; [Warranty and Repair {plus cleaning and packing}]) for more tips.
9. Record winterization date and equipment repairs in your volunteer group's Equipment Log.
10. Label the meter and case as 'WINTERIZED' in an obvious manner (so users will know the current status of the unit).

**7. Specifications**

Measurement	Range	Resolution	Accuracy
Conductivity	0 – 4999 $\mu$ S/cm	1.0 $\mu$ S/cm	$\pm$ 0.5%
Salinity	0 to 80 ppt	0.1 ppt	$\pm$ 2 or 0.1 ppt
Temperature	-5 $^{\circ}$ C to 65 $^{\circ}$ C	0.1 $^{\circ}$ C	0.1 $^{\circ}$ C ( $\pm$ 1 sd)
Dissolved Oxygen	0 to 200 % Air Saturation	0.1% Air Saturation	$\pm$ 2% Air Saturation
	0 to 20 mg/L	0.01 mg/L	$\pm$ 0.3 mg/L

**8. Appendix**

**A. YSI Meter owner's manual:**

YSI Incorporated. 1998. YSI Model 85 Handheld Oxygen, Conductivity, Salinity, and Temperature System Operations Manual. Yellow Springs, Ohio.

**9. References**

**A. DEP Standard Operating Procedures:**



- Document number #:DEP-LW0890: Dissolved Oxygen and Temperature, Instantaneous Measurement using Electronic Meters
- Document number #: DEPLW0636: Protocols for using Hanna Dissolved Oxygen and Specific Conductance/Temperature/pH Meters

***B. Maine VRMP QAPP:***

- Maine Department of Environmental Protection (MDEP). 2020. Maine Volunteer River Monitoring Program (VRMP) Quality Assurance Program Plan (VRMP). Portland, ME. Document number #:DEPLW-0984.



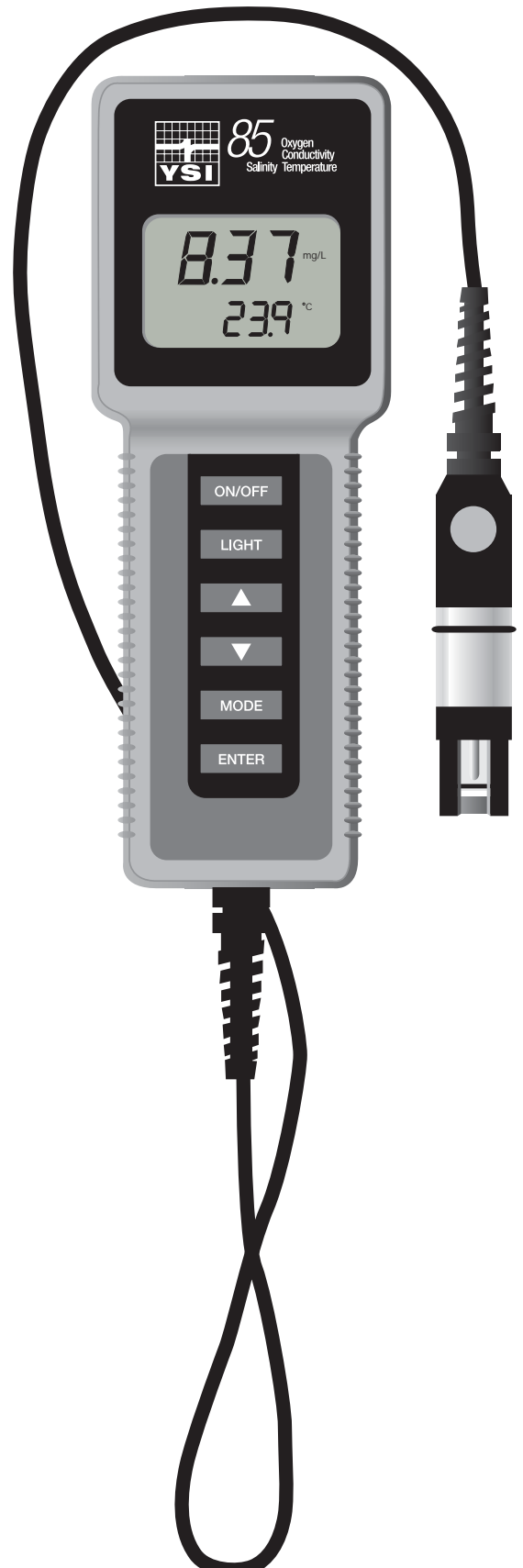
*YSI incorporated*



## YSI Model 85

Handheld Oxygen,  
Conductivity, Salinity,  
and Temperature  
System

**Operations  
Manual**





# CONTENTS

---

<b>SECTION 1 Introduction.....</b>	<b>1</b>
<b>SECTION 2 Preparing The Meter.....</b>	<b>3</b>
2.1 Unpacking.....	3
2.2 Warranty Card.....	3
2.3 Batteries .....	3
2.4 Calibration/Storage Chamber.....	5
2.5 Hand Strap .....	5
2.6 The Meter Case.....	5
<b>SECTION 3 Preparing The Probe.....</b>	<b>7</b>
3.1 Membrane Cap Installation.....	7
<b>SECTION 4 Overview Of Operation.....</b>	<b>9</b>
<b>SECTION 5 Calibration.....</b>	<b>11</b>
5.1 Calibration of Dissolved Oxygen.....	11
5.2 Calibration of Conductivity.....	12
<b>SECTION 6 Advanced Conductivity Setup.....</b>	<b>15</b>
6.1 Changing the Temperature Coefficient.....	15
6.2 Changing the Reference Temperature .....	16
6.3 Changing from Autoranging to Manual Ranging .....	16
<b>SECTION 7 Making Measurements .....</b>	<b>17</b>
7.1 Turning the Instrument On.....	17
7.2 The Measurement Modes of the Model 85.....	17
7.3 Autoranging and Range Searching .....	18
7.4 The Backlight.....	18
<b>SECTION 8 Saving Data.....</b>	<b>21</b>
8.1 Saving Data to Memory .....	21
8.2 Recalling Stored Data.....	21
8.3 Erasing Stored Data .....	22
<b>SECTION 9 Maintenance .....</b>	<b>23</b>
9.1 Cleaning and Storage.....	23
<b>SECTION 10 Principles Of Operation.....</b>	<b>25</b>
10.1 Temperature Effect on Conductivity .....	25

<b>SECTION 11 Discussion Of Measurement Errors.....</b>	<b>27</b>
11.1 Dissolved Oxygen Measurement Errors.....	27
11.2 Conductivity Measurement Errors.....	29
11.3 Dissolved Oxygen Probe Precautions.....	31
<b>SECTION 12 Troubleshooting .....</b>	<b>33</b>
<b>SECTION 13 Warranty And Repair .....</b>	<b>35</b>
<b>SECTION 14 Accessories And Replacement Parts .....</b>	<b>40</b>
<b>APPENDIX A Specifications .....</b>	<b>45</b>
<b>APPENDIX B Required Notice .....</b>	<b>47</b>
<b>APPENDIX C Temperature Correction Data .....</b>	<b>51</b>
<b>APPENDIX D Conversion Chart.....</b>	<b>53</b>
<b>APPENDIX E Oxygen Solubility Table .....</b>	<b>52</b>
<b>APPENDIX F Calibration Values Table.....</b>	<b>54</b>

# SECTION 1 INTRODUCTION

---

The YSI Model 85 Handheld Dissolved Oxygen, Conductivity, Salinity and Temperature System is a rugged, micro-processor based, digital meter with an attached YSI combination conductivity and dissolved oxygen probe.

The YSI Model 85 is designed for use in field, lab, and process control applications as well as for environmental, aquaculture, and industrial uses. The Model 85 is available with cable lengths of either 10, 25, 50 or 100 feet. The body of the probe has been manufactured with stainless steel to add rugged durability and sinking weight. The probe also utilizes our easy to install cap membranes for measuring dissolved oxygen.

The YSI Model 85 probe is a non-detachable, combination sensor designed specifically for the YSI Model 85 Handheld System. The conductivity portion is a four-electrode cell with a cell constant of 5.0/cm  $\pm$ 4%. The dissolved oxygen portion is a polarographic Clark type sensor.

The Model 85's microprocessor allows the system to be easily calibrated for dissolved oxygen or conductivity with the press of a few buttons. Additionally, the microprocessor performs a self-diagnostic routine each time the instrument is turned on. The self-diagnostic routine provides you with useful information about the conductivity cell constant and function of the instrument circuitry. The system simultaneously displays temperature (in °C), along with one of the following parameters: dissolved oxygen in either mg/L (milligrams per liter) or % air saturation; conductivity; temperature compensated conductivity; (in  $\mu$ S/cm or mS/cm), and salinity (in parts per thousand {ppt}).

The system requires only a single calibration regardless of which dissolved oxygen display you use. The calibration of conductivity is not required but is available. A single calibration will adjust the instrument, regardless if you are reading conductivity or temperature compensated conductivity. You can switch between all of these parameters with the push of a single key.

A calibration\storage chamber is built into the instrument case. A small sponge in the chamber can be moistened to provide a water saturated air environment that is ideal for air calibration of the dissolved oxygen probe. This chamber also provides a convenient place to store the probe when the system is not in use, and provides protection for the electrodes within the conductivity probe. The Model 85 case is also waterproof (rated to IP65). You can operate your Model 85 in the rain without damage to the instrument.

Six AA-size alkaline batteries power the instrument. A new set of alkaline batteries will provide approximately 100 hours of continuous operation. When batteries need to be replaced, the LCD will display a **“LO BAT”** message.



## SECTION 2 PREPARING THE METER

---

### 2.1 UNPACKING

---

When you unpack your new YSI Model 85 Handheld Dissolved Oxygen, Conductivity, Salinity and Temperature System for the first time, check the packing list to make sure you have received everything you should have. If there is anything missing or damaged, call the dealer from whom you purchased the Model 85. If you do not know which of our authorized dealers sold the system to you, call YSI Customer Service at 800-765-4974 or 937-767-7241, and we'll be happy to help you.

### 2.2 WARRANTY CARD

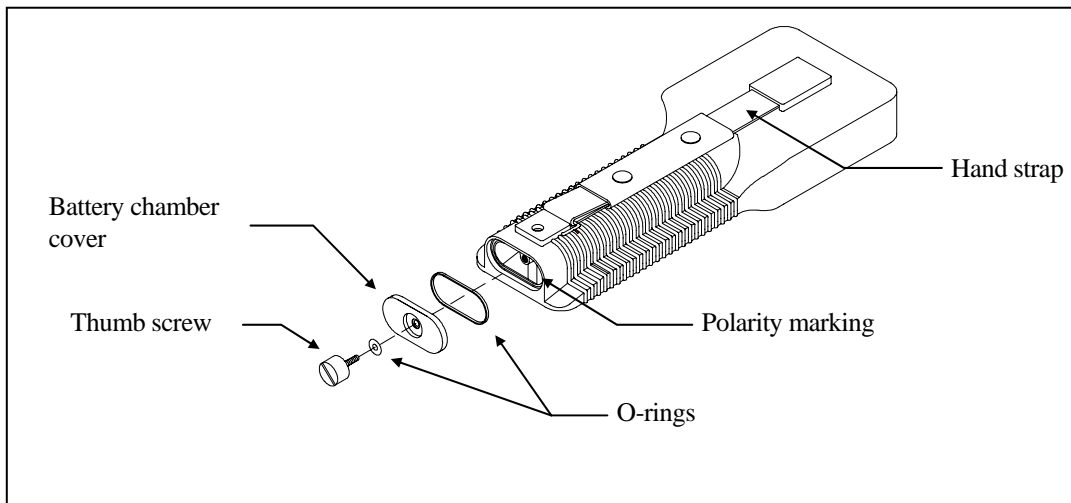
---

Before you do anything else, please complete the Warranty Card and return it to YSI. This will record your purchase of this quality instrument in our computer system. Once your purchase is recorded, you will receive prompt, efficient service in the event any part of your YSI Model 85 should ever need repair and we will be able to quickly verify the warranty period.

### 2.3 BATTERIES

---

There are a few things you must do to prepare your YSI Model 85 for use. First, locate the six AA-size alkaline batteries that were included in your purchase. Use a screwdriver or a small coin to remove the thumbscrew on the bottom of the instrument. This thumbscrew holds the battery-chamber cover in place. The battery-chamber cover is marked with the words "OPEN" and "CLOSE."



**NOTE:** On some models, the battery cover thumbscrew may be unscrewed by hand (a screwdriver may not be required).

There is a small label inside each of the two battery-chamber sleeves. These labels illustrate the correct way to install the batteries into each sleeve of the battery-chamber.

<p><b>NOTE:</b> It is very important that the batteries be installed <b>ONLY</b> as illustrated. The instrument will not function and may be damaged if the batteries are installed incorrectly.</p>
--



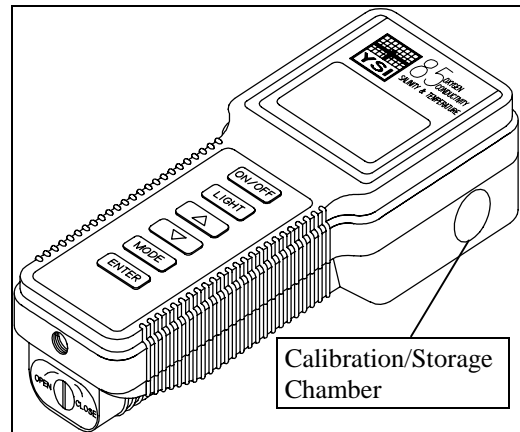
Turn the instrument on by pressing and releasing the **ON/OFF** button on the front of the instrument. The liquid crystal display (LCD) should come on. Allow a few seconds for the instrument to complete its diagnostic routine. Notice that the instrument will display the specific cell constant of the conductivity probe during this diagnostic routine. If the instrument does not operate, consult the section entitled Troubleshooting.

You may also want to take the instrument into a dark room and with the instrument ON, hold down the **LIGHT** button. The instrument backlight should illuminate the LCD so that the display can be easily read.

## 2.4 CALIBRATION/STORAGE CHAMBER

---

The Model 85 has a convenient calibration storage chamber built into the instruments' side. This chamber provides an ideal storage area for the probe during transport and extended non-use. If you look into the chamber you should notice a small round sponge in the bottom of the chamber. Carefully put 3 to 6 drops of clean water into the sponge. Turn the instrument over and allow any excess water to drain out of the chamber. The wet sponge creates a 100% water saturated air environment for the probe, which is ideal for dissolved oxygen calibration.



## 2.5 HAND STRAP

---

The hand strap is designed to allow comfortable operation of the Model 85 with minimum effort. If the hand strap is adjusted correctly, it is unlikely that the instrument will be easily dropped or bumped from your hand. See figure on previous page.

To adjust the hand strap on the back of the meter, unsnap the vinyl cover and pull the two Velcro strips apart. Place your hand between the meter and the strap and adjust the strap length so that your hand is snugly held in place. Press the two Velcro strips back together and snap the vinyl cover back into place.

## 2.6 THE METER CASE

---

The meter case is sealed at the factory and is not intended to be opened, except by authorized service technicians. Do not attempt to separate the two halves of the meter case as this may damage the instrument, break the waterproof seal, and will void the manufacturer's warranty.



## SECTION 3 PREPARING THE PROBE

---

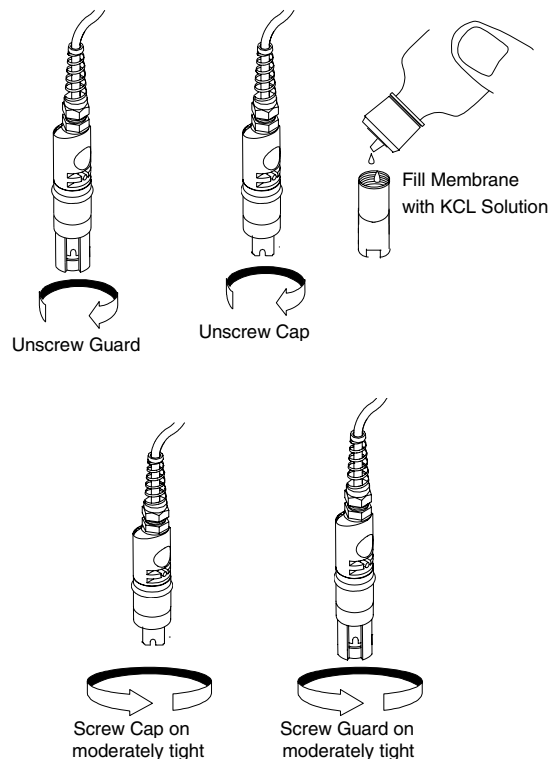
The YSI Model 85 dissolved oxygen probe is shipped dry. The protective membrane cap on the probe tip must be removed and replaced with KCl solution and a new membrane cap before using the probe. Follow the instructions below to install KCl solution and the new membrane cap.

### 3.1 MEMBRANE CAP INSTALLATION

---

To install a new membrane on your YSI Model 85 dissolved oxygen probe:

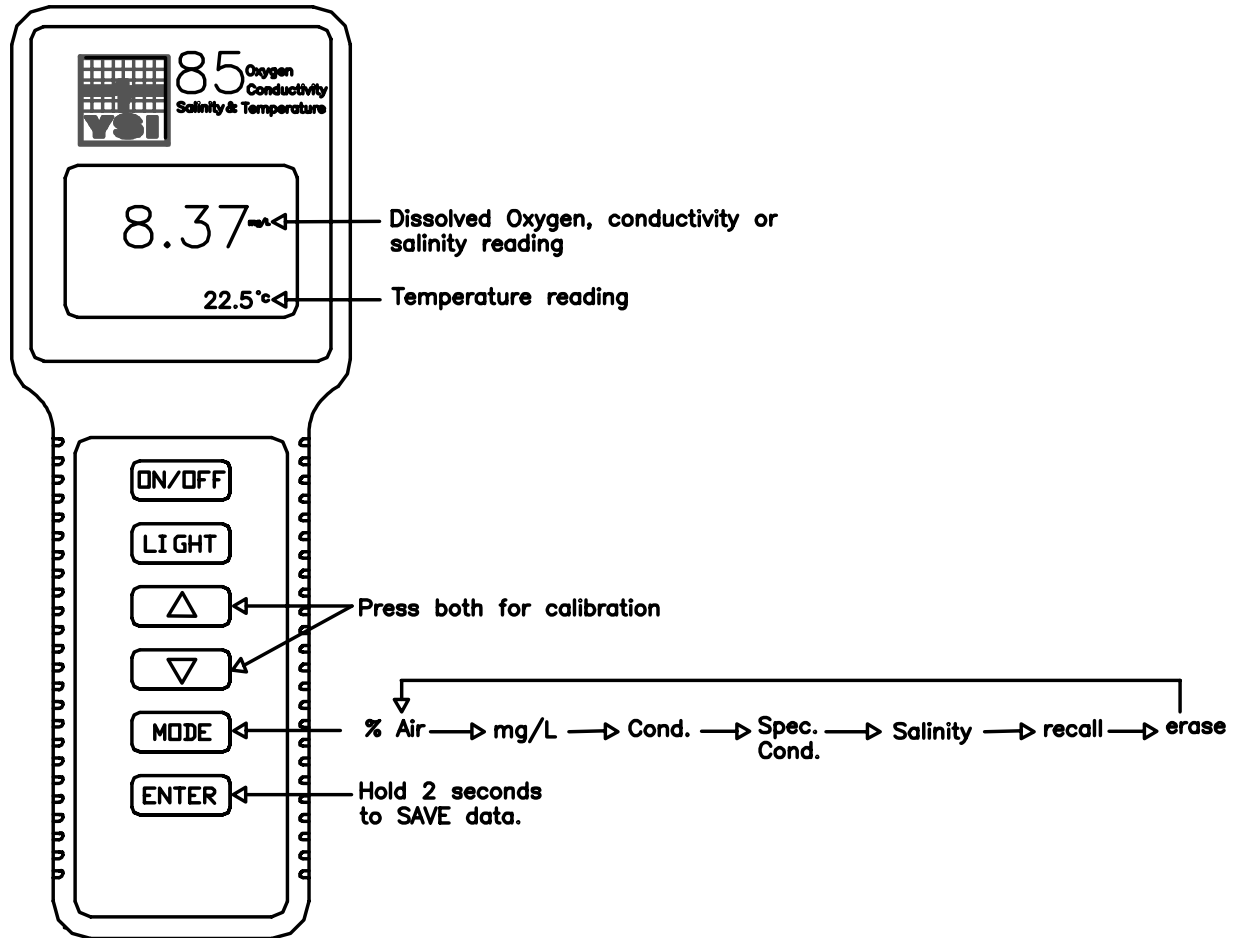
1. Unscrew and remove the probe sensor guard.
2. Unscrew and remove the old membrane cap.
3. Thoroughly rinse the sensor tip with distilled water.
4. Prepare the electrolyte according to the directions on the KCl solution bottle.
5. Hold the membrane cap and fill it at least 1/2 full with the electrolyte solution.
6. Screw the membrane cap onto the probe moderately tight. A small amount of electrolyte should overflow.
7. Screw the probe sensor guard on moderately tight.





# SECTION 4 OVERVIEW OF OPERATION

The following diagram is an overview of the operation of the Model 85. See the following sections for details of operation.





## SECTION 5 CALIBRATION

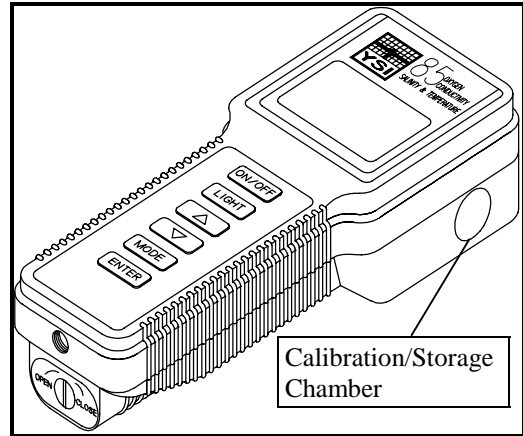
---

### 5.1 CALIBRATION OF DISSOLVED OXYGEN

---

To accurately calibrate the YSI Model 85 you will need to know the approximate altitude of the region in which you are located.

1. Ensure that the sponge inside the instrument's calibration chamber is wet. Insert the probe into the calibration chamber.
2. Turn the instrument on by pressing the **ON/OFF** button on the front of the instrument. Press the **MODE** button until dissolved oxygen is displayed in mg/L or %. Wait for the dissolved oxygen and temperature readings to stabilize (usually 15 minutes is required).



3. Use two fingers to press and release both the **UP ARROW** and **DOWN ARROW** buttons at the same time.
4. The LCD will prompt you to enter the local altitude in hundreds of feet. Use the arrow keys to increase or decrease the altitude. When the proper altitude appears on the LCD, press the **ENTER** button once.

**EXAMPLE:** Entering the number 12 here indicates 1200 feet.

5. The Model 85 should now display **CAL** in the lower left of the display, the calibration value should be displayed in the lower right of the display and the current % reading (before calibration) should be on the main display. Make sure that the current % reading (large display) is stable, then press the **ENTER** button. The display should read **SAVE** then should return to the Normal Operation Mode.

**Each time the Model 85 is turned off, it may be necessary to re-calibrate before taking measurements. All calibrations should be completed at a temperature which is as close as possible to the sample temperature. Dissolved oxygen readings are only as good as the calibration.**

## 5.2 CALIBRATION OF CONDUCTIVITY

---

**IMPORTANT:** System calibration is rarely required because of the factory calibration of the YSI Model 85. However, from time to time it is wise to check the system calibration and make adjustments when necessary.

**Prior to calibration of the YSI Model 85, it is important to remember the following:**

1. Always use clean, properly stored, NIST traceable calibration solutions (see Accessories and Replacement Parts). When filling a calibration container prior to performing the calibration procedures, make certain that the level of calibrant buffers is high enough in the container to cover the entire probe. Gently agitate the probe to remove any bubbles in the conductivity cell.
2. Rinse the probe with distilled water (and wipe dry) between changes of calibration solutions.
3. During calibration, allow the probe time to stabilize with regard to temperature (approximately 60 seconds) before proceeding with the calibration process. The readings after calibration are only as good as the calibration itself.
4. Perform sensor calibration at a temperature as close to 25°C as possible. This will minimize any temperature compensation error.

**Follow these steps to perform an accurate calibration of the YSI Model 85:**

1. Turn the instrument on and allow it to complete its self-test procedure.
2. Select a calibration solution that is most similar to the sample you will be measuring.
  - For sea water choose a 50 mS/cm conductivity standard (YSI Catalog# 3169)
  - For fresh water choose a 1 mS/cm conductivity standard (YSI Catalog# 3167)
  - For brackish water choose a 10 mS/cm conductivity standard (YSI Catalog # 3168)
3. Place at least 3 inches of solution in a clean glass beaker.
4. Use the **MODE** button to advance the instrument to display conductivity.
5. Insert the probe into the beaker deep enough so that the oval-shaped hole on the side of the probe is completely covered. Do not rest the probe on the bottom of the container -- suspend it above the bottom at least 1/4 inch.
6. Allow at least 60 seconds for the temperature reading to become stable.
7. Move the probe vigorously from side to side to dislodge any air bubbles from the electrodes.
8. Press and release the **UP ARROW** and **DOWN ARROW** buttons at the same time.

The **CAL** symbol will appear at the bottom left of the display to indicate that the instrument is now in Calibration mode.





9. Use the **UP ARROW** or **DOWN ARROW** button to adjust the reading on the display until it matches the value of the calibration solution you are using.
10. Once the display reads the exact value of the calibration solution being used (the instrument will make the appropriate compensation for temperature variation from 25°C), press the **ENTER** button once. The word "**SAVE**" will flash across the display for a second indicating that the calibration has been accepted.

The YSI Model 85 is designed to retain its last conductivity calibration permanently. Therefore, there is no need to calibrate the instrument after battery changes or power down.



## SECTION 6 ADVANCED CONDUCTIVITY SETUP

---

The default settings of the YSI Model 85 are appropriate for the vast majority of measurement applications. However, some measurement applications require very specific measurement criteria. For that reason, we have made the YSI Model 85 flexible to accommodate these “advanced users.”

If, for example, you are using the YSI Model 85 for a process control application that requires that the conductivity readings be compensated to 20 °C instead of 25 °C -- this is the section to read. Or, if your application for the YSI Model 85 involves the measurement of a very specific saline solution, the default temperature coefficient may need to be changed to get the very best measurement of that specific salt.

**IMPORTANT:** There is never a need to enter Advanced Setup Mode unless your special measurement application calls for a change in reference temperature and or temperature coefficient. Therefore, unless you are certain that your application requires a change to one or both of these criteria, do not modify the default reference temperature (25°C) or the default temperature coefficient (1.91%).

### 6.1 CHANGING THE TEMPERATURE COEFFICIENT

---

Follow these steps to modify the temperature coefficient of the Model 85.

1. Turn the instrument on and wait for it to complete its self-test procedure.
2. Use the **MODE** button to advance the instrument to display conductivity.
3. Press and release both the **DOWN ARROW** and the **MODE** buttons at the same time.

The **CAL** symbol will appear at the bottom left of the display. The large portion of the display will show **1.91 %** (or a value set previously using Advanced Setup).

4. Use the **UP ARROW** or **DOWN ARROW** button to change the value to the desired new temperature coefficient.
5. Press the **ENTER** button. The word “**SAVE**” will flash across the display for a second to indicate that your change has been accepted.
6. Press the **MODE** button to return to normal operation; the **CAL** symbol will disappear from the display.

## 6.2 CHANGING THE REFERENCE TEMPERATURE

---

Follow these steps to modify the reference temperature of the Model 85.

1. Turn the instrument on and wait for it to complete its self-test procedure.
2. Use the **MODE** button to advance the instrument to display conductivity.
3. Press and release both the **DOWN ARROW** and the **MODE** buttons at the same time.

The **CAL** symbol will appear at the bottom left of the display. The large portion of the display will show **1.91 %** (or a value set previously using Advanced Setup).

4. Press and release the **MODE** button; the large portion of the display will show **25.0C** (or a value set previously using Advanced Setup).
5. Use the **UP ARROW** or **DOWN ARROW** button to change the value to the desired new reference temperature (any value between 15 °C and 25 °C is acceptable).
6. Press the **ENTER** button. The word “**SAVE**” will flash across the display for a second to indicate that your change has been accepted.
7. The instrument will automatically return to normal operation mode.

## 6.3 CHANGING FROM AUTORANGING TO MANUAL RANGING

---

If your application is easier to perform using a manual range that you select, the YSI Model 85 allows you to turn off the default autoranging feature. While you are making conductivity or temperature compensated conductivity measurements, simply press and release the **UP ARROW** button. Each additional press of the **UP ARROW** button will cycle the Model 85 to a different manual range until you return again to autoranging. Five pushes of the **UP ARROW** button will cycle the Model 85 through the four manual ranges and return the instrument to autoranging.

**NOTE:** You may see an error message in some manual ranges if the manual range selected is not adequate for the sample you are measuring. If this happens, simply press and release the **UP ARROW** button again until a range is selected which is suitable for your sample. If you get lost and don't know if you're in a manual range or autoranging, simply turn the instrument off and back on. Also note that the conductivity units will flash while you are in manual range. The instrument will always default to autoranging when first turned on.

The four ranges of the YSI Model 85 are:

<b>Range 1</b>	<b>Range 2</b>	<b>Range 3</b>	<b>Range 4</b>
0 to 499.9 $\mu$ S/cm	0 to 4999 $\mu$ S/cm	0 to 49.99 mS/cm	0 to 200.0 mS/cm

## SECTION 7 MAKING MEASUREMENTS

---

### 7.1 TURNING THE INSTRUMENT ON

---

Once the batteries are installed correctly, press the **ON/OFF** button. The instrument will activate all segments of the display for a few seconds, which will be followed by a self-test procedure that will last for several more seconds. During this power on self-test sequence, the instrument's microprocessor is verifying that the instrument is working properly. The Model 85 will display the cell constant of the conductivity probe when the self-test is complete. If the instrument were to detect an internal problem, the display would show a **continuous** error message. See the section entitled Troubleshooting for a list of these error messages.

### 7.2 THE MEASUREMENT MODES OF THE MODEL 85

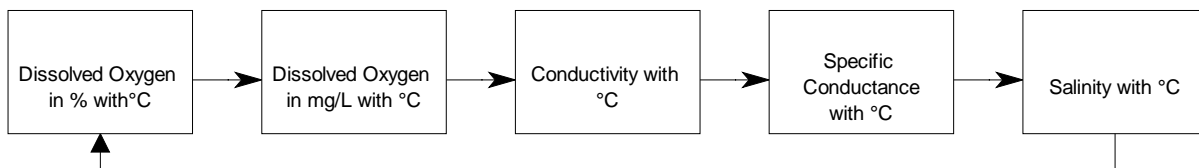
---

The Model 85 is designed to provide six distinct measurements:

- **Dissolved Oxygen %** -- A measurement of oxygen in percent of saturation.
- **Dissolved Oxygen mg/L** -- A measurement of oxygen in mg/L
- **Conductivity** -- A measurement of the conductive material in the liquid sample without regard to temperature
- **Specific Conductance** -- Also known as temperature compensated conductivity which automatically adjusts the reading to a calculated value which would have been read if the sample had been at 25° C (or some other reference temperature which you choose). See Advanced Setup.
- **Temperature** -- which is always displayed.
- **Salinity** -- A calculation done by the instrument electronics, based upon the conductivity and temperature readings.

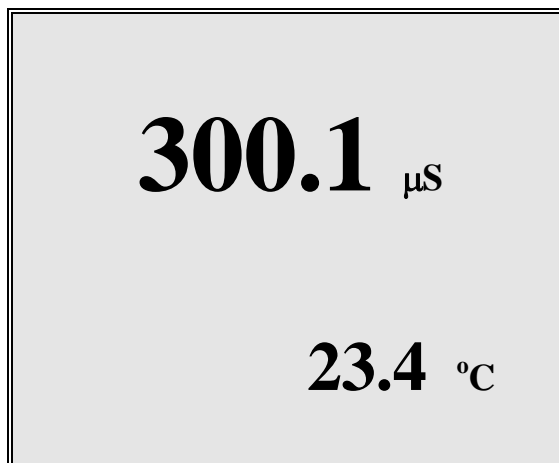
**NOTE:** When you turn the Model 85 off, it will “remember” which mode you used last and will return to that mode the next time the instrument is turned on.

To choose one of the measurement modes above (temperature is always displayed) simply press and release the **MODE** button. Carefully observe the small legends at the far right side of the LCD.



If the instrument is reading **Specific Conductance** the large numbers on the display will be followed by either a  $\mu\text{S}$  or an **mS**. Additionally the small portion of the display will show the  $^{\circ}\text{C}$  flashing on and off.

If the instrument is reading **Conductivity** (not temperature compensated) the large numbers on the display will be followed by either a  $\mu\text{S}$  or an **mS**. Additionally the small portion of the display will show the  $^{\circ}\text{C}$  **NOT** flashing.



If the instrument is reading **Dissolved Oxygen** the large numbers on the display will be followed by either a mg/L or %. It is important to remember that the dissolved oxygen probe is stirring dependent. This is due to the consumption of oxygen at the sensor tip during measurement. When taking dissolved oxygen measurements the probe must be moved through the sample at a rate of 1 foot per second to provide adequate stirring.

If the instrument is reading **Salinity** the large numbers on the display will be followed by a **ppt**.

### 7.3 AUTORANGING & RANGE SEARCHING

---

The YSI Model 85 is an autoranging instrument. This means that regardless of the conductivity or salinity of the solution (within the specifications of the instrument) all you need to do to get the most accurate reading is to put the probe in the sample. This feature makes the Model 85 as simple as possible to operate.

When you first place the Model 85 probe into a sample or calibration solution, and again when you first remove the probe the instrument will go into a range search mode that may take as long as 5 seconds. During some range searches the instrument display will flash **rANG** to indicate its movement from one range to another. The length of the range search depends on the number of ranges that must be searched in order to find the correct range for the sample. During the range search, the instrument will appear to freeze on a given reading for a few seconds then, once the range is located, will pinpoint the exact reading on the display. The display may also switch to **00.0** for a second or two during a range search before it selects the proper range.

### 7.4 THE BACKLIGHT

---

At times it may be necessary to take measurements with the Model 85 in dark or poorly lit areas. To help in this situation, the Model 85 comes equipped with a backlight that will illuminate the display so that it can be easily read. To activate the backlight, press and hold the **LIGHT** button. The display will remain lit as long as the button is depressed. When you release it, the light goes out to preserve battery life.







## SECTION 8 SAVING DATA

---

The Model 85 is equipped with non-volatile memory that is capable of storing up to 50 different sets of readings. Non-volatile means that you do not need to worry that your data will be lost due to a power failure or power interrupt. The Model 85 will also assign a site identity number to each set of readings to allow easy review of the data. This feature is useful in situations where transcribing data is difficult or not available.

### 8.1 SAVING DATA TO MEMORY

---

1. While any parameter is displayed on the screen depress the **ENTER** button and hold for approximately 2 seconds. The meter will flash **SAVE** on the display along with the current site identity being used.
2. When all 50 sites are full the display will flash **FULL** on the screen. This message will remain on the screen (even after power down) until a button is pushed.

Once you have acknowledged the memory is full, any subsequent saved data will begin overwriting existing data starting with site #1.

### 8.2 RECALLING STORED DATA

---

1. To put the Model 85 into the **RECALL** mode depress the **MODE** button repeatedly until **rcl** is displayed on the screen along with the site ID number in the lower right corner. (see figure #1)
2. Depress the **ENTER** button to review the last set of data that was saved. The Model 85 will display the dissolved oxygen in % saturation and temperature. Another press of the **ENTER** button will display the dissolved oxygen in mg/L and the temperature.

Depress the **ENTER** button again and again to review the conductivity, specific conductivity and salinity readings. All of which are displayed with the temperature.

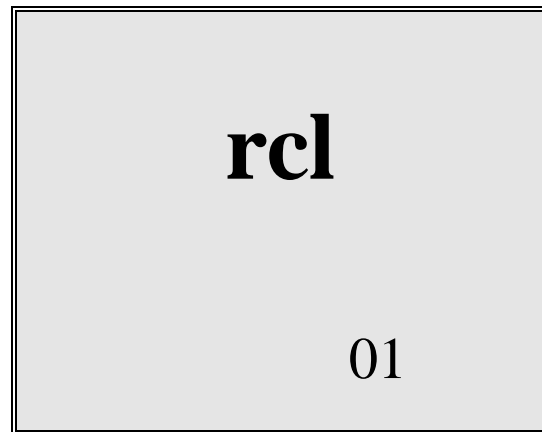


FIGURE #1

3. Depress the **UP ARROW** button to increment through the saved sets of data.
4. Depress the **DOWN ARROW** button to decrement through the saved sets of data.
5. When the correct site ID# is displayed, press the **ENTER** button to display the data.

6. When you have finished recalling data, press the **MODE** button to return to normal operation.

**NOTE:** The Model 85 will recall data as a list. When the **UP ARROW** is depressed the Model 85 will display the Site ID# for the previously recorded date. For example: If you are reviewing Site ID# 5 and the **UP ARROW** is depressed the Model 85 will display Site ID# 4. If you are reviewing Site ID# 5 and Site ID# 5 was the last set of data stored the **DOWN ARROW** button will display Site ID# 1.

Here is an example of the Model 85 memory.

Site ID #1

Site ID #2

Site ID #3 ← If the **UP ARROW** button was pressed the Model 85 would display Site ID #2

Site ID #4

Site ID #5

### 8.3 ERASING STORED DATA

---

1. To erase the data that is stored into the Model 85's memory, depress the **MODE** button repeatedly until the Model 85 displays **ErAS** on the screen. (see figure #2)

2. Depress and hold the **DOWN ARROW** and **ENTER** buttons simultaneously for approximately 5 seconds.

3. The Model 85 flashing **DONE** on the display for 1 to 2 seconds indicates successful erasure. The instrument will automatically change to normal operation after completion.

**IMPORTANT:** Data in all 50 site ID's will be erased completely and will be lost forever. Do not use the erase function until all recorded data has been transcribed to an archive outside the Model 85.

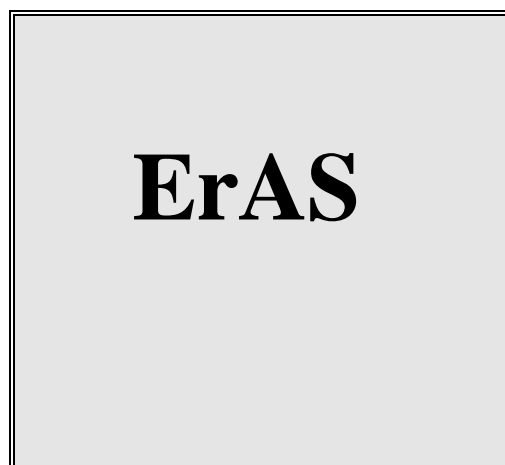


figure #2

## SECTION 9 MAINTENANCE

---

### 9.1 CLEANING AND STORAGE

---

The single most important requirement for accurate and reproducible results in conductivity measurement is a clean cell. A dirty cell will change the conductivity of a solution by contaminating it.

**NOTE:** ALWAYS RINSE THE CONDUCTIVITY CELL WITH CLEAN WATER AFTER EACH USE.

To clean the conductivity cell:

1. Dip the cell in cleaning solution and agitate for two to three minutes. Any one of the foaming acid tile cleaners, such as Dow Chemical Bathroom Cleaner, will clean the cell adequately. When a stronger cleaning preparation is required, use a solution of 1:1 isopropyl alcohol and 1 N HCl. Remove the cell from the cleaning solution.
2. Use the nylon brush (supplied) to dislodge any contaminants from inside the electrode chamber.
3. Repeat steps one and two until the cell is completely clean. Rinse the cell thoroughly in deionized, or clean tap water.
4. Store the conductivity cell in the meter storage chamber.

**NOTE:** See Section 11, Dissolved Oxygen Probe Precautions for instructions on cleaning the dissolved oxygen electrodes.



## SECTION 10 PRINCIPLES OF OPERATION

---

The dissolved oxygen sensor utilizes an oxygen permeable membrane that covers an electrolytic cell consisting of a gold cathode and a porous silver anode. This membrane acts as a diffusion barrier and an isolation barrier preventing fouling of the cathode surface by impurities in the environment. Upon entering the cell through the membrane, oxygen is reduced at an applied potential of -0.8 V referenced to the silver electrode. The reduction current at the cathode is directly proportional to the partial pressure of oxygen in liquid (expressed as %-air saturation) which is proportional to the concentration of dissolved oxygen (in mg/L) at a particular temperature. Thus the same partial pressure of oxygen (% air-saturation) in liquid gives different concentrations of dissolved oxygen (mg/L) at different temperatures because of the different solubility's of oxygen at different temperatures.

The conductivity cell utilizes four pure nickel electrodes for the measurement of solution conductance. Two of the electrodes are current driven, and two are used to measure the voltage drop. The measured voltage drop is then converted into a conductance value in milli-Siemens (millimhos). To convert this value to a conductivity (specific conductance) value in milli-Siemens per cm (mS/cm), the conductance is multiplied by the cell constant that has units of reciprocal cm ( $\text{cm}^{-1}$ ). The cell constant for the Model 85 conductivity cell is  $5.0/\text{cm} \pm 4\%$ . For most applications, the cell constant is automatically determined (or confirmed) with each deployment of the system when the calibration procedure is followed. Solutions with conductivity's of 1.00, 10.0, 50.0, and 100.0 mS/cm, which have been prepared in accordance with recommendation 56-1981 of the Organisation Internationale de Métrologie Légale (OIML) are available from YSI. The instrument output is in  $\mu\text{S}/\text{cm}$  or mS/cm for both conductivity and specific conductance. The multiplication of cell constant times conductance is carried out automatically by the software.

### 10.1 TEMPERATURE EFFECT ON CONDUCTIVITY

---

The conductivity of solutions of ionic species is highly dependent on temperature, varying as much as 3% for each change of one degree Celsius (temperature coefficient = 3%/C). In addition, the temperature coefficient itself varies with the nature of the ionic species present.

Because the exact composition of a natural media is usually not known, it is best to report a conductivity at a particular temperature, e.g. 20.2 mS/cm at 14 C. However, in many cases, it is also useful to compensate for the temperature dependence in order to determine at a glance if gross changes are occurring in the ionic content of the medium over time. For this reason, the Model 85 software also allows the user to output conductivity data in either raw or temperature compensated form. If "Conductivity" is selected, values of conductivity that are NOT compensated for temperature are output to the display. If "Specific Conductance" is selected, the Model 85 uses the temperature and raw conductivity values associated with each determination to generate a specific conductance value compensated to a user selected reference temperature (see Advanced Setup) between 15 C and 25 C. Additionally the user can select any temperature coefficient from 0% to 4% (see Advanced Setup). Using the Model 85 default reference temperature and temperature coefficient (25 C and 1.91%), the calculation is carried out as in equation (1) below:

$$\text{Specific Conductance (25°C)} = \frac{\text{Conductivity}}{1 + \text{TC} * (\text{T} - 25)}$$

As noted above, unless the solution being measured consists of pure KCl in water, this temperature compensated value will be somewhat inaccurate, but the equation with a value of TC = 0.0191 will provide a close approximation for solutions of many common salts such as NaCl and NH<sub>4</sub>Cl and for seawater.

Salinity is determined automatically from the Model 85 conductivity readings according to algorithms found in Standard Methods for the Examination of Water and Wastewater (ed. 1989). The use of the Practical Salinity Scale 1978 results in values which are unitless, since the measurements are carried out in reference to the conductivity of standard seawater at 15 C. However, the unitless salinity values are very close to those determined by the previously-used method where the mass of dissolved salts in a given mass of water (parts per thousand) was reported. Hence, the designation "ppt" is reported by the instrument to provide a more conventional output. For further information on conductivity and the above standard information, refer to the ASTM document, Standard Methods of Test for Electrical Conductivity of Water and Industrial Wastewater, ASTM Designation D1125-82, and OIML Recommendation Number 56. ASTM symbols for conductivity, cell constant, and path length differ from those preferred in the general literature and also from those used in this manual.

# SECTION 11 DISCUSSION OF MEASUREMENT ERRORS

---

## 11.1 DISSOLVED OXYGEN MEASUREMENT ERRORS

---

There are three basic types of error. Type 1 errors are related to limitations of instrument design and tolerances of instrument components. These are chiefly the meter linearity and the resistor tolerances. Type 2 errors are due to basic probe accuracy tolerances, chiefly background signal, probe linearity, and variations in membrane temperature coefficient. Type 3 errors are related to the operator's ability to determine the conditions at the time of calibration. If calibration is performed against more accurately known conditions, type 3 errors are appropriately reduced.

**The sample calculations that follow are for a near extreme set of conditions.**

### TYPE 1 ERRORS

- A. Meter linearity error:  $\pm 1\%$  of full scale reading, or  $\pm 0.15$  mg/l
- B. Component and circuitry error:  $\pm 0.05$  mg/l

### TYPE 2 ERRORS

- A. Temperature compensation for membrane temperature coefficient:  $\pm 0.03$  mg/l
- B. Temperature measurement errors: A maximum  $\pm 0.2^\circ\text{C}$  probe error is equal to  $\pm 0.14$  mg/l

**TYPE 3 ERRORS**

## A. Altitude:

A 1000-foot change in altitude is equal to an error of approximately 3% at the 10 mg/l level.

## B. Humidity:

Errors occur if calibration is performed at less than 100% humidity. The error varies with the temperature as follows:

TEMPERATURE	ERROR
0°C	0.02 mg/l
10°C	0.05 mg/l
20°C	0.12 mg/l
30°C	0.27 mg/l
40°C	0.68 mg/l

**APPROXIMATING THE ERROR**

It is unlikely that the actual error in any measurement will be the maximum possible error. A better error approximation is obtained using a root mean squared (r.m.s.) calculation:

$$\text{r.m.s. error} = \pm[1a^2 + 1b^2 + 2a^2 + 2b^2 + 3a^2 + 3b^2]^{1/2} \text{ mg/l}$$



## 11.2 CONDUCTIVITY MEASUREMENT ERRORS

---

System accuracy for conductivity measurements is equal to the sum of the errors contributed by the environment and the various components of the measurement setup. These include:

- Instrument accuracy
- Cell-constant error
- Solution temperature offset
- Cell contamination (including air bubbles)
- Electrical noise
- Galvanic effects

Only the first three are of major concern for typical measurements, although the user should also be careful to see that cells are clean and maintained in good condition at all times.

**Instrument Accuracy** =  $\pm .5\%$  maximum

The accuracy specified for the range being used is the worst case instrument error.

**Cell-Constant Error** =  $\pm .5\%$  maximum

Although YSI cells are warranted to be accurate to within one percent, you should still determine the exact cell constant of your particular cell. Contamination or physical damage to the cell can alter the cell constant. Performing a calibration will eliminate any error that might arise because of cell constant change.

YSI cells are calibrated to within one percent of the stated cell constant at a single point. We consider these products to be usefully linear over most instrument ranges. The cell constant can be calibrated to  $\pm 0.35\%$  accuracy with YSI conductivity calibrator solutions.

**Temperature Error** =  $\pm 1\%$  maximum

The solution temperature error is the product of the temperature coefficient and the temperature offset from 25 °C, expressed as a percentage of the reading that would have been obtained at 25 °C. The error is not necessarily a linear function of temperature. The statement of error is derived from a 25 °C temperature offset and a 3%/°C temperature coefficient.

**Total Error**

Considering only the above three factors, system accuracy under worst case conditions will be  $\pm 2\%$ , although the actual error will be considerably less if recommended and properly calibrated cells and instrument ranges are used. Additional errors, which can essentially be eliminated with proper handling, are described below.

**Cell Contamination**

This error is usually due to contamination of the solution being measured, which occurs when solution is carried-over from the last solution measured. Thus, the instrument might be correctly reporting the conductivity seen, but the reading does not accurately represent the value of the bulk

solution. Errors will be most serious when low conductivity solutions are contaminated by carry-over from high conductivity solutions, and can then be of an order of magnitude or more.

Follow the cleaning instructions carefully before attempting low conductivity measurements with a cell of unknown history or one that has been previously used in higher value solutions.

An entirely different form of contamination sometimes occurs due to a buildup of foreign material directly on cell electrodes. While rare, such deposits have, on occasion, markedly reduced the effectiveness of the electrodes. The result is an erroneously low conductance reading.

### **Electrical-Noise Errors**

Electrical noise can be a problem in any measurement range, but will contribute the most error and be the most difficult to eliminate when operating in the lowest ranges. The noise may be either line-conducted or radiated or both, and may require, grounding, shielding, or both.

### **Galvanic and Miscellaneous Effects**

In addition to the error sources described above, there is another class of contributors that can be ignored for all but the most meticulous of laboratory measurements. These errors are always small and are generally completely masked by the error budget for cell-constant calibration, instrument accuracy, etc. Examples range from parasitic reactance associated with the solution container and its proximity to external objects to the minor galvanic effects resulting from oxide formation or deposition on electrodes. Only trial and error in the actual measurement environment can be suggested as an approach to reduce such errors. If the reading does not change as the setup is adjusted, errors due to such factors can be considered too small to see.

### 11.3 DISSOLVED OXYGEN PROBE PRECAUTIONS

---

1. Membrane life depends on usage. Membranes will last a long time if installed properly and treated with care. Erratic readings are a result of loose, wrinkled, damaged, or fouled membranes, or from large (more than 1/8" diameter) bubbles in the electrolyte reservoir. If erratic readings or evidence of membrane damage occurs, you should replace the membrane and the KCl solution. The average replacement interval is two to four weeks.
2. If the membrane is coated with oxygen consuming (e.g. bacteria) or oxygen evolving organisms (e.g. algae), erroneous readings may occur.
3. Chlorine, sulfur dioxide, nitric oxide, and nitrous oxide can affect readings by behaving like oxygen at the probe. If you suspect erroneous readings, it may be necessary to determine if these gases are the cause.
4. Avoid any environment that contains substances that may attack the probe materials. Some of these substances are concentrated acids, caustics, and strong solvents. The probe materials that come in contact with the sample include FEP Teflon, stainless steel, epoxy, polyetherimide and the polyurethane cable covering.
5. For correct probe operation, the gold cathode must always be bright. If it is tarnished (which can result from contact with certain gases) or plated with silver, the gold surface must be restored. To restore the cathode, you may either return the instrument to the factory or clean it using the YSI 5238 probe reconditioning kit. Never use chemicals or abrasives not supplied with this kit.

**NOTE: Model 85 probes built before July, 1996 (serial numbers starting with 96F or lower), should be cleaned with the sanding disc mounted on a FLAT surface. Do NOT use the curved tool provided in the 5238 probe reconditioning kit on these probes.**

6. It is also possible for the silver anode to become contaminated, which will prevent successful calibration. To clean the anode, remove the membrane and soak the probe overnight in 3% ammonium hydroxide. Next, rinse the sensor tip with deionized water, add new KCl solution, and install a new membrane. Turn the instrument on and allow the system to stabilize for at least 30 minutes. If, after several hours, you are still unable to calibrate, return the YSI Model 85 system to an authorized service center for service.
7. To keep the electrolyte from drying out, store the probe in the calibration chamber with the small piece of sponge.



## SECTION 12 TROUBLESHOOTING

SYMPTOM	POSSIBLE CAUSE	ACTION
1. Instrument will not turn on	A. Low battery voltage B. Batteries installed wrong C. Meter requires service	A. Replace batteries B. Check battery polarity. C. Return system for service
2. Instrument will not calibrate (Dissolved Oxygen)	A. Membrane is fouled or damaged B. Probe anode is fouled or dark C. Probe cathode is tarnished D. System requires service	A. Replace membrane & KCl B. Clean anode C. Clean cathode D. Return system for service
3. Instrument will not calibrate (Conductivity)	A. Cell is contaminated	A. See "Maintenance" Section
4. Instrument "locks up"	A. Instrument has rec'd a shock B. Batteries are low or damaged C. System requires service	A & B. Remove battery lid, wait 15 seconds for reset, replace lid. C. Return system for service
5. Instrument readings are inaccurate (Dissolved Oxygen)	A. Cal altitude is incorrect B. Probe not in 100% O <sub>2</sub> saturated air during Cal procedure C. Membrane fouled or damaged D. Probe anode is fouled or dark E. Probe cathode is tarnished F. System requires service	A. Recalibrate w/correct value B. Moisten sponge & place in Cal chamber w/ probe & Recal C. Replace membrane D. Clean anode E. Clean cathode F. Return system for service
6. Instrument readings are inaccurate (Conductivity)	A. Calibration is required B. Cell is contaminated C. Tempco is set incorrectly D. Reference temperature incorrect E. Readings are or are not temperature compensated.	A. See "Calibration" Section B. See "Maintenance" Section C. See "Advanced Setup" Section D. See "Advanced Setup" Section E. See "Making Measurements" Section
7. LCD displays "LO BAT" Main display flashes "off"	A. Batteries are low or damaged	A. Replace batteries
8. Main Display reads "OVER" (Secondary display reads "ovr") (Secondary display reads "udr")	A. Conductivity reading is >200 mS B. Temperature reading is >65°C C. Temperature reading is <-5°C D. Salinity reading is >80 ppt E. User cell constant cal K is >5.25 F. DO temperature is >46°C G. DO % saturation is >200% H. DO concentration is >20 mg/L	In all cases, check calibration values and procedures; check advanced setup settings.  If each of these are set correctly, return instrument for service.
9. Main display reads "Undr"	A. User cell constant cal K is <4.9 B. DO current too low to calibrate	A. Recalibrate instrument using known good conductivity standard. Follow cell cleaning procedure in the Maintenance section. B. Replace membrane, clean probe
10. Main display reads "rErr"	A. Reading exceeds user selected manual range.	A. Use the mode key to select a higher or lower manual range, or set system to autoranging.
11. Main display reads "PErr"	A. User cell constant cal K is 0.0 B. Incorrect sequence of keystrokes.	A. See "Advanced Setup" section. B. Refer to manual section for step by step instruction for the function you are attempting.

SYMPTOM	POSSIBLE CAUSE	ACTION
12. Main display reads "LErr"	A. In temperature compensated conductivity mode, temperature exceeds the values computed using user defined temperature coefficient and/or reference temperature. B. In cell constant cal mode, temperature exceeds the values computed using user defined temperature coefficient and/or reference temperature.	A. & B. Adjust user defined tempco or reference temperature. (pg. 10)
13. Main display reads "Err" (Secondary display reads "ra")	A. System has failed its RAM test check procedure.	A. Turn instrument OFF and back ON again. B. Return the system for service (pg. 26)
14. Main display reads "Err" (Secondary display reads "ro")	A. System has failed its ROM test check procedure.	A. Turn instrument OFF and back ON again. B. Return the system for service (pg. 26)
15. Secondary display reads "rEr"	A. Temperature jumper is set to °F and reading is >199.9°F but <203°F.	A. Return the system for service. (pg. 26)
16. Main display reads "FAIL" (Secondary display reads "eep")	A. EEPROM has failed to respond in time.	A. Return the system for service. (pg. 26)
17. Readings on main display don't change	A. Meter is in recall mode.	A. Press <b>MODE</b> button to return to Normal Operation (pg. 12)

## SECTION 13 WARRANTY AND REPAIR

---

YSI Model 85 Handheld Meters are warranted for two years from date of purchase by the end user against defects in materials and workmanship. YSI Model 85 probes and cables are warranted for one year from date of purchase by the end user against defects in material and workmanship. Within the warranty period, YSI will repair or replace, at its sole discretion, free of charge, any product that YSI determines to be covered by this warranty.

To exercise this warranty, write or call your local YSI representative, or contact YSI Customer Service in Yellow Springs, Ohio. Send the product and proof of purchase, transportation prepaid, to the Authorized Service Center selected by YSI. Repair or replacement will be made and the product returned, transportation prepaid. Repaired or replaced products are warranted for the balance of the original warranty period, or at least 90 days from date of repair or replacement.

### **Limitation of Warranty**

This Warranty does not apply to any YSI product damage or failure caused by (i) failure to install, operate or use the product in accordance with YSI's written instructions, (ii) abuse or misuse of the product, (iii) failure to maintain the product in accordance with YSI's written instructions or standard industry procedure, (iv) any improper repairs to the product, (v) use by you of defective or improper components or parts in servicing or repairing the product, or (vi) modification of the product in any way not expressly authorized by YSI.

THIS WARRANTY IS IN LIEU OF ALL OTHER WARRANTIES, EXPRESSED OR IMPLIED, INCLUDING ANY WARRANTY OF MERCHANTABILITY OR FITNESS FOR A PARTICULAR PURPOSE. YSI's LIABILITY UNDER THIS WARRANTY IS LIMITED TO REPAIR OR REPLACEMENT OF THE PRODUCT, AND THIS SHALL BE YOUR SOLE AND EXCLUSIVE REMEDY FOR ANY DEFECTIVE PRODUCT COVERED BY THIS WARRANTY. IN NO EVENT SHALL YSI BE LIABLE FOR ANY SPECIAL, INDIRECT, INCIDENTAL OR CONSEQUENTIAL DAMAGES RESULTING FROM ANY DEFECTIVE PRODUCT COVERED BY THIS WARRANTY.

## AUTHORIZED U.S. SERVICE CENTERS

---

**Please visit [www.yei.com](http://www.yei.com) or contact YSI Technical Support for the nearest authorized service center.**

YSI Incorporated • Technical Support • Phone: +1 937 767-7241 • 800 897-4151 • Fax: 937 767-1058 • Email: [environmental@ysi.com](mailto:environmental@ysi.com)



## CLEANING INSTRUCTIONS

---

**NOTE: Before they can be serviced, equipment exposed to biological, radioactive, or toxic materials must be cleaned and disinfected.** Biological contamination is presumed for any instrument, probe, or other device that has been used with body fluids or tissues, or with wastewater. Radioactive contamination is presumed for any instrument, probe or other device that has been used near any radioactive source.

If an instrument, probe, or other part is returned or presented for service without a Cleaning Certificate, and if in our opinion it represents a potential biological or radioactive hazard, our service personnel reserve the right to withhold service until appropriate cleaning, decontamination, and certification has been completed. We will contact the sender for instructions as to the disposition of the equipment. Disposition costs will be the responsibility of the sender.

When service is required, either at the user's facility or at YSI, the following steps must be taken to insure the safety of our service personnel.

1. In a manner appropriate to each device, decontaminate all exposed surfaces, including any containers. 70% isopropyl alcohol or a solution of 1/4 cup bleach to 1-gallon tap water are suitable for most disinfecting. Instruments used with wastewater may be disinfected with .5% Lysol if this is more convenient to the user.
2. The user shall take normal precautions to prevent radioactive contamination and must use appropriate decontamination procedures should exposure occur.
3. If exposure has occurred, the customer must certify that decontamination has been accomplished and that no radioactivity is detectable by survey equipment.
4. Any product being returned to the YSI Repair Center, should be packed securely to prevent damage.
5. Cleaning must be completed and certified on any product before returning it to YSI.

## PACKING INSTRUCTIONS

---

1. Clean and decontaminate items to insure the safety of the handler.
2. Complete and include the Cleaning Certificate.
3. Place the product in a plastic bag to keep out dirt and packing material.
4. Use a large carton, preferably the original, and surround the product completely with packing material.
5. Insure for the replacement value of the product.

### Cleaning Certificate

Organization \_\_\_\_\_

Department \_\_\_\_\_

Address \_\_\_\_\_

City \_\_\_\_\_ State \_ Zip \_\_\_\_\_

Country \_\_\_\_\_ Phone \_\_\_\_\_

Model No. of Device \_ Lot Number \_\_\_\_\_

Contaminant (if known) \_\_\_\_\_

Cleaning Agent(s) used \_\_\_\_\_

Radioactive Decontamination Certified?

(Answer only if there has been radioactive exposure)

\_\_\_\_\_ Yes \_\_\_\_\_ No

Cleaning Certified By \_\_\_\_\_

Name

Date



## SECTION 14 ACCESSORIES AND REPLACEMENT PARTS

The following parts and accessories are available from YSI or any Franchise Dealer authorized by YSI.

<b>YSI ORDER NUMBER</b>	<b>DESCRIPTION</b>
YSI 5906	Replacement Membrane Cap Kit ( 6 each )
YSI 5238	Probe Reconditioning Kit
YSI 3161	Conductivity Calibration Solution 1,000 $\mu$ /cm (1 Quart)
YSI 3163	Conductivity Calibration Solution 10,000 $\mu$ /cm (1 Quart)
YSI 3165	Conductivity Calibration Solution 100,000 $\mu$ /cm (1 Quart)
YSI 3167	Conductivity Calibration Solution 1,000 $\mu$ /cm (8 pints)
YSI 3168	Conductivity Calibration Solution 10,000 $\mu$ /cm (8 pints)
YSI 3169	Conductivity Calibration Solution 50,000 $\mu$ /cm (8 pints)
YSI 5520	Carrying Case
YSI 118510	Replacement Probe & Cable Assembly (10 feet)
YSI 118522	Replacement Probe & Cable Assembly (25 feet)
YSI 118527	Replacement Probe & Cable Assembly (50 feet)
YSI 118519	Replacement Probe and Cable Assembly (100 feet)
YSI 038501	Replacement Front Case Cover
YSI 055242	Replacement Rear Case Cover
YSI 055244	Replacement Battery Cover Kit
YSI 055204	Replacement Case Gasket and Screw
YSI 055219	Storage Chamber Sponge
YSI 030156	Main Board Assembly
YSI 038213	Replacement Electrode Cleaning Brush



# APPENDIX A SPECIFICATIONS

---

## Operating Environment

Medium: fresh, sea, or polluted water and most other liquid solutions.

Temperature: -5 to +65 °C

Depth: 0 to 10, 0 to 25, 0 to 50, or 0 to 100 feet (depending on cable length)

**Storage Temperature:** -10 to +50 °C

**Material:** ABS, Stainless Steel, and other materials

## Dimensions:

Height:	9.5 inches	(24.13 cm)
Thickness:	2.2 inches	(5.6 cm)
Width:	3.5 inches max.	(8.89 cm)
Weight:	1.7 pounds (w/ 10' cable)	(.77 kg)
Display:	2.3"W x 1.5"L	(5.8cm W x 3.8cm L)

**Power:** 9 VDC -6 AA-size Alkaline Batteries (included)

Approximately 100 hours operation from each new set of batteries

**Water Tightness:** Meets or exceeds IP65 standards

*Extensive testing of the YSI Model 85 indicates the following typical performance:*

Measurement	Range	Resolution	Accuracy
Conductivity	0 to 499.9 µS/cm	0.1 µS/cm	± .5% FS
	0 to 4999 µS/cm	1.0 µS/cm	± .5% FS
	0 to 49.99 mS/cm	.01 mS/cm	± .5% FS
	0 to 200.0 mS/cm	0.1 mS/cm	± .5% FS
Salinity	0 to 80 ppt	.1 ppt	± 2%, or ± 0.1 ppt
Temperature	-5 to +65 °C	0.1 °C	± 0.1 °C (±1 lsd)
Dissolved Oxygen	0 to 200 % Air Sat.	0.1% Air Saturation	± 2% Air Saturation
	0 to 20 mg/L	0.01 mg/L	± 0.3 mg/L

**Adjustable Conductivity Reference Temperature:** 15°C to 25°C

**Adjustable Temperature Compensation Factor for Conductivity:** 0% to 4%

**Temperature Compensation:** Automatic

**Range:** Autoranging for Dissolved Oxygen

User selected or Autoranging for Conductivity



# APPENDIX B - TEMPERATURE CORRECTION DATA

## Temperature Correction Data for Typical Solutions

### A. Potassium Chloride \*\* (KCl)

Concentration: 1 mole/liter			Concentration: 1 x 10 <sup>-1</sup> mole/liter		
C	mS/cm	%/ C (to 25 C)	C	mS/cm	%/ C (to 25 C)
0	65.10	1.67	0	7.13	1.78
5	73.89	1.70	5	8.22	1.80
10	82.97	1.72	10	9.34	1.83
15	92.33	1.75	15	10.48	1.85
20	101.97	1.77	20	11.65	1.88
25	111.90	1.80	25	12.86	1.90
			30	14.10	1.93
			35	15.38	1.96
			37.5	16.04	1.98
			40	16.70	1.99
			45	18.05	2.02
			50	19.43	2.04

Concentration: 1 x 10 <sup>-2</sup> mole/liter			Concentration: 1 x 10 <sup>-3</sup> mole/liter		
C	mS/cm	%/ C (to 25 C)	C	mS/cm	%/ C (to 25 C)
0	0.773	1.81	0	0.080	1.84
5	0.892	1.84	5	0.092	1.88
10	1.015	1.87	10	0.105	1.92
15	1.143	1.90	15	0.119	1.96
20	1.275	1.93	20	0.133	1.99
25	1.412	1.96	25	0.147	2.02
30	1.553	1.99	30	0.162	2.05
35	1.697	2.02	35	0.178	2.07
37.5	1.771	2.03	37.5	0.186	2.08
40	1.845	2.05	40	0.194	2.09
45	1.997	2.07	45	0.210	2.11
50	2.151	2.09	50	0.226	2.13

\*\* Charts developed by interpolating data from International Critical Tables, Vol. 6, pp. 229-253, McGraw-Hill Book Co., NY.



**B. Sodium Chloride\* (NaCl)**

Saturated solutions at all temperatures			Concentration: 0.5 mole/liter		
C	mS/cm	%/ C (to 25 C)	C	mS/cm	%/ C (to 25 C)
0	134.50	1.86	0	25.90	1.78
5	155.55	1.91	5	29.64	1.82
10	177.90	1.95	10	33.61	1.86
15	201.40	1.99	15	37.79	1.90
20	225.92	2.02	20	42.14	1.93
25	251.30	2.05	25	46.65	1.96
30	277.40	2.08	30	51.28	1.99
			35	56.01	2.01
			37.5	58.40	2.02
			40	60.81	2.02
			45	65.65	2.04
			50	70.50	2.05

Concentration: $1 \times 10^{-1}$ mole/liter			Concentration: $1 \times 10^{-2}$ mole/liter		
C	mS/cm	%/ C (to 25 C)	C	mS/cm	%/ C (to 25 C)
0	5.77	1.83	0	0.632	1.87
5	6.65	1.88	5	0.731	1.92
10	7.58	1.92	10	0.836	1.97
15	8.57	1.96	15	0.948	2.01
20	9.60	1.99	20	1.064	2.05
25	10.66	2.02	25	1.186	2.09
30	11.75	2.04	30	1.312	2.12
35	12.86	2.06	35	1.442	2.16
37.5	13.42	2.07	37.5	1.508	2.17
40	13.99	2.08	40	1.575	2.19
45	15.14	2.10	45	1.711	2.21
50	16.30	2.12	50	1.850	2.24

Concentration: $1 \times 10^{-3}$ mole/liter		
C	mS/cm	%/ C (to 25 C)
0	0.066	1.88
5	0.076	1.93
10	0.087	1.98
15	0.099	2.02
20	0.111	2.07
25	0.124	2.11
30	0.137	2.15
35	0.151	2.19
37.5	0.158	2.20
40	0.165	2.22
45	0.180	2.25
50	0.195	2.29

\* Charts developed by interpolating data from the CRC Handbook of Chemistry and Physics, 42nd ed., p. 2606, The Chemical Rubber Company, Cleveland.

**C. Lithium Chloride\* (LiCl)**

Concentration: 1 mole/liter			Concentration: 1 x 10 <sup>-1</sup> mole/liter		
C	mS/cm	%/ C (to 25 C)	C	mS/cm	%/ C (to 25 C)
0	39.85	1.82	0	5.07	1.87
5	46.01	1.85	5	5.98	1.85
10	52.42	1.89	10	6.87	1.85
15	59.07	1.92	15	7.75	1.85
20	65.97	1.95	20	8.62	1.85
25	73.10	1.98	25	9.50	1.86
30	80.47	2.02	30	10.40	1.88
35	88.08	2.05	35	11.31	1.91
37.5	91.97	2.07	37.5	11.78	1.92
40	95.92	2.08	40	12.26	1.94
45	103.99	2.11	45	13.26	1.98
50	112.30	2.15	50	14.30	2.02

Concentration: 1 x 10 <sup>-2</sup> mole/liter			Concentration: 1 x 10 <sup>-3</sup> mole/liter		
C	mS/cm	%/ C (to 25 C)	C	mS/cm	%/ C (to 25 C)
0	0.567	1.88	0	0.059	1.93
5	0.659	1.92	5	0.068	2.03
10	0.755	1.96	10	0.078	2.12
15	0.856	2.00	15	0.089	2.19
20	0.961	2.04	20	0.101	2.25
25	1.070	2.08	25	0.114	2.28
30	1.183	2.12	30	0.127	2.31
35	1.301	2.16	35	0.140	2.32
37.5	1.362	2.18	37.5	0.147	2.32
40	1.423	2.20	40	0.154	2.31
45	1.549	2.24	45	0.166	2.29
50	1.680	2.28	50	0.178	2.25

**D. Potassium Nitrate\*\* (KNO<sub>3</sub>)**

Concentration: 1 x 10 <sup>-1</sup> mole/liter			Concentration: 1 x 10 <sup>-2</sup> mole/liter		
C	mS/cm	%/ C (to 25 C)	C	mS/cm	%/ C (to 25 C)
0	6.68	1.78	0	0.756	1.77
5	7.71	1.79	5	0.868	1.80
10	8.75	1.81	10	0.984	1.83
15	9.81	1.83	15	1.105	1.86
20	10.90	1.85	20	1.229	1.88
25	12.01	1.87	25	1.357	1.90
30	13.15	1.90	30	1.488	1.93
35	14.32	1.92	35	1.622	1.95
37.5	14.92	1.94	37.5	1.690	1.96
40	15.52	1.95	40	1.759	1.97
45	16.75	1.97	45	1.898	1.99
50	18.00	2.00	50	2.040	2.01

\* Charts developed by interpolating data from the CRC Handbook of Chemistry and Physics, 42nd ed., p. 2606, The Chemical Rubber Company, Cleveland.

\*\* Charts developed by interpolating data from International Critical Tables, Vol. 6, pp. 229-253, McGraw-Hill Book Co., NY.

**E. Ammonium Chloride\* (NH<sub>4</sub>Cl)**

Concentration: 1 mole/liter			Concentration: 1 x 10 <sup>-1</sup> mole/liter		
C	mS/cm	%/ C (to 25 C)	C	mS/cm	%/ C (to 25 C)
0	64.10	1.60	0	6.96	1.82
5	74.36	1.53	5	7.98	1.88
10	83.77	1.45	10	9.09	1.93
15	92.35	1.37	15	10.27	1.97
20	100.10	1.29	20	11.50	2.00
25	107.00	1.21	25	12.78	2.03
			30	14.09	2.06
			35	15.43	2.07
			37.5	16.10	2.08
			40	16.78	2.08
			45	18.12	2.09
			50	19.45	2.09

Concentration: 1 x 10 <sup>-2</sup> mole/liter			Concentration: 1 x 10 <sup>-3</sup> mole/liter		
C	mS/cm	%/ C (to 25 C)	C	mS/cm	%/ C (to 25 C)
0	0.764	1.84	0	0.078	1.88
5	0.889	1.86	5	0.092	1.90
10	1.015	1.88	10	0.105	1.91
15	1.144	1.91	15	0.119	1.93
20	1.277	1.94	20	0.133	1.95
25	1.414	1.97	25	0.148	1.98
30	1.557	2.02	30	0.162	2.01
35	1.706	2.06	35	0.178	2.04
37.5	1.782	2.08	37.5	0.186	2.06
40	1.860	2.10	40	0.194	2.07
45	2.020	2.14	45	0.210	2.11
50	2.186	2.18	50	0.227	2.15

\* Charts developed by interpolating data from the CRC Handbook of Chemistry and Physics, 42nd ed., p. 2606, The Chemical Rubber Company, Cleveland.

## APPENDIX C REQUIRED NOTICE

---

The Federal Communications Commission defines this product as a computing device and requires the following notice:

This equipment generates and uses radio frequency energy and if not installed and used properly, may cause interference to radio and television reception. There is no guarantee that interference will not occur in a particular installation. If this equipment does cause interference to radio or television reception, which can be determined by turning the equipment off and on, the user is encouraged to try to correct the interference by one or more of the following measures:

- re-orient the receiving antenna
- relocate the computer with respect to the receiver
- move the computer away from the receiver
- plug the computer into a different outlet so that the computer and receiver are on different branch circuits.

If necessary, the user should consult the dealer or an experienced radio/television technician for additional suggestions. The user may find the following booklet, prepared by the Federal Communications Commission, helpful: "How to Identify and Resolve Radio-TV Interference Problems." This booklet is available from the U.S. Government Printing Office, Washington, D.C. 20402, Stock No. 0004-000-00345-4.



## APPENDIX D CONVERSION CHART

---

<b>TO CONVERT FROM</b>	<b>TO</b>	<b>EQUATION</b>
Feet	Meters	Multiply by 0.3048
Meters	Feet	Multiply by 3.2808399
Degrees Celsius	Degrees Fahrenheit	$(9/5 \text{ } ^\circ\text{C})+32$
Degrees Fahrenheit	Degrees Celsius	$5/9 \text{ } (^\circ\text{F}-32)$
Milligrams per liter (mg/l)	Parts per million (ppm)	Multiply by 1



## APPENDIX E OXYGEN SOLUBILITY TABLE

Table A: Solubility of Oxygen in mg/l in Water Exposed to Water-Saturated Air at 760 mm Hg Pressure.

Salinity = Measure of quantity of dissolved salts in water.

Chlorinity = Measure of chloride content, by mass, of water.

$$S(^{0}/_{00}) = 1.80655 \times \text{Chlorinity } (^{0}/_{00})$$

Temp °C	Chlorinity:0 Salinity:0	5.0 ppt 9.0 ppt	10.0 ppt 18.1 ppt	15.0 ppt 27.1 ppt	20.0 ppt 36.1 ppt	25.0 ppt 45.2 ppt
0.0	14.62	13.73	12.89	12.10	11.36	10.66
1.0	14.22	13.36	12.55	11.78	11.07	10.39
2.0	13.83	13.00	12.22	11.48	10.79	10.14
3.0	13.46	12.66	11.91	11.20	10.53	9.90
4.0	13.11	12.34	11.61	10.92	10.27	9.66
5.0	12.77	12.02	11.32	10.66	10.03	9.44
6.0	12.45	11.73	11.05	10.40	9.80	9.23
7.0	12.14	11.44	10.78	10.16	9.58	9.02
8.0	11.84	11.17	10.53	9.93	9.36	8.83
9.0	11.56	10.91	10.29	9.71	9.16	8.64
10.0	11.29	10.66	10.06	9.49	8.96	8.45
11.0	11.03	10.42	9.84	9.29	8.77	8.28
12.0	10.78	10.18	9.62	9.09	8.59	8.11
13.0	10.54	9.96	9.42	8.90	8.41	7.95
14.0	10.31	9.75	9.22	8.72	8.24	7.79
15.0	10.08	9.54	9.03	8.54	8.08	7.64
16.0	9.87	9.34	8.84	8.37	7.92	7.50
17.0	9.67	9.15	8.67	8.21	7.77	7.36
18.0	9.47	8.97	8.50	8.05	7.62	7.22
19.0	9.28	8.79	8.33	7.90	7.48	7.09
20.0	9.09	8.62	8.17	7.75	7.35	6.96
21.0	8.92	8.46	8.02	7.61	7.21	6.84
22.0	8.74	8.30	7.87	7.47	7.09	6.72
23.0	8.58	8.14	7.73	7.34	6.96	6.61



Temp °C	Chlorinity:0 Salinity:0	5.0 ppt 9.0 ppt	10.0 ppt 18.1 ppt	15.0 ppt 27.1 ppt	20.0 ppt 36.1 ppt	25.0 ppt 45.2 ppt
24.0	8.42	7.99	7.59	7.21	6.84	6.50
25.0	8.26	7.85	7.46	7.08	6.72	6.39
26.0	8.11	7.71	7.33	6.96	6.62	6.28
27.0	7.97	7.58	7.20	6.85	6.51	6.18
28.0	7.83	7.44	7.08	6.73	6.40	6.09
29.0	7.69	7.32	6.96	6.62	6.30	5.99
30.0	7.56	7.19	6.85	6.51	6.20	5.90
31.0	7.43	7.07	6.73	6.41	6.10	5.81
32.0	7.31	6.96	6.62	6.31	6.01	5.72
33.0	7.18	6.84	6.52	6.21	5.91	5.63
34.0	7.07	6.73	6.42	6.11	5.82	5.55
35.0	6.95	6.62	6.31	6.02	5.73	5.46
36.0	6.84	6.52	6.22	5.93	5.65	5.38
37.0	6.73	6.42	6.12	5.84	5.56	5.31
38.0	6.62	6.32	6.03	5.75	5.48	5.23
39.0	6.52	6.22	5.98	5.66	5.40	5.15
40.0	6.41	6.12	5.84	5.58	5.32	5.08
41.0	6.31	6.03	5.75	5.49	5.24	5.01
42.0	6.21	5.93	5.67	5.41	5.17	4.93
43.0	6.12	5.84	5.58	5.33	5.09	4.86
44.0	6.02	5.75	5.50	5.25	5.02	4.79
45.0	5.93	5.67	5.41	5.17	4.94	4.72

\* This table is provided for your information only. It is **NOT** required when calibrating the Model 85 in accordance with the instructions outlined in the section entitled Calibration.

## APPENDIX F CALIBRATION VALUES TABLE

Table A: Calibration values for various atmospheric pressures and altitudes.

Note: This table is for your information only. It is not required for calibration.

Pressure Inches of Hg	Pressure mm Hg	Pressure kPA	Altitude in feet	Altitude in meters	Calibration Value in %
30.23	768	102.3	-276	-84	101
29.92	760	101.3	0	0	100
29.61	752	100.3	278	85	99
29.33	745	99.3	558	170	98
29.02	737	98.3	841	256	97
28.74	730	97.3	1126	343	96
28.43	722	96.3	1413	431	95
28.11	714	95.2	1703	519	94
27.83	707	94.2	1995	608	93
27.52	699	93.2	2290	698	92
27.24	692	92.2	2587	789	91
26.93	684	91.2	2887	880	90
26.61	676	90.2	3190	972	89
26.34	669	89.2	3496	1066	88
26.02	661	88.2	3804	1160	87
25.75	654	87.1	4115	1254	86
25.43	646	86.1	4430	1350	85
25.12	638	85.1	4747	1447	84
24.84	631	84.1	5067	1544	83
24.53	623	83.1	5391	1643	82
24.25	616	82.1	5717	1743	81
23.94	608	81.1	6047	1843	80
23.62	600	80.0	6381	1945	79
23.35	593	79.0	6717	2047	78
23.03	585	78.0	7058	2151	77
22.76	578	77.0	7401	2256	76
22.44	570	76.0	7749	2362	75
22.13	562	75.0	8100	2469	74
21.85	555	74.0	8455	2577	73
21.54	547	73.0	8815	2687	72
21.26	540	71.9	9178	2797	71
20.94	532	70.9	9545	2909	70
20.63	524	69.9	9917	3023	69
20.35	517	68.9	10293	3137	68



*Y S I incorporated*



1700/1725 Brannum Lane  
Yellow Springs, Ohio 45387  
+1 937 767-7241  
800 765-4974 (US)  
FAX (937) 767-9353  
E-mail: [environmental@YSI.com](mailto:environmental@YSI.com)  
Website: [www.YSI.com](http://www.YSI.com)

ITEM # 038503  
DRW # A38503 - Web  
Revision E - Web  
November 1998



## STANDARD OPERATING PROCEDURE

### MAINE VOLUNTEER RIVER MONITORING PROGRAM

#### METHODS FOR USING THE OAKTON WATERPROOF ECTestr 11+ (PLUS) FOR MEASURING SPECIFIC CONDUCTANCE IN RIVERS AND STREAMS



**Note:** The mention of brand names does not constitute recommendation of a specific company.



## Volunteer River Monitoring Program

### Standard Operating Procedure Methods for using the Oakton Waterproof ECTestr 11+ (PLUS) for Measuring Specific Conductance in Rivers and Streams

**1. Applicability.** This standard operating procedure (SOP) is used by the Volunteer River Monitoring Program (VRMP) of the Maine Department of Environmental Protection's (DEP's) Bureau of Water Quality, Division of Environmental Assessment, Watershed Management Unit. It applies to the collection of specific conductance using an Oakton ECTestr 11+ (PLUS) by volunteers from rivers and streams in Maine. (*Note:* This meter is also capable of measuring water temperature. However, since this meter requires periodic calibration of the temperature-measurement device, volunteers are asked to not use the temperature values obtained by this device but rather from their dissolved oxygen meter or thermometer instead.)

**2. Purpose.** The purpose of this SOP is to provide standardized methods for volunteer groups to determine specific conductance of rivers and streams as an instantaneous reading using the Oakton hand-held ECTestrs 11+ (PLUS) meter.

#### 3. Definitions.

**A. Oakton.** Manufacturer of water quality monitoring meters.

**B. Electrode.** Sensing device located at the end of a cable that is attached to the meter.

**C. Specific Conductance.** A measure of the ability of a water solution to conduct an electrical current. Specific conductance is electrical conductivity (EC) that is being expressed in microsiemens per centimeter ( $\mu\text{s}/\text{cm}$ ) at a normalized temperature of 25 °C. Specific conductance is related to the type and concentration of ions in solution and can be used for approximating the dissolved-solids content of the water. Commonly, the concentration of dissolved solids (in mg/L) is about 65% of the specific conductance (in microsiemens). (*Note:* This relation is not constant from stream to stream, and it may vary in the same stream with changes in the composition of the water.)

#### 4. Responsibilities.

**A. Volunteer Monitors & Volunteer Groups**



- **Certification.** It is the responsibility of the individual obtaining this data to maintain current certification for the parameter(s) they collect if they wish their data to be entered into the VRMP database. Training will be provided to volunteers on an annual basis by VRMP/DEP staff, and certification will last for one year from the date of training.
- **Data recording.** It is the responsibility of the individual obtaining this data to record the results and additional qualifying information on current field sheets obtained from their affiliated watershed association or through the VRMP program of the DEP.
- **Data Quality Checks and Data Submission.** The data manager for the volunteer group will collect and enter volunteer field sheet data onto the appropriate computer file, perform quality assurance checks (refer to Section 5.10 of the Quality Assurance Program Plan), and submit data to the VRMP following protocols outlined in the volunteer group's latest sampling and analysis plan (SAP) that has been approved by the VRMP.

#### ***B. Volunteer River Monitoring Program (VRMP) Staff***

- **Oversight of Volunteer Groups and Volunteers.** VRMP staff will oversee volunteer groups and volunteers through a variety of ways including maintaining an up-to-date VRMP quality assurance project plan (QAPP); reviewing sampling and analysis plans (SAPs) of the volunteer groups; providing annual training/certification sessions for volunteers; conducting quality assurance checks on data submitted by volunteer groups and laboratories; and uploading data into the DEP's EGAD (Environmental and Geographic Analysis Database) database. These tasks are described in greater detail in the VRMP's latest QAPP.

### **5. Guidelines and Procedures.**

#### ***A. Oakton ECTestr 11+(PLUS) Meter Preparation.***

- **First time use.** Follow manufacturer's instructions for preparing meter for first time use. (Refer to Appendix A; sections "Before You Begin" through "HOLD Function").
- **Beginning of field season.** Before each field season, volunteer monitoring groups should conduct a full inspection of the meter. Follow manufacturer's instructions for first-time use (see above). New batteries shall be installed at the start of the sampling season and additionally, as needed. In addition, follow manufacturer's instructions for maintenance (Refer to Appendix A; section "Electrode Maintenance"). Each meter "setup" should be equipped with the following items:
  - Extra batteries
  - Field data sheet
  - Pencil with eraser



- **Prior to field sampling.** Before each field sample collection, the volunteer shall inspect the meter, including the condition of its electrode and batteries.
- **Calibration.** The Oakton ECTestr 11+ (PLUS) meter shall be calibrated at the beginning of the field season. When calibrating the Oakton ECTestr 11+ (PLUS), use the “Auto Calibration” and “1-point Calibration” modes, which are the factory-default modes. (Refer to Appendix A, sections “About Calibration” *through* “Auto Calibration”.)

## **B. EC Measurements.**

- **Sampling period and location.** Sampling period and site location information will be documented in volunteer groups’ SAPs (that require approval by the VRMP) which are submitted by the volunteer groups prior to the beginning of a sampling season. (Detailed information regarding how volunteer groups are to obtain and document site location information can be found in VRMP SOP-02 [Methods for Selecting and Documenting Site Locations].)
- **Familiarize Yourself with the Meter.** Volunteers shall familiarize themselves with the basic operation, keypad, and readouts of the meter (Appendix A; sections “Before You Begin” *through* “HOLD Function”).
- **Range Selection.** Volunteers shall ensure that Oakton EC 11+ (PLUS) Testr is set to “AUTO”- the default setting. (Refer to Appendix A, section “Range Selection”).
- **General Sampling Protocol.** (Refer to Appendix A, section “Measurement”).
  - (1) Record site location on data sheet.
  - (2) Remove electrode cap. Switch unit on.
  - (3) Dip electrode directly into stream or into a clean sample bottle/cup of the test solution. (“Clean” means that the sample container has been rinsed 3 times with stream water at your site.) Make sure sensor is fully covered by water.
  - (4) Wait for reading to stabilize (Automatic Temperature Compensation corrects for temperature changes.) Record reading.
  - (5) Replace electrode cap.
- **Quality Control**
  - (1) At the beginning of each field season, all VRMP staff and VRMP volunteers who will collect specific conductance data will have a training/refresher session to (re)familiarize themselves with the contents of this SOP.
  - (2) For every volunteer, a field duplicate shall be obtained for all parameters for at least 10% of their own sampling efforts. A field duplicate will be collected for every 10 samples monitored.
  - (3) Refer to the VRMP quality assurance project plan (QAPP) for more QA/QC details.





## **6. Equipment Care.**

### **A. *Start of field season.***

1. Follow manufacturer's directions for preparation of a new electrode at the start of the field season.
2. Use new batteries at start of each sampling season. An extra set of appropriate size batteries (4 1.5V alkaline batteries) should be included in the meter carrying case.
3. Each meter “setup” should include the following items:
  - a. Field datasheet
  - b. Pencil with eraser
  - c. Extra batteries

### **B. *Field Season.***

1. Always keep the sensor electrodes clean. Rinse the electrode with de-ionized water and wipe it dry with a clean cloth before storing with protective cap.
2. Ideally the meter should be in water-resistant case with padding to protect it from damage.
3. Allow the case and contents to air-dry at end of each day. This may be accomplished by simply propping lid open. When contents are very wet, remove the contents and spread out to facilitate drying.
4. Keep meter from freezing.
5. Never scratch electrodes with a hard substrate.
6. Replace all batteries if low battery indicator starts blinking, or if readings are faint or unstable.

### **C. *End of field season (also see Appendix A, section “Electrode Maintenance”).***

1. Completely dry meter, case, and all items in the case before storing.
2. Remove batteries.
3. Soak electrode in alcohol for a 10-15 minutes to remove oils.
4. Cover top of electrode with electrode cap to keep dust and dirt out for winter.
5. Keep meter dry and at room temperature to prevent corrosion of electronic parts.
6. Record winterization date and equipment repairs in Equipment Log.
7. Label the meter and case as ‘WINTERIZED’ in an obvious manner (so users will know the current status of the unit).

**D. *Miscellaneous.*** Refer to Appendix A, “Electrode Replacement”, if Testr fails to calibrate or gives fluctuating readings in calibration standards.



## 7. Specifications

Range	Range	Accuracy	Resolution
PU	0 - 200 $\mu\text{S}/\text{cm}$	$\pm 1\%$ full scale	0.1 $\mu\text{S}/\text{cm}$
LO	0 – 2000 $\mu\text{S}/\text{cm}$	$\pm 1\%$ full scale	1 $\mu\text{S}/\text{cm}$
HI	0 to 1990 $\mu\text{S}$	$\pm 1\%$ full scale	0.1 $\text{mS}/\text{cm}$

## 8. Appendix.

### A. Conductivity owner's manual:

Oakton®. 2006. Instruction Manual: Oakton® EC/TDS/SALT Testr: ECTestr 11+.  
Oakton Instruments, Illinois.

## 9. References.

### A. DEP Standard Operating Procedures:

- Document number #:DEPLW-0890: Dissolved Oxygen and Temperature, Instantaneous Measurement using Electronic Meters
- Document number#: DEPLW-0636: Protocols for using Hanna Dissolved Oxygen and Specific Conductance/Temperature/pH Meters

### B. Maine VRMP QAPP:

- Maine Department of Environmental Protection (MDEP). 2020. Maine Volunteer River Monitoring Program (VRMP) Quality Assurance Program Plan (QAPP). Portland, ME. DEPLW-0984.

**INSTRUCTION MANUAL**

**EC/TDS/SALT Testr**

**Large Screen Waterproof Multi Range  
Conductivity/TDS/Salt Tester  
with Temperature Display**

**Introduction**

Thank you for selecting microprocessor-based waterproof EC / TDS / SALT tester with large dual line display. You have one of the following models:

- ECTestr11
- ECTestr11+
- TDSestr11
- TDSestr11+
- SALTTestr11

**Non-plus models** (ECTestr11, TDSestr11 & SALTTestr11) come with user-replaceable two-pin type sensor and have many user friendly features such as Dual-range measurement, the Hold function, Automatic Temperature Compensation (ATC) and Self-Diagnostic Messaging capabilities.

**Plus models** (ECTestr11+ & TDSestr11+) come with the user-replaceable cup type sensor and have additional features such as Multi-range measurement, up to 3-point calibration and higher resolution measurement.

**Before You Begin**

Remove the electrode's protective cap. Soak the electrode for a few minutes in alcohol to remove any oil stains on the electrodes which will affect the accuracy of the tester. Rinse thoroughly with de-ionized water and shake off dry.

**Key Functions**

Key	Function
	- Power on and off the tester (The tester automatically switches off, if no button is pressed for 8.5 seconds)
	- In measurement mode, temperature reading switches between Celsius & Fahrenheit - In calibration mode, switches the tester to temperature calibration mode - In temperature calibration mode, exits calibration mode without confirming calibrated values
	- In measurement mode, switches to hold mode freezing the display. - In hold mode, switches back to measurement mode - In manual calibration and temperature calibration modes, exits calibration mode without confirming calibrated values - In range selection mode, selects a range
	- In measurement mode, enters calibration mode - In calibration mode, adjusts the calibration values - In hold mode, enters TDS factor setting mode - In TDS factor setting mode, adjusts TDS factor

**Note:** INC & DEC keys are located inside the battery compartment. Refer figure 1.

**Note:** For ECTestr11 & ECTestr11+ models, the caption of HOLD key is 'HOLD/ENT'

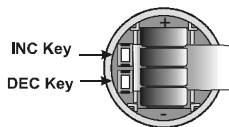


Figure 1: Battery compartment

**Switching On**

Press **ON/OFF** key to switch on the tester. The LCD shows the power-up sequence as illustrated in Figure 2. When the tester is on, if you do not press a key for 8.5 minutes, the tester automatically switches off to conserve batteries.

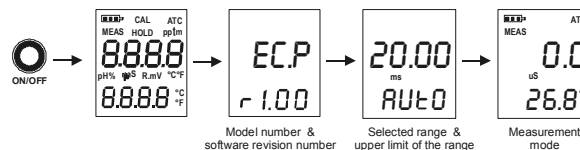


Figure 2: Power Up Sequence

**Range Selection**

Depending on the selected model, you can set the tester to limit its reading to a particular measuring range (PU, LO or HI) or full scale (AUTO). The default setting is AUTO. When you select a range other than AUTO, the tester can be calibrated only for that particular range. If you try to measure a sample which has a higher conductivity/TDS value than that of the selected measuring range, the LCD shows 'OR' error message. Refer **Specifications** section for available ranges of the selected model.

**To select a range:**

1. Switch off the tester. Press and hold **°C/°F** key and then switch on the tester using **ON/OFF** key. Release **°C/°F** key.
2. The tester goes to range selection mode. The LCD shows the currently selected Range (the default is AUTO) in the lower display. The upper display shows the maximum possible reading for the selected range. Press **HOLD** key repeatedly until you see the required range (PU, LO or HI).
3. The tester automatically confirms the last selection if no key is pressed for 5 seconds. Upper display momentarily shows 'CO'. The LCD shows power-up sequence and the tester goes to measurement mode.

**Note:** If no key is pressed within 5 seconds, LCD shows power-up sequence and tester goes to measurement mode.

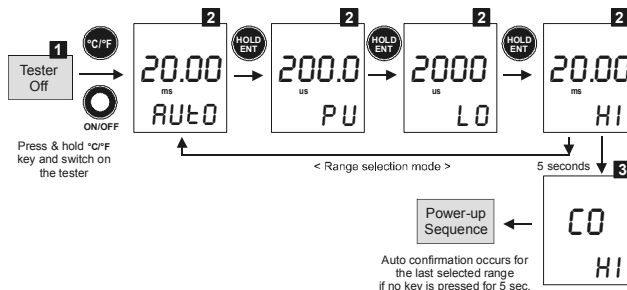


Figure 3: Range selection sequence from AUTO to HI for ECTestr11+

**Measurement**

1. Press the **ON/OFF** key to switch on the tester. The 'MEAS' indicators appears when the tester is in measurement mode.
2. Dip the electrode into the test solution making sure that it is fully immersed. Stir to clear any trapped air bubbles from the electrode and let the reading stabilize. For plus models, you can opt for the cup style measurement by filling the electrode cup with sample of test solution.

**Note:** The LCD indicates 'Or' (over range) if the reading is outside the selected range. If this occurs, select an appropriate range to suit the reading.

3. The upper display shows the main reading (conductivity/TDS/Salt) of the solution, automatically temperature compensated (ATC) to normalized temperature of 25°C. The lower display shows the temperature of the solution.

**HOLD Function**

This feature lets you freeze the display for a delayed observation.

1. Press **HOLD** key to freeze the measurement. The tester goes to hold mode and 'HOLD' indicator is displayed in LCD. The measurements are frozen and the 'MEAS' indicator disappears.
2. Press **HOLD** key again to release the measurement. The 'HOLD' indicator is no longer displayed. The tester goes back to measurement mode.

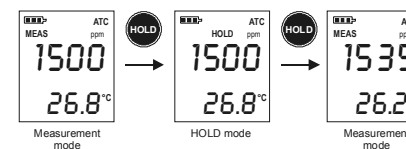


Figure 4: HOLD Function

**Temperature Unit of Measurement Selection**

This feature lets you set the unit of measurement of temperature to either Celsius (°C) or Fahrenheit (°F).

When the tester is in the measurement mode, press **°C/°F** button. The temperature display toggles between the Celsius and Fahrenheit reading.

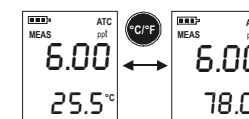


Figure 5: Temperature unit of measurement selection

## About Calibration

To ensure higher accuracy, the tester must be calibrated on a regular basis. Calibration can be manual or automatic (only for ECTestr11 & ECTestr11+); calibration can be 1-point or multi-point. You can choose any combination of the above two options for calibration. If you calibrate the tester for 1-point, the calibration is applied for all the measuring ranges. In applications where you need higher accuracy, and when you intend to measure values in more than one range, it is recommended to select multi-point calibration.

## Selection of Automatic or Manual Calibration

ECTestr11 & ECTestr11+ models support both automatic & manual calibration while all other models have to be calibrated manually. In automatic calibration, the tester automatically detects and verifies known conductivity standard solutions (84uS, 1413uS & 12.88mS). In manual calibration, you can use non-standard solutions which may be specific for your application.

The factory default is Automatic calibration (Auto). You can enable or disable automatic calibration as described below (for only ECTestr11 & ECTestr11+ models).

## Selection of 1-point or Multi-point Calibration

The factory default is 1-point Calibration. For higher accuracy, it is recommended that you calibrate the tester for multiple ranges if you intend to measure values in multiple ranges. You can enable or disable multi-point calibration as described below.

**Note:** If you have selected a specific measuring range for the tester, selecting multi-point calibration has no meaning, as the tester can only be calibrated for 1-point for the selected range. Set the tester to 'AUTO' measuring range if you wish to calibrate multi-points.

### To enable/disable auto calibration and multi-point calibration:

1. Switch off the tester. Press and hold **INC** key and then switch on the tester using **ON/OFF** key.
2. The tester goes to auto calibration selection mode. The lower display shows 'A.CAL' and the upper display blinks the current choice ('Yes' or 'No').

**Note:** This mode is available only for ECTestr11 & ECTestr11+ models. For other models, go directly to 1-point selection mode, described in step 4 below.

Press **INC** or **DEC** key to select 'Yes' (to enable auto calibration) or 'No' (to disable auto calibration)

**Note:** Press **°C/°F** key, if you wish to skip this setting without confirming changes.

**Note:** Press **°C/°F** key twice, if you wish to return to measurement mode without confirming changes.

3. Press **HOLD/ENT** key to confirm the selection. The display shows 'CO'.
4. The tester goes to 1-point calibration selection mode. The lower display shows '1.Pnt' and the upper display blinks the current choice ('Yes' or 'No'). Press **INC** or **DEC** key to select 'Yes' (to enable 1-point calibration) or 'No' (to disable 1-point calibration, i.e. to enable multi-point calibration).

**Note:** Press **°C/°F** key if you wish to skip this setting without confirming.

5. Press **HOLD/ENT** key to confirm the selection. The display shows 'CO' for few seconds and then shows power-up sequence. The tester goes to measurement mode.

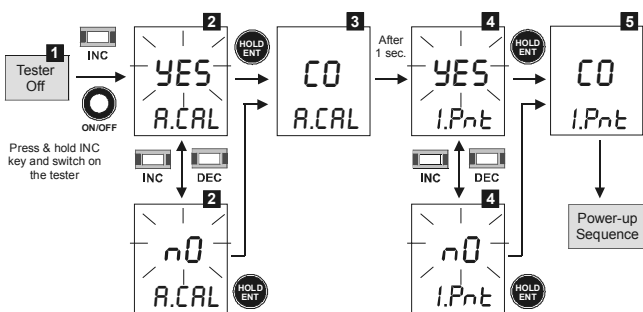


Figure 6: Selecting auto calibration & 1-point calibration for ECTestr11+

## Auto Calibration

Auto calibration feature is available only for conductivity in ECTestr11 & ECTestr11+ models. Make sure that 'auto calibration' is enabled as described in the previous section. Auto calibration is suitable if you use standard conductivity solutions for calibration process.

If you selected 1-point calibration, you need to choose a calibration standard corresponds to the selected measuring range of the tester listed below. If you have selected multi-point calibration & AUTO measuring range, you can choose any of the calibration standards listed below. During auto calibration, the tester recognizes the calibration standard if its value is within 50% tolerance. For multi-point calibration (with AUTO measuring range), the tester automatically scans through all possible calibration points until all of them are calibrated.

Selected Measuring Range	Calibration Standard
PU (0 to 200.0 uS/cm)	84 uS
LO (0 to 2000 uS/cm)	1413 uS
HI (0 to 20.00 mS/cm)	12.88 mS
AUTO	84 uS, 1413 uS, 12.88 mS

### To prepare calibration standards:

Use fresh calibration standard solutions listed in the above table. Prepare each solution in two beakers - one for rinsing and the other for calibration. Rinse the electrode in de-ionized water before calibration.

### To begin automatic calibration:

1. Switch on the tester. Make sure the tester is in measuring mode. Press **INC** or **DEC** key to enter conductivity calibration mode.
2. 'CAL' indicator appears in LCD. The display briefly shows 'CAL' and the number of points the tester will be calibrated.
3. The upper display shows the conductivity reading and the lower display sequentially shows calibration standard values 1413 uS & 12.88 mS (for ECTestr11) or 84 uS, 1413 uS & 12.88 mS (for ECTestr11+) if the measuring range of the tester is set to AUTO.

**Note:** If you have selected a specific measuring range for the tester, the lower display shows the corresponding calibration standard value that matches the selected measuring range.

4. Rinse the electrode with the calibration standard that you intend to calibrate and then dip the electrode in the other beaker with same calibration standard. Swirl gently to create a homogenous sample and allow time for the reading to stabilize.

**Note:** For multi-point calibration, the lower display automatically locks at the calibration standard value that closely matches. The tolerance range is  $\pm 50\%$  of the calibration standard. The tester shows error message 'Er.1' if you try to calibrate with a solution whose conductivity is outside the tolerance range.

**Note:** Press **INC** or **DEC** key if you wish to exit from auto calibration, during any of the above steps.

5. Press **HOLD/ENT** key to confirm the calibration. LCD shows 'CO' for 2 seconds. The calibration is complete and the tester returns to measurement mode, if this is a 1-point calibration.
6. For multi-point calibration, the tester goes to the next calibration point, lower display showing next calibration standard values. Rinse the electrode in de-ionized water and repeat step 4 & 5 to continue calibrating with next calibration standard solution.

**Note:** The tester shows error message 'Er.0' and returns to measuring mode if the temperature of the calibration solution is not within 0°C to 50°C.

**Note:** The tester shows error message 'Er.1' if you press **HOLD/ENT** key before the tester recognizes the calibration standard.

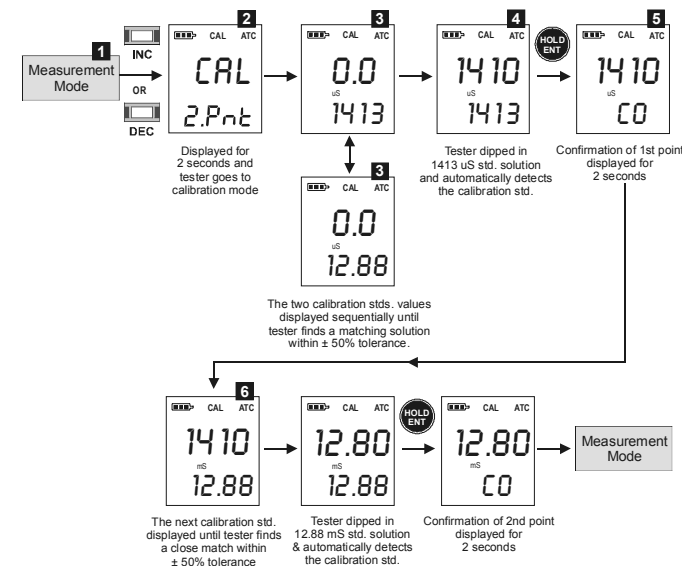


Figure 7: Two-point automatic calibration sequence for ECTestr11

## Manual Calibration

In manual calibration, the tester allows 1-point calibration for each measuring range. You can use customized calibration solutions with known conductivity/TDS values to calibrate the tester. The following table shows acceptable conductivity/TDS ranges of calibration solutions for each measuring range. Make sure your calibration solutions are within the given ranges.

Selected Measuring Range	Acceptable Calibration Standard Range	
	Conductivity	TDS/Salt
PU	2.0 - 200.0 uS/cm	2.0 - 200.0 ppm
LO	200 - 2000 uS/cm	200 - 2000 ppm
HI	2.00 - 20.00 mS/cm	1.00 - 10.00 ppt
AUTO	Select a calibration standard nearer to application sample	

### To prepare calibration standards:

Use fresh calibration solutions. Measure conductivity/TDS values of the solution with a meter known to be accurate. Prepare each solution in two beakers - one for rinsing and the other for calibration. Rinse the electrode in de-ionized water before calibration.

### To begin manual calibration:

- Switch on the tester. Make sure the tester is in measuring mode. Rinse the electrode with the calibration standard that you intend to calibrate and then dip the electrode in the other beaker with same calibration standard. Swirl gently to create a homogenous sample and allow time for the reading to stabilize.
- Press **INC** or **DEC** key to enter calibration mode. The 'CAL' indicator appears in LCD. The display briefly shows 'CAL' and the number of points the tester will be calibrated.
- The upper display shows the measured conductivity/TDS reading of the solution based on previous calibration (if any) and the lower display shows the default (uncalibrated) conductivity/TDS reading.

**Note:** The tester shows error message 'Er.1':

- If the reading is over range (Or) of selected measuring range of the tester, or
- If the default (uncalibrated) reading is not within the acceptable calibration standard range.

Use **INC** and **DEC** keys to adjust the upper display to the correct conductivity/TDS value of the calibration solution.

**Note:** The calibration adjustment window is  $\pm 50\%$  from the default reading.

**Note:** If you do not press **INC** or **DEC** key within 5 seconds, the tester shows the confirmation 'CO' and returns to the measurement mode. However, the tester is not calibrated to new values yet. The old calibration is still active. If this happens, press **INC** or **DEC** key once again to enter calibration mode.

- Wait for 5 seconds for the tester to automatically confirm the calibration by displaying 'CO' and return to the measurement mode.

**Note:** To exit calibration mode without confirming the calibration, press **HOLD/ENT** key before the automatic confirmation takes place.

**Note:** The tester shows error message 'Er.0' and returns to measuring mode if the temperature of the calibration solution is not within 0°C to 50°C.

- For multi-point calibration rinse the electrode in de-ionized water and repeat step the above steps with another standard solution.

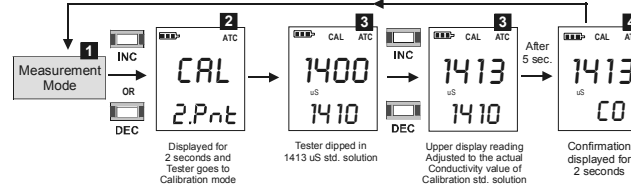


Figure 8: One-point manual calibration sequence for ECTestr11+

## TDS Factor Setting

TDS factor is only applicable for TDS11 & TDS11+ models.

The factory default TDS factor is 0.71. You can adjust the TDS factor to suit different samples of your applications.

### To change TDS factor:

- Switch on the tester. Make sure the tester is in measurement mode. Press **HOLD** key to bring the tester to the HOLD mode.
- Press **INC** or **DEC** key to enter the TDS factor setting mode.
- The upper & lower displays of LCD show the last configured TDS factor. The upper display is adjustable. Use the **INC** or **DEC** key to adjust the TDS factor. The adjustable range is 0.4 to 1.0

**Note:** If you do not press **INC** or **DEC** key within 5 seconds, the tester shows the confirmation 'CO' and returns to measurement mode.

- Wait for 5 seconds for the tester to automatically confirm the new setting by displaying 'CO' and return to the measurement mode.

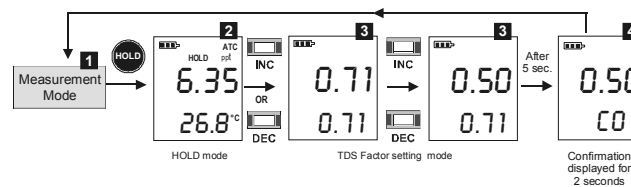


Figure 9: TDS Factor setting

## Temperature Calibration

Temperature calibration need not be performed every time, unless the temperature reading differs from that of an accurate thermometer. If temperature calibration is performed, Conductivity/TDS/Salt calibration is mandatory.

- Switch on the tester. Make sure the tester is in measuring mode. If required, press **°C/°F** key to select the desired unit of measurement for temperature (Celsius or Fahrenheit). Dip the tester into a solution of known temperature and allow time for the temperature reading to stabilize.
- Press **INC** or **DEC** key to bring the tester to the calibration mode. 'CAL' indicator appears in LCD. Immediately press **°C/°F** key to switch to the temperature calibration mode.

**Note:** When you enter calibration mode, if the conductivity/TDS/salt reading is outside the specified range (Or), the tester shows 'Er.1' error message. You can still proceed to the temperature calibration mode by pressing **°C/°F** key immediately. If the **°C/°F** key is not pressed within 2 seconds, the tester exits the calibration mode and returns to the measurement mode.

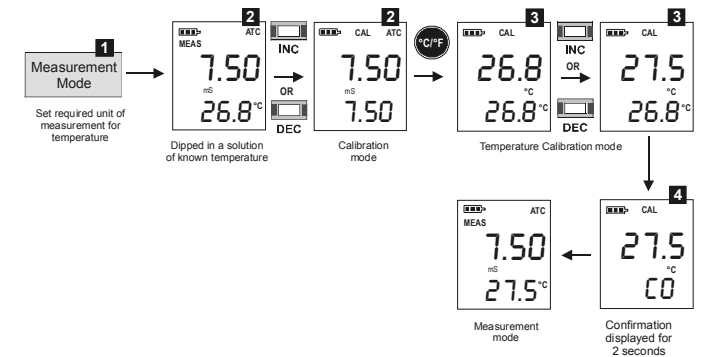


Figure 10: Temperature calibration sequence

- The upper display shows the measured temperature reading based on the last set offset (if any) and the lower display shows the default (uncalibrated) temperature reading based on factory settings. Use **INC** and **DEC** keys to adjust the upper temperature reading to the known temperature value of the solution.

**Notes:** The temperature adjustment window is  $\pm 5^\circ\text{C}$  ( $\pm 9^\circ\text{F}$ ) from the default reading.

- Wait for 5 seconds for the tester to automatically confirm the temperature calibration value by displaying 'CO' and return to the measurement mode.

**Note:** To exit temperature calibration mode without confirming the calibration, press **°C/°F** key or **HOLD/ENT** key before the automatic confirmation takes place.

**Note:** The tester shows error message 'Er.0' and returns to measuring mode if the temperature of the solution is not within 0°C to 50°C.

## Reset

Reset option allows you to restore the calibration and other parameters back to factory default settings.

1. Switch off the tester. Press and hold the **HOLD** key and then switch on the tester using **ON/OFF** key. Release **HOLD** key.
2. The lower display shows 'rSt' (reset) and the upper display blinks 'No'. Use **INC** or **DEC** key to select 'Yes' (to proceed with resting) or 'No' (to quit without resetting).

**Note:** Press °C/°F key if you wish to skip to measurement mode without making any selection.

3. Press **HOLD** key to confirm your selection. LCD shows 'CO'. If 'Yes' is selected, the tester resets to its factory default values as listed below. LCD shows power-up sequence and tester goes to measurement mode.

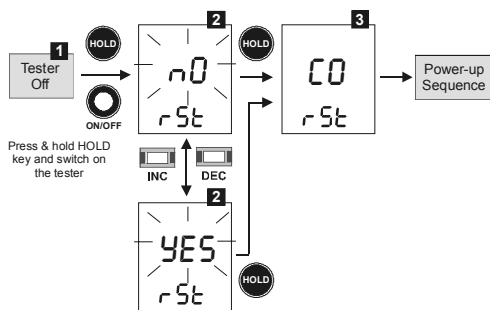


Figure 11: Resetting sequence

Parameter	Factory Default
User calibration (conductivity/TDS/salt)	(Reset)
Temperature unit of measurement	Celsius (°C)
Temperature offset	0
Auto calibration (for ECTestr11 & ECTester11+)	Enable
1-point calibration	Enable
Conductivity calibration factor (for ECTestr11 & ECTester11+)	1.0
TDS factor (for TDSTestr11 & TDSTester11+)	0.71

## Changing Batteries

Replace the batteries when the low battery indicator starts blinking.

1. Open the battery compartment lid (with attached lanyard loop).
2. Remove old batteries by pulling plastic ribbon. Replace with fresh ones. Note polarity as shown in figure 11.

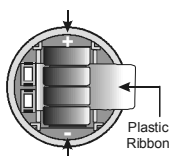


Figure 11: Battery compartment

## Electrode Maintenance

1. Always keep the sensor electrodes clean. Rinse the electrodes with de-ionized water and wipe them dry with clean cloth before storing with its protective cap. For cup type electrodes, remove the white plastic cup and insert to thoroughly clean viscous solutions. Never scratch electrodes with a hard substance.
2. For better performance, soak the electrode in alcohol for 10 to 15 minutes and rinse with de-ionized water before starting any measurement process. This is to remove dirt and oil stains on the electrode which may affect the accuracy of the measurements.

## Electrode Replacement

When the tester fails to calibrate or gives fluctuating readings in calibration standards, you need to change the electrode module. You can replace the electrode module at a fraction of the cost of a new tester.

1. With dry hands, grip the ribbed tester collar with electrode facing you. Twist the collar counter clockwise (see Figure 13-A). Save the ribbed tester collar and O-ring for later use.
2. Pull the old electrode module away from the tester.
3. Align the four tabs of the new electrode module so that they match the four slots on the tester (see Figure 13-B).
4. Gently push the module into the slots to sit it in position. Push the smaller O-ring fully onto the new electrode module. Push the collar over the module and thread it into place by firmly twisting clockwise.

**Note:** It is necessary that you recalibrate the tester prior to measurement after an electrode replacement.

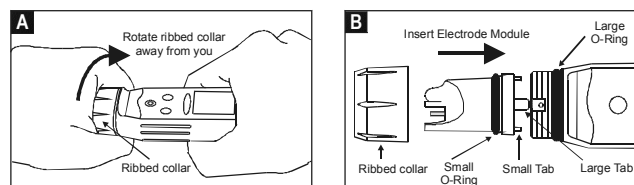


Figure 13: Removing collar & inserting electrode

## Self-Diagnostic Messages

Low battery indicator		3 Bars indicates Battery is full (100%)
		2 Bars indicates 50% of the battery life is left
		1 Bar indicates 25% of the battery life is left
Over range / Under range signal		Blinking battery casing indicates the need to replace batteries with fresh ones as specified by manufacturer
	<b>Or / Ur</b> (Still)	The sensor electrodes short circuited Replacement sensor is not connected properly to the tester during sensor replacement Measured value or temperature value exceeds the specified maximum or minimum value
	<b>ATC / Or / Ur</b> (Blinking)	Blinking 'ATC', 'Or' or 'Ur' indicates that there is a short or open circuit at the built in temperature sensor
Error Message	<b>Er0</b>	Calibration error due to temperature value not within the specified range
	<b>Er1</b>	Calibration error due to Conductivity/TDS/Salt value not within the specified calibration standard range

## Accessories

Item	Order Code
ECTESTR, TDSTESTR & SALTTESTR replacement sensor	TDSENSOR
ECTESTR+ & TDSTESTR+ replacement sensor	TDSENSORPLUS

## Warranty

The waterproof testers are warranted to be free from manufacturing defects for 1 year and electrode module for 6 months, unless otherwise specified. If repair, adjustment or replacement is necessary and has not been the result of abuse or misuse within the time period specified, please return the tester - freight prepaid - and correction will be made without charge. Out of warranty products will be repaired on a charge basis.

## Return of Items

Authorization must be obtained from your distributor before returning items for any reason.

When applying for authorization, please include information regarding the reason the item(s) are to be returned.

**Note:** Eutech Instruments/Dakton Instruments reserve the right to make improvements in design, construction and appearance of products without notice. Prices are subject to change without notice.

## Specifications

Model	ECTestr11	ECTestr11+	TDSTestr11	TDSTestr11+	SALTTestr11
Range:	PU LO 0 to 2000 uS/cm HI 0 to 20.00 mS/cm	- 0 to 200.0 uS/cm 0 to 2000 uS/cm 0 to 20.00 mS/cm	- 0 to 2000 ppm 0 to 20.00 ppt	0 to 200.0 ppm 0 to 2000 ppm 0 to 10.00 ppt	- 0 to 10.00 ppt
Resolution:	PU LO 10 uS/cm HI 0.10 mS/cm	- 0.1 uS/cm 1 uS/cm 0.01 mS/cm	- 10 ppm 0.10 ppt	0.1 ppm 1 ppm 0.01 ppm	- - 0.10 ppt
Accuracy	± 1% of Full Scale				
Calibration Type	Auto or Manual	Auto or Manual	Manual	Manual	Manual
Calibration Points	1 or 2 points	1, 2 or 3 points	1 or 2 points	1, 2 or 3 points	1 point
Calibration Window	± 50% from each point				
Calibration Standard Range:	PU LO 200 - 2000 uS/cm (Manual) HI 2.00 - 20.00 mS/cm	2.0 - 200.0 uS/cm 200 - 2000 uS/cm 2.00 - 20.00 mS/cm	- 200 - 2000 ppm 1.00 - 10.00 ppt	2.0 - 200.0 ppm 200 - 2000 ppm 1.00 - 10.00 ppt	- - 1.00 - 10.00 ppt
Sensor Type	Two-pin	Cup	Two-pin	Cup	Two-pin
TDS Factor	-	-	0.4 to 1.0 (Default 0.71)	-	-
Temperature	Range in °C 0.0 to 50.0°C Range in °F 32.0 to 122°F Resolution 0.1°C (0.1°F) Accuracy ±0.5°C (±0.9°F) Calibration point 1 point Calibration Window ± 50% (± 9°F) from factory default ATC 0 to 50°C Temp Coefficient 2% per °C Normalization Temp 25.0°C Auto Off 8.5 minutes after last key press				
Operating Temp	0 to 50°C				
Power Battery	4 X 1.5V'A76" micro alkaline battery				
Battery Life	>150 hrs				
LCD Display	Custom Dual Display 27mm(H)X21mm(W)				
Dimensions	Tester: 16.5 cm X 3.8 cm; 90g Boxed: 22cm X 6cm X 5cm; 170 g				



**STANDARD OPERATING PROCEDURE**  
**MAINE VOLUNTEER RIVER MONITORING PROGRAM**  
**METHODS FOR USING THE HACH 2100P**  
**TURBIDIMETER IN RIVERS AND STREAMS**



**Volunteer River Monitoring Program**  
**Standard Operating Procedure**  
**Methods for using the Hach 2100P Turbidimeter**

**1. Applicability.** This standard operating procedure is used by the Volunteer River Monitoring Program (VRMP) of the Maine Department of Environmental Protection's (DEP's) Bureau of Water Quality, Division of Environmental Assessment, Watershed Management Unit. It applies to the collection of turbidity (in NTU units) from rivers and streams in Maine using a Hach 2100P turbidimeter.

**2. Purpose.** The purpose of this SOP is to provide standardized methods for volunteer groups to determine turbidity of rivers and streams as an instantaneous reading using the Hach 2100P turbidimeter.

**3. Definitions.**

**A. Hach.** Manufacturer of water quality monitoring equipment.

**B. Calibration.** Set of procedures established by the manufacturer to ensure that the meter is operating properly; a critical quality assurance step in meter preparation prior to use.

**C. Standard Solutions.** The Hach 2100P turbidimeter is supplied with four sealed-vial StablCal® Stabilized Formazin Standards (<0.1-NTU, 20-NTU, 100-NTU, and 800-NTU) and are used to calibrate the turbidimeter.

**D. NTUs.** Nephelometric Turbidity Units. The units of measurement from a calibrated turbidity meter referred to as a nephelometer.

**4. Responsibilities.**

**A. Volunteer Monitors & Volunteer Groups**

- **Certification.** It is the responsibility of the individual obtaining this data to maintain current certification for the parameter(s) they collect if they wish their data to be entered into the VRMP database. Training will be provided to volunteers on an annual basis by VRMP/DEP staff, and certification will last for one year from the date of training.
- **Data recording.** It is the responsibility of the individual obtaining this data to record the results and additional qualifying information on current VRMP field sheets obtained from their affiliated watershed association or through the VRMP program of the DEP.



- **Data Quality Checks and Data Submission.** The data manager for the volunteer group will collect and enter volunteer field sheet data onto the appropriate computer file, perform quality assurance checks (refer to Section 5.10 of the Quality Assurance Program Plan), and submit data to the VRMP following protocols outlined in the volunteer group’s latest sampling and analysis plan (SAP) that has been approved by the VRMP.

#### ***B. Volunteer River Monitoring Program (VRMP) Staff***

- **Oversight of Volunteer Groups and Volunteers.** VRMP staff will oversee volunteer groups and volunteers through a variety of ways including maintaining an up-to-date VRMP quality assurance program plan (QAPP); reviewing sampling and analysis plans (SAPs) of the volunteer groups; providing annual training/certification sessions for volunteers; conducting quality assurance checks on data submitted by volunteer groups and laboratories; and uploading data into the DEP’s EGAD (Environmental and Geographic Analysis Database) database. These tasks are described in greater detail in the VRMP’s latest QAPP.

### **5. Guidelines and procedures**

#### ***A. Hach 2100P Turbidimeter Preparation:***

- **First time use.** Follow manufacturer’s instructions for preparing meter for first time use. (Refer to Appendix A; section 0 “Operation” and section 1 “Description” (topics: general description, accessories, principle of operation, preparation for use, etc.), pgs. 11 – 17).
- **Beginning of field season.** Before each field season, volunteer monitoring groups shall conduct a full inspection of the meter including sample cells and expiration dates of all turbidity standards. Sample cells should be clean and free from lint, fingerprints, dried spills, and significant scratches (refer to Appendix A; sections 2.3.1 “Cleaning Sample Cells” and 2.3.2 “Oiling the Sample Cell”, pg. 23-24 for more information about cleaning and oiling sample cells). New batteries shall be installed in the meter at the start of the sampling season and additionally, as needed (refer to Appendix A; section 1.4.2 “Battery Installation”, pg. 16).
- **Prior to field sampling.** Before each field sample collection, the volunteer shall inspect the meter including an inspection of the meter and sample cells for any defects, as well as the expiration dates of the turbidity standards.
- **Hach 2100P Turbidimeter Standard Use/Preparation and Calibration.** The Hach 2100P turbidimeter shall be calibrated at the beginning of each field season and at the beginning of each day of use. It is recommended by the manufacturer to use StablCal

Stabilized Formazin Standards for calibration with the Hach 2100P for more consistent results. All four sealed-vial standards that come with the meter (<0.1-NTU, 20-NTU, 100-NTU, and 800-NTU) will be used for calibrating the meter since they cover the approximate range of turbidity values that might be seen in Maine streams and rivers under various flow conditions.

- For instructions on storing, handling, and preparing the calibration standards, refer to Appendix A, sections:
  - 2.3.8 “Calibration” (pgs. 31-32);
  - 3.6 “Calibration” (pg. 37);
  - 3.6.1 “StablCal Stabilized Formazin Standards” (pg. 37);
  - 3.6.1.1 “Storing and Handling StablCal Stabilized Standards” (pgs. 37 – 38)
  - 3.6.1.3 “Preparing StablCal Stabilized Standards in Sealed Vials” (pg. 39).
- For instructions on calibrating the meter, refer to Appendix A, section 3.6.3 “Calibration: Calibrating the Turbidimeter” (pgs. 44 -48).

### ***B. Turbidity Measurements:***

- **Sample period and location.** Sampling period and site location will be documented in SAPs (that require approval by the VRMP) which are submitted by the volunteer groups prior to the beginning of a sampling season. (Detailed information regarding how volunteer groups are to obtain and document site location information can be found in VRMP SOP-02 [Methods for Selecting and Documenting Site Locations].)
- **Familiarize Yourself with the Meter.** Volunteers shall familiarize themselves with the basic operation, keypad, protocols for measurement, and readouts of the meter. In Appendix A, refer to the following sections:
  - Section 2 “Turbidity Measurement” (pgs. 19-32);
  - Section 3 “Operation” -- sub-sections 3.0 through 3.3 (pgs. 33-36).
- **General Sampling Protocol.**
  - Record site location on data sheet.
  - Follow the directions for filling sample cells with sample water, cleaning and oiling sample cells, for preparing to obtain turbidity measurements, as presented in Appendix A, section 2 “Turbidity Measurement” (pgs. 19 – 32).
    - VRMP volunteers will be not expected to follow the rigorous procedures outlined in section 2.3.5, “Removing Bubbles (Degassing)” (pgs. 28-30), to remove air bubbles that are trapped in their water sample. Volunteers should make a reasonable effort to dislodge air bubbles from the sample tubes (if any exist) by tapping the side of the cell – mindful to not scratch the tube (e.g., handle on the top of the tube; see pg. 23).
  - Collect water sample at the site where you are monitoring, as described in your group’s approved SAP. (Detailed information regarding how to collect a water

sample can be found in VRMP SOP-01 [Methods for Collecting Water Grab Samples in Rivers and Streams].)

- Follow the instructions specific to measuring turbidity below.

- **Turbidity Measurements.**

- (1) Review and follow the instructions for making turbidity measurements in section “Turbidity Measurement” (Appendix A, pg. 19 – 22). Make sure units are taken in NTU.

- **Quality Control:**

- (1) At the beginning of each field season, all VRMP staff and VRMP volunteers who will collect turbidity data will have a training/refresher/certification session to (re)familiarize themselves with the contents of this SOP.
- (2) For every volunteer, a field duplicate shall be obtained for all parameters for at least 10% of their own sampling efforts. A field duplicate will be collected for every 10 samples monitored.
- (3) Refer to the VRMP quality assurance program plan (QAPP) for more QA/QC details.

## 6. Equipment Care:

### A. *Start of Field Season.*

1. Follow manufacturer’s instructions for preparation of turbidimeter including sample cells.
  - Refer to Appendix A:
    - section 1.4 “Preparations for Use”(pg. 15-17);
    - section 2.3 “Measurement Techniques” (pg. 22 – 28), including:
      - 2.3.1 “Cleaning Sample Cells;
      - 2.3.2 “Oiling the Sample Cell”;
      - 2.3.3 “Orienting Sample Cells”
2. Use new batteries (sections 1.4.2 and 4.2) at start of sampling season. Extra sample cells and an extra set of appropriate size batteries should be included in the meter carrying case.

### B. *Field Season.*

1. Ideally the meter should be in a water-resistant case with padding to protect it from damage.
2. Allow the case and contents to air-dry at the end of each day. This may be accomplished by simply propping the protective’s case’s lid open. When contents are very wet, remove the contents and spread out to facilitate drying.
3. Clean sample cells at the end of each sampling day (refer to Appendix A; section 2.3.1 “Cleaning Sample Cells” [pg. 23]).

4. Keep meter from freezing.
5. Refer to Appendix A; section 4 “Maintenance”, pg. 59 - 65 for manufacturer’s recommendations for maintenance requirements.

**C. End of Field season.**

1. Completely dry meter and case and all items in the case before storing.
2. Remove batteries.
3. Clean sample cells according to manufacturer’s instructions (Refer to Appendix A; section 2.3.1 “Cleaning Sample Cells” [pg. 23]).
4. Keep meter dry and at room temperature to prevent corrosion of electronic parts.
5. Record winterization date and equipment repairs in Equipment Log.
6. Label the meter and case as “WINTERIZED” in an obvious manner (so users will know the current status of the unit.)

**7. Specifications**

Display	Range	Accuracy	Resolution
Turbidity (NTU)	0.00 – 1000 NTU	± 2% of readings plus stray light from 0 – 1000 NTU	0.01 NTU on lowest range

**8. Appendix.**

**A. Hach Turbidimeter 2100P owner’s manual:**

Hach Company. 2008. Instrument and Procedure Manual: Hach 2100P Portable Turbidimeter. Ames, IA.

**9. References.**

**A. Maine VRMP QAPP:**

- Maine Department of Environmental Protection (MDEP). 2020. Maine Volunteer River Monitoring Program (VRMP) Quality Assurance Program Plan (QAPP). Portland, ME. DEPLW-09



CAT. NO. 46500-88

**PORTABLE TURBIDIMETER**  
**Model 2100P**  
**Instrument and Procedure Manual**



# TABLE OF CONTENTS

---

<b>TABLE OF CONTENTS</b> .....	3
<b>CERTIFICATION</b> .....	5
<b>SAFETY PRECAUTIONS</b> .....	7
<b>SPECIFICATIONS</b> .....	9
<b>OPERATION</b> .....	11
<b>SECTION 1 DESCRIPTION</b> .....	13
1.1 General Description .....	13
1.2 Accessories .....	14
1.3 Principle of Operation .....	14
1.4 Preparation for Use .....	15
1.4.1 Unpacking .....	15
1.4.2 Battery Installation .....	16
1.4.3 Using the Battery Eliminator and Rechargeable Batteries... ..	16
1.4.4 Calibration .....	16
<b>SECTION 2 TURBIDITY MEASUREMENT</b> .....	19
2.1 Operating Controls and Indicators .....	19
2.2 Turbidity Measurement .....	19
2.2.1 Turbidity Measurement Procedure .....	20
2.2.2 Measurement Notes .....	22
2.3 Measurement Techniques .....	22
2.3.1 Cleaning Sample Cells .....	23
2.3.2 Oiling the Sample Cell .....	23
2.3.3 Orienting Sample Cells .....	24
2.3.4 Matching multiple sample cells .....	26
2.3.5 Removing Bubbles (Degassing) .....	28
2.3.6 Measuring Overrange Samples .....	31
2.3.7 Condensation (fogging) .....	31
2.3.8 Calibration .....	31
2.3.9 Representative Sampling .....	32

# TABLE OF CONTENTS, continued

---

<b>SECTION 3 OPERATION</b> .....	33
3.1 Operational Controls and Indicators .....	33
3.2 Using the Read Key .....	35
3.2.1 Continuous Reading .....	35
3.3 Using the Signal Averaging Key .....	35
3.4 Using the Range Selection Key .....	36
3.5 Restoring the Default Calibration .....	36
3.6 Calibration .....	37
3.6.1 StablCal Stabilized Formazin Standards .....	37
3.6.2 Formazin Primary Standards .....	40
3.6.3 Calibrating the Turbidimeter .....	44
3.6.4 Using Gelex® Secondary Turbidity Standards .....	54
<b>MAINTENANCE</b> .....	57
<b>SECTION 4 MAINTENANCE</b> .....	59
4.1 Cleaning .....	59
4.2 Battery Replacement .....	59
4.3 Lamp Replacement .....	59
<b>SECTION 5 TROUBLESHOOTING</b> .....	67
5.1 Using the Diagnostic Functions Key .....	67
5.1.1 Basic Diagnostic Codes .....	67
5.2 The Diagnostic Procedure .....	68
5.3 Other Instrument Diagnostics .....	70
5.3.1 Display Test .....	70
5.4 Error Messages .....	70
5.4.1 Flashing Numeric Display .....	70
5.4.2 E Messages .....	70
5.4.3 CAL? .....	70
<b>GENERAL INFORMATION</b> .....	73
<b>Replacement Parts &amp; Accessories</b> .....	74
<b>HOW TO ORDER</b> .....	76
<b>REPAIR SERVICE</b> .....	77
<b>WARRANTY</b> .....	78



# CERTIFICATION

---

Hach Company certifies this instrument was tested thoroughly, inspected and found to meet its published specifications when it was shipped from the factory.

The Model 2100P Portable Turbidimeter has been tested and is certified as indicated to the following instrumentation standards:

## **Product Safety**

### **Battery/Eliminator Power Supply Only:**

120 Vac, 60 Hz, UL Listed & CSA Certified, Class 2

230 Vac, 50 Hz, VDE Approved, GS & CE marked

## **Immunity**

### **2100P Turbidimeter Tested with external Battery/Eliminator**

#### **Power Supply:**

**EN 50082-1** (European Generic Immunity Standard) **per 89/336/EEC**

**EMC:** Supporting test records with Dash Straus and Goodhue, Inc.

(now Intertek Testing Services), certified compliance by

Hach Company.

#### **Standards include:**

IEC 801-2 Electro-Static Discharge

IEC 801-3 Radiated RF Electro-Magnetic Fields

IEC 801-4 Electrical Fast Transients/Burst

## **Emissions**

### **2100P Turbidimeter Tested with external Battery/Eliminator**

#### **Power Supply:**

**EN 50081-1** (Emissions) **per 89/336/EEC EMC:** Supporting test

records by Amador Corp. (now TUV Product Services), certified

compliance by Hach Company

#### **Standards include:**

EN 55022 (CISPR 22) Emissions, Class B Limits

### **Canadian Radio Interference-Causing Regulation, Chapter 1374,**

**Class A:** Supporting test records by Amador Corp. (now TUV Product Services), certified compliance by Hach Company

This Class A digital apparatus meets all requirements of the Canadian Interference-Causing Equipment Regulations.

Cet appareil numérique de la classe A respecte toutes les exigences du Règlement sur le matériel brouilleur du Canada.

## **CERTIFICATION, continued**

---

**FCC Part 15, Class “A” Limits:** Supporting test records by Amador Corp. (now TUV Product Services), certified compliance by Hach Company.

This device complies with Part 15 of the FCC Rules. Operation is subject to the following two conditions:

1. this device may not cause harmful interference, and
2. this device must accept any interference received, including interference that may cause undesired operation.

Changes or modifications to this unit not expressly approved by the party responsible for compliance could void the user’s authority to operate the equipment.

This equipment has been tested and found to comply with the limits for a Class A digital device, pursuant to Part 15 of the FCC Rules. These limits are designed to provide reasonable protection against harmful interference when the equipment is operated in a commercial environment. This equipment generates, uses, and can radiate radio frequency energy and, if not installed and used in accordance with the instruction manual, may cause harmful interference to radio communications. Operation of this equipment in a residential area may cause harmful interference in which case the user will be required to correct the interference at his own expense.

The following techniques of reducing interference problems are applied easily:

1. Disconnect the battery eliminator from its power source and from the 2100P Portable Turbidimeter to verify if it is the source of the interference
2. If the battery eliminator for the 2100P Portable Turbidimeter is plugged into the same outlet as the device with which it is interfering, try another outlet.
3. Move the 2100P Portable Turbidimeter away from the device receiving the interference.
4. Reposition the receiving antenna for the device receiving the interference.
5. Try combinations of the above.

# SAFETY PRECAUTIONS

---

Please read this entire manual before unpacking, setting up, or operating this instrument. Pay particular attention to all danger and caution statements. Failure to do so could result in serious injury to the operator or damage to the equipment.

To ensure the protection provided by this equipment is not impaired, do not use or install this equipment in any manner other than that which is specified in this manual.

## Use of Hazard Information

If multiple hazards exist, this manual will use the signal word (Danger, Caution, Note) corresponding to the greatest hazard.

### **DANGER**

*Indicates a potentially or imminently hazardous situation which, if not avoided, could result in death or serious injury.*

### **CAUTION**


*Indicates a potentially hazardous situation that may result in minor or moderate injury.*

### **NOTE**

*Information that requires special emphasis.*

## Precautionary Labels

Read all labels and tags attached to the instrument. Personal injury or damage to the instrument could occur if not observed.

 This symbol, if noted on the instrument, references the instruction manual for operational and/or safety information.



# SPECIFICATIONS

---

Specifications subject to change without notice.

Operating specifications applicable at 25 °C unless noted.

Program software copyrighted by Hach Company, 1991.

**Measurement Method:** Ratio Nephelometric signal (90°) scatter light ratio to transmitted light

**Range:** 0-1000 NTU with automatic decimal point placement or manual range selection of 0-9.99, 0-99.9 and 0-1000 NTU

**Accuracy:** ± 2% of reading plus stray light from 0-1000 NTU

**Resolution:** 0.01 NTU on lowest range

**Repeatability:** ±1% of reading or 0.01 NTU, whichever is greater (with Gelex standards)

**Response Time:** 6 seconds for full step change without signal averaging in constant reading mode

**Stray Light:** <0.02 NTU

**Standardization:** StablCal® Stabilized Formazin primary standards or Formazin primary standards

**Secondary Standards:** Gelex® Secondary Standards

**Display:** Four-digit liquid crystal; 10.16 mm (0.4 in) high digits with custom icons

**Light Source:** Tungsten filament lamp; lamp life typically greater than 100,000 readings

**Detectors:** Silicon photovoltaic

**Signal Averaging:** Operator selectable on or off

**Sample Cells:** (Height X width) 60.0 X 25 mm (2.36 X 1 in) Borosilicate glass with screw caps, marking band and fill line

**Sample Required:** 15 mL (0.5 oz.)

**Storage Temperature:** -40 to 60 °C (-40 to 140 °F) (instrument only)

## **SPECIFICATIONS, continued**

---

**Operating Temperature:** 0 to 50 °C (32 to 122 °F) (instrument only)

**Operating Humidity Range:** 0 to 90% RH noncondensing at 30 °C;  
0 to 80% RH noncondensing at 40 °C;  
0 to 70% RH noncondensing at 50 °C

**Power Requirements:** Four AA Alkaline cells or optional battery eliminator

**Battery Life:** Typically 300 tests with signal average mode off;  
180 tests with signal average mode on

**Battery Eliminator (optional):**

For 120 V eliminator: CSA and UL approved for 120 VAC  $\pm 10\%$ ,  
60 Hz, 6 V at 800 mA DC output

For 230 V eliminator: CE (VDE) approval pending for 230 VAC  
 $\pm 10\%$ , 50 Hz, 6 V at 900 mA DC output

**Enclosure:** High impact ABS plastic

**Dimensions:** 22.2 X 9.5 X 7.9 cm (8.75 X 3.75 X 3.12 in)

**Instrument Weight:** 520 kg (1 lb 2.5 oz)

**Shipping Weight:** 3.1 kg (6 lbs 8.5 oz)



## OPERATION

### **DANGER**

*Handling chemical samples, standards, and reagents can be dangerous. Review the necessary Material Safety Data Sheets and become familiar with all safety procedures before handling any chemicals.*

### **DANGER**

*La manipulation des échantillons chimiques, étalons et réactifs peut être dangereuse. Lire les Fiches de Données de Sécurité des Produits (FDSP) et se familiariser avec toutes les procédures de sécurité avant de manipuler tous les produits chimiques.*

### **PELIGRO**

*La manipulación de muestras químicas, estándares y reactivos puede ser peligrosa. Revise las fichas de seguridad de materiales y familiarícese con los procedimientos de seguridad antes de manipular productos químicos.*

### **GEFAHR**

*Das Arbeiten mit chemischen Proben, Standards und Reagenzien ist mit Gefahren verbunden. Es wird dem Benutzer dieser Produkte empfohlen, sich vor der Arbeit mit sicheren Verfahrensweisen und dem richtigen Gebrauch der Chemikalien vertraut zu machen und alle entsprechenden Materialsicherheitsdatenblätter aufmerksam zu lesen.*

### **PERIGO**

*A manipulação de amostras, padrões e reagentes químicos pode ser perigosa. Reveja a folha dos dados de segurança do material e familiarize-se com todos os procedimentos de segurança antes de manipular quaisquer produtos químicos.*

### **PERICOLO**

*La manipolazione di campioni, standard e reattivi chimici può essere pericolosa. La preghiamo di prendere conoscenza delle Schede Tecniche necessarie legate alla Sicurezza dei Materiali e di abituarsi con tutte le procedure di sicurezza prima di manipolare ogni prodotto chimico.*





# SECTION 1 DESCRIPTION

---

## 1.1 General Description

The Hach Model 2100P Portable Turbidimeter (*Figure 1*) measures turbidity from 0.01 to 1000 NTU in automatic range mode with automatic decimal point placement. The manual range mode measures turbidity in three ranges: 0.01 to 9.99, 10 to 99.9 and 100 to 1000 NTU. Designed primarily for field use, the microprocessor-based Model 2100P has the range, accuracy, and resolution of many laboratory instruments. The instrument operates on four AA batteries or with an optional battery eliminator. Rechargeable nickel-cadmium cells may be used, but cannot be recharged in the instrument. The instrument automatically shuts off after 5.5 minutes if no keystrokes occur (does not influence operation). If this occurs, simply turn the instrument on – the 2100P will resume operation as if the power had not been interrupted. The instrument, all standard accessories, and the optional battery eliminator may be conveniently stored in the carrying case.

**Figure 1**                      **2100P Turbidimeter and Accessories**



*Note:* Avoid prolonged exposure to ultraviolet light and sunlight.

*Note:* Do not hold the instrument during measurements; place the instrument on a flat, steady surface.

## SECTION 1, continued

---

### 1.2 Accessories

Accessories supplied with the turbidimeter include nine sample cells; three Gelex® Secondary Standards (included with 4650000 only); one sealed vial each of:

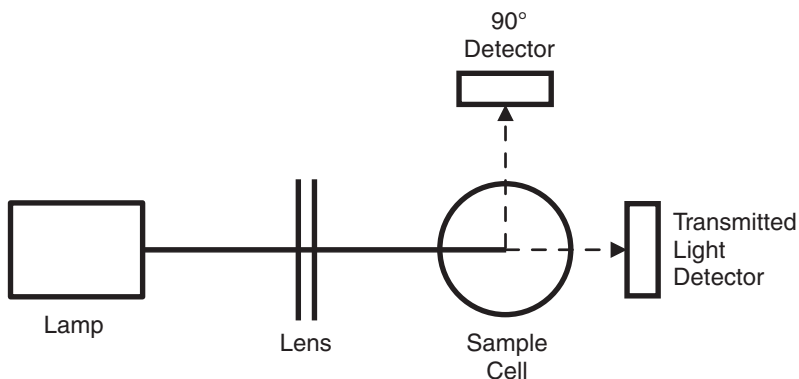
<0.1-NTU, 20-NTU, 100-NTU, and 800-NTU StablCal® Stabilized Formazin Standards; 4 AA alkaline batteries; 15 mL of silicone oil; oiling cloth; carrying case; instrument manual; and quick reference card.

### 1.3 Principle of Operation

The Model 2100P Portable Turbidimeter operates on the nephelometric principle of turbidity measurement. This instrument meets the design criteria specified by the United States Environmental Protection Agency, Method 180.1.

The optical system\* (*Figure 2*) includes a tungsten-filament lamp, a 90° detector to monitor scattered light and a transmitted light detector. The instrument's microprocessor calculates the ratio of the signals from the 90° and transmitted light detectors. This ratio technique corrects for interferences from color and/or light absorbing materials (such as activated carbon) and compensates for fluctuations in lamp intensity, providing long-term calibration stability. The optical design also minimizes stray light, increasing measurement accuracy.

**Figure 2**      **Ratio Optical System**



---

\* Patent number 4,198,161; other patents pending.

## SECTION 1, continued

---

### 1.4 Preparation for Use

#### 1.4.1 Unpacking

Remove the instrument and accessories from the shipping box and inspect them for damage that may have occurred due to rough handling or extreme weather conditions. Verify the following are present:

- Model 2100P Portable Turbidimeter
- Instrument Manual (with quick reference card)
- Set of StablCal Primary Standards in sealed vials, one each of:
  - <0.1 NTU\*
  - 20 NTU
  - 100 NTU
  - 800 NTU
- Standardization Kit containing Gelex Secondary Standards (0-10, 0-100 and 0-1000 ranges) (included with 4650000 only) plus nine sample cells with caps.
- Silicone Oil, 15-mL (0.5 oz) dropping bottle
- Oiling Cloth
- Carrying Case
- Four AA alkaline batteries

If any of the items are missing or damaged, please contact the Customer Service Department, Hach Company, Loveland, Colorado. The toll-free number in the United States is 800-227-4224. International customers should contact the Hach office or authorized distributor serving your area. Refer to *REPAIR SERVICE* on page 77. **Please do not return the instrument without prior authorization from Hach.**

---

\* Used in place of the dilution water standard when performing a calibration.

## SECTION 1, continued

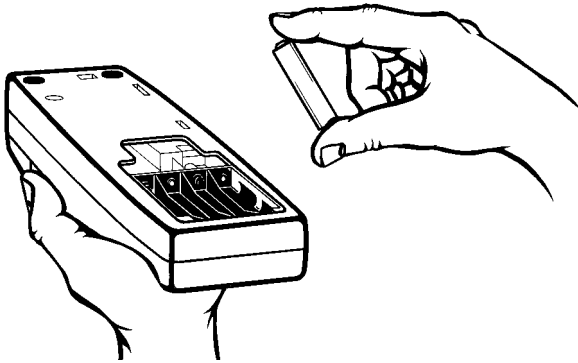
---



### 1.4.2 Battery Installation

The instrument is shipped completely assembled without the batteries installed. Before use, install the four AA alkaline batteries or connect the battery eliminator (*Figure 3*). For battery operation, remove the battery compartment cover on the instrument bottom and install the batteries. Correct battery polarity is shown on the battery holder. The instrument will not function if the batteries are not installed correctly. Reinstall the battery compartment cover.

Figure 3 Battery Installation



### 1.4.3 Using the Battery Eliminator and Rechargeable Batteries

For operation with the optional battery eliminator, plug the eliminator jack into the connector on the turbidimeter side. The battery eliminator may be used with or without the batteries installed. **The eliminator will not charge batteries.** Rechargeable batteries may be used in the instrument, but must be removed for recharging. See *HOW TO ORDER* on page 76 for ordering information. To prolong battery life, the instrument lamp turns on temporarily when the **READ** key is depressed. Batteries are not necessary for battery eliminator operation.

### 1.4.4 Calibration

The 2100P Portable Turbidimeter is calibrated with Formazin Primary Standard at the factory. However, the instrument should be calibrated upon receipt for best results. Hach recommends recalibration with

## **SECTION 1, continued**

---

formazin once every three months, or more often as experience dictates. The Gelex Secondary Standards supplied with the instrument (included with 4650000 only) are labelled with general ranges for application, but must be assigned values before use from formazin calibration. See *Section 3.6* on page 37 for calibration instructions.

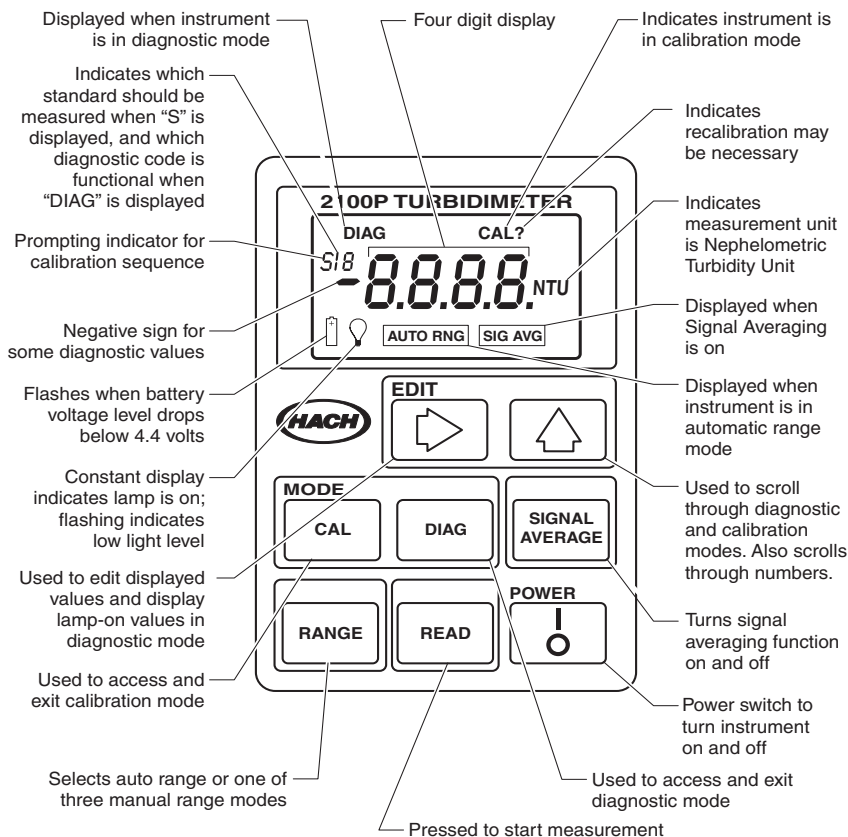


# SECTION 2 TURBIDITY MEASUREMENT

## 2.1 Operating Controls and Indicators

Figure 4 shows the 2100P controls and indicators. Refer to SECTION 3 for a detailed description of each control and indicator.

**Figure 4 Keyboard and Display with Descriptions**



## 2.2 Turbidity Measurement

Measurements may be made with the signal average mode on or off and in manual or automatic range selection mode. Using automatic range selection is recommended. Signal averaging uses more power and should be used only when the sample causes an unstable reading. Signal averaging measures and averages ten measurements while displaying

## SECTION 2, continued

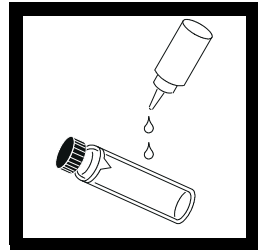
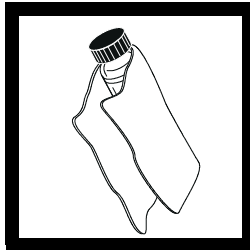
---

intermediate results. The initial value is displayed after about 11 seconds and the display is updated every 1.2 seconds until all ten measurements are taken (about 20 seconds). After this, the lamp turns off, but the final measured turbidity value continues to be displayed until another key is pressed.

When not in signal average mode, the final value is displayed after about 13 seconds.

Accurate turbidity measurement depends on good measurement technique by the analyst, such as using clean sample cells in good condition and removing air bubbles (degassing). Refer to *Section 2.3* on page 22 for a detailed discussion of measurement techniques.

### 2.2.1 Turbidity Measurement Procedure



**1.** Collect a representative sample in a clean container. Fill a sample cell to the line (about 15 mL), taking care to handle the sample cell by the top. Cap the cell. (See *Section 2.3* on page 22 for more information about collecting a representative sample).

**2.** Wipe the cell with a soft, lint-free cloth to remove water spots and fingerprints.

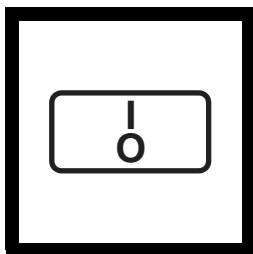
**3.** Apply a thin film of silicone oil. Wipe with a soft cloth to obtain an even film over the entire surface.

*Note: The instrument automatically shuts off after 5.5 minutes if no keystrokes occur. To resume operation, press I/O.*



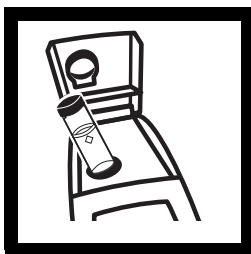
## SECTION 2, continued

---



### 4. Press: **I/O**.

The instrument will turn on. Place the instrument on a flat, sturdy surface. Do not hold the instrument while making measurements.

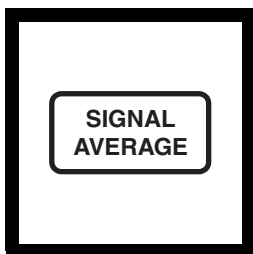


5. Insert the sample cell in the instrument cell compartment so the diamond or orientation mark aligns with the raised orientation mark in front of the cell compartment.

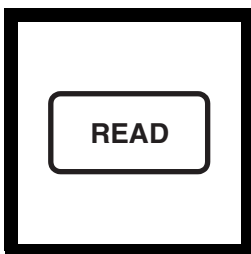
**Close the lid.**



6. Select manual or automatic range selection by pressing the **RANGE** key. The display will show **AUTO RNG** when the instrument is in automatic range selection.



7. Select signal averaging mode by pressing the **SIGNAL AVERAGE** key. The display will show **SIG AVG** when the instrument is using signal averaging. Use signal average mode if the sample causes a noisy signal (display changes constantly).



### 8. Press: **READ**

The display will show **---- NTU**, then the turbidity in NTU. Record the turbidity after the lamp symbol turns off.

*Note: The instrument defaults to the last operating mode selected. If automatic range mode and signal averaging were used on the previous measurements, these options will automatically be selected for subsequent samples.*

## SECTION 2, continued

---

### 2.2.2 Measurement Notes

- Always cap the sample cell to prevent spillage of sample into the instrument.
- When taking a reading, place the instrument on a level, stationary surface. It should not be held in the hand during measurement.
- Always close the sample compartment lid during measurement and storage.
- Always use clean sample cells in good condition. Dirty, scratched, or damaged cells can cause inaccurate readings.
- Do not leave a sample cell in the cell compartment for extended periods of time. This may compress the spring in the cell holder.
- Remove sample cell and batteries from instrument if the instrument is stored for extended time period (more than a month).
- Avoid operating in direct sunlight.
- Make certain cold samples do not “fog” the sample cell.
- Avoid settling of sample prior to measurement.
- Keep sample compartment lid closed to prevent dust and dirt from entering.

### 2.3 Measurement Techniques

Proper measurement techniques are important in minimizing the effects of instrument variation, stray light and air bubbles. Regardless of the instrument used, measurements are more accurate, precise and repeatable if the analyst pays close attention to proper measurement techniques.

Measure samples immediately to prevent temperature changes and settling. Avoid sample dilution when possible. Particles suspended in the original sample may dissolve or otherwise change characteristics when the sample temperature changes or when the sample is diluted, resulting in a non-representative sample measurement.

## SECTION 2, continued

---

### 2.3.1 Cleaning Sample Cells

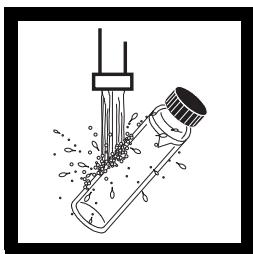
Cells must be extremely clean and free from significant scratches. The glass used to make cells is easily scratched – manufacturing cells free of minor scratches and other imperfections is difficult. However, minor imperfections are effectively masked by applying silicone oil as outlined in *Section 2.3.2*.

Clean the inside and outside of the cells by washing with laboratory detergent. Follow with multiple rinses of distilled or deionized water. Allow cells to air dry. Handle cells only by the top to minimize dirt, scratches and fingerprints in the light path.

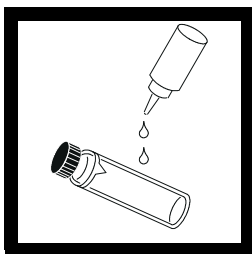
### 2.3.2 Oiling the Sample Cell

Applying a thin coat of silicone oil will mask minor imperfections and scratches which may contribute to turbidity or stray light. Use silicone oil equivalent to Hach Cat. No. 1269-36. This silicone oil has the same refractive index as glass. When applied in a thin, uniform coat, the oil fills in and masks minor scratches and other imperfections in the glass. Apply the oil uniformly by wiping with a soft, lint-free cloth.

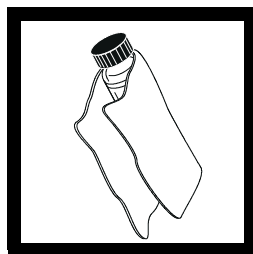
**Avoid application of excess oil.** Applying excess oil may retain dirt and contaminate the instrument's cell compartment.



**1.** Thoroughly clean the sample cell.



**2.** Apply a small bead of silicone oil from the top to the bottom of the cell-- just enough to coat the cell with a thin layer of oil.



**3.** Using a soft, lint-free cloth, spread the oil uniformly, then wipe off the excess so that only a thin coat of oil is left. The cell should appear nearly dry with little or no visible oil.

## SECTION 2, continued

---

*Note: Soft, lint-free cloth (velvet) works well for oiling. Store the oiling cloth with the sample cells and keep it free of dirt. After a few applications of oil, the cloth will contain enough residual oil that simply wiping the cell with the oiled cloth will provide a sufficient oil coat on the sample cell. Periodically, add a small amount of oil to the sample cell surface to replenish the oil in the cloth.*

*Note: Only a thin coat of oil on the sample cells is necessary. Avoid using excessive amounts of oil.*

### 2.3.3 Orienting Sample Cells

*Note: When orienting and matching cells, it may be more efficient to use the continuous reading mode. The instrument performs continuous readings if the **READ** key is pressed and held. As long as the key is held, the lamp remains on and the display is updated every 1.2 seconds. The instrument cannot be used in continuous read mode if the Signal Averaging mode is on.*

Precise measurements for very low turbidity samples require using a single cell for all measurements or optically matching the cells. Using one cell provides the best precision and repeatability. When one cell is used, an orientation mark (other than the factory-placed diamond) can be placed on the cell so it's inserted into the instrument with the same orientation each time.

#### 2.3.3.1 Orienting a single cell

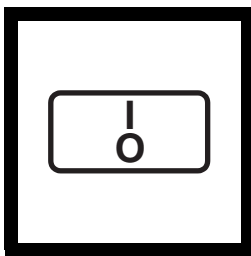
When using a single cell, make an index or orientation mark on the cell as follows:

## SECTION 2, continued

---



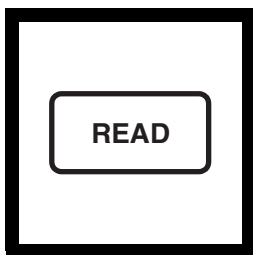
**1.** Fill the clean sample cell to the line with high quality water ( $< 0.5$  NTU). Cap and wipe with lint-free cloth. Apply silicone oil. See *Section 3.6.2.2* on page 40 for more information about high quality water.



**2.** Press: **I/O** to turn the instrument on.



**3.** Insert the sample cell into the sample compartment. Close the cover.



**4.** Press: **READ**

Record the cell's position in the cell compartment and the displayed reading.

*Note: This procedure may be easier if the user holds the **READ** key through the whole process. This allows the lamp to remain on and make continuous readings.*



**5.** Remove the cell, rotate it slightly and reinsert it into the cell compartment. Close the cover, then press **READ**. Record the cell's position and the displayed reading.



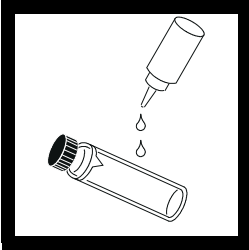
**6.** Repeat *step 5* until the lowest reading is displayed. Place an orientation mark on the cell's marking band near the top of the cell so the cell can be consistently inserted in the position that yields the lowest reading. When using the cell, always place it in the instrument so the orientation mark aligns with the raised mark on the instrument.

## SECTION 2, continued

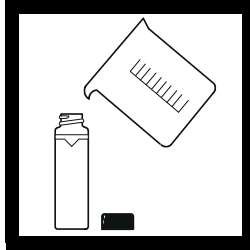
---

### 2.3.4 Matching multiple sample cells

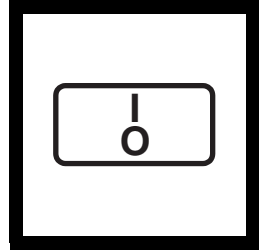
Precise measurements of very low turbidity samples require the cells be optically matched or a single cell be used for all measurements. If more than one cell is used, follow this procedure to match (index) the cells:



**1.** Clean and oil the sample cells as instructed in *Section 2.3.1* on page 23 and *Section 2.3.2* on page 23.



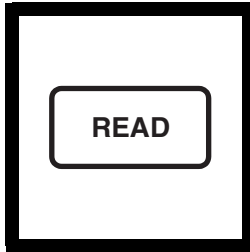
**2.** Fill the clean sample cells to the line with the same sample.



**3.** Press: I/O to turn the instrument on.



**4.** Insert the **first** sample cell into the sample compartment and close the cover.



**5.** Press: **READ**  
Record the cell's position in the cell compartment and the displayed reading. Place an orientation mark on the cell's marking band.

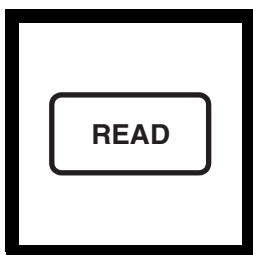


**6.** Insert the **second** sample cell into the cell compartment and close the cover.

*Note: This procedure may be easier if the user holds the **READ** key through the whole process. This allows the lamp to remain on and make continuous readings.*

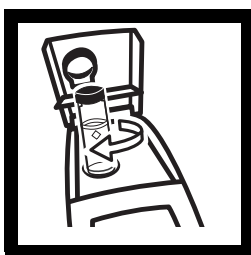
## SECTION 2, continued

---



**7. Press: READ**

Record the cell's position in the cell compartment and the displayed reading.



**8. Remove the cell, rotate it slightly and reinsert into the cell compartment. Close the cover, then press **READ** again. Record the cell's position and the displayed reading.**



**9. Repeat *step 8* until the value displayed for the second cell is within 0.01 NTU (or 1%) of the value obtained for the first cell. Place an orientation mark on the second cell's marking band so it is consistently inserted in this position.**

*Note: Due to variability in glass, it may not be possible to match all cells.*



**10. Repeat *step 6* through *step 9* if matching other sample cells.**

## SECTION 2, continued

---

### 2.3.5 Removing Bubbles (Degassing)

Before measurement, removing air and other trapped gasses from the sample is strongly recommended, even if bubbles are not visible. Four degassing methods are commonly used:

1. applying a partial vacuum
2. adding a surfactant
3. using an ultrasonic bath
4. heating the sample

In some cases, more than one method may be necessary for effective bubble removal. For example, use of both a surfactant and ultrasonic bath may be necessary for some severe conditions. Use care with these techniques. If misused, sample turbidity can be altered.

Removing air bubbles by letting the sample stand for a period of time is not recommended. Particulates that cause turbidity may settle and the sample temperature may change. Both conditions may alter sample turbidity, resulting in measurements not representative of the original turbidity.

#### 2.3.5.1 Application of vacuum

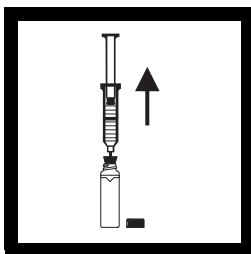
Apply a vacuum with any convenient, clean, oil-free vacuum source. The vacuum lowers the atmospheric pressure, allowing trapped bubbles to escape into the air above the sample. Vacuum works well with non-viscous samples (such as water) that don't contain volatile components. Applying vacuum to viscous, volatile-containing samples (paint resins) may cause the volatile components to come out of solution and aggravate the bubble problem.

To apply a vacuum, use a sample degassing kit equivalent to Cat No. 43975-00 (Degassing Kit) or 43975-10 (Degassing and Filtration Kit). These kits contain a syringe and rubber stopper for vacuum degassing. An electric or hand-operated pump equivalent to Cat No. 14283-00 or 14697-00, respectively, may also be used.



## SECTION 2, continued

---



**1.** Fill a sample cell to the mark with sample. Insert a #2 single-hole rubber stopper and syringe into the cell. If using a pump, insert a piece of glass tubing into the stopper.

**2.** **Slowly** apply the vacuum by carefully pulling the plunger upward, then holding it. If using a hand or electric pump, connect the tubing to the vacuum pump with vacuum hose. Apply vacuum until visible gas bubbles disappear. **Slowly** release the vacuum. Remove the vacuum apparatus and cap the cell.

### 2.3.5.2 Adding a surfactant

Surfactants should be limited to severe problems when other degassing methods are ineffective. Surfactants change the surface tension of the water, which releases trapped gases. Hach recommends a surfactant such as Triton X-100 or the equivalent, Hach Cat No. 14096-37. Put one drop of Triton X-100 in the sample cell before adding sample.

*Note: Any turbidity contributed by surfactant addition is negligible.*

This technique is very effective when the water is super-saturated with air. However, changing the surface tension may accelerate settling of turbidity-causing particles. Mix the sample gently, but thoroughly, and analyze as soon as possible after adding the surfactant. Avoid vigorous mixing as the surfactant may foam. Rinse the sample cells thoroughly between samples to prevent surfactant accumulation.

## SECTION 2, continued

---

### 2.3.5.3 Using an ultrasonic bath

*Note: The time necessary to expel bubbles may vary from a few seconds to a minute or more. To avoid excessive application of ultrasound, a simple procedure can be followed. First, apply ultrasound until all visible bubbles are absent. Then measure the sample turbidity. Apply ultrasound for a short time period and again measure turbidity. Continue for several repetitions, noting the treatment time and turbidity readings. If turbidity begins to increase instead of decrease, the ultrasound waves have probably started to alter the suspended particles. Note the time it takes for this to occur and record it as the maximum time limit for ultrasonic treatment.*

Ultrasonic baths effectively remove gas bubbles from most samples, especially viscous liquids. However, the ultrasonic waves which cause degassing may also alter the characteristics of the particles causing the turbidity. Turbidity depends on the size, shape, composition and refractive index of the suspended particles. Excessive ultrasound application may alter particle size and shape, thus changing sample turbidity. In some cases, ultrasound may aggravate air bubble removal by fracturing the bubbles, making degassing more difficult.

1. Fill a clean sample cell to the line with sample. Leave uncapped.
2. Immerse the cell (1/2 to 2/3 immersed) in an ultrasonic bath and allow it to stand until visible bubbles are expelled.
3. Remove the cell, cap, then thoroughly dry the cell. Apply silicone oil as directed.

### 2.3.5.4 Application of heat

Whenever possible, avoid using heat to degas samples because heat may change the characteristics of the suspended particles and cause volatile components to come out of solution. Gentle heating may be helpful for degassing some very viscous samples when combined with application of vacuum or ultrasound. If heat is necessary, heat the sample only until degassing occurs. The simplest technique is to prepare a warm water bath and partially immerse the filled sample cell. Use the shortest time necessary for expelling visible bubbles. Cool sample to original sample temperature before taking measurements.

## **SECTION 2, continued**

---

### **2.3.6 Measuring Overrange Samples**

Nephelometric turbidity measurement depends on detection of light scattered from particles suspended in the liquid. If the turbidity is very high, a significant amount of light is blocked or absorbed by the particles and only a small amount of light reaches the detector. This results in a negative interference – the measured turbidity is lower than the actual turbidity. This condition is called “going blind”. A multidetector ratioing instrument, such as the Hach 2100P Turbidimeter, minimizes this effect and extends the instrument range. Highly turbid samples may also be diluted, but this should be avoided when possible since it may alter the characteristics of the suspended particles and produce erroneous results.

Light absorbing particles such as activated carbon and highly colored samples may also cause an instrument to “go blind”. Dilution may not correct for these interferences. A ratioing instrument will correct for the presence of light absorbing particles and color.

### **2.3.7 Condensation (fogging)**

Condensation may occur on the outside of the sample cell when measuring a cold sample in a warm, humid environment. Condensation interferes with turbidity measurement, so all moisture must be thoroughly wiped off the sample cell before measurement. If fogging recurs, let the sample warm slightly by standing at room temperature or immersing it in a warm bath for a short period. After warming, mix the sample thoroughly before measurement. Allowing samples to warm can alter sample turbidity, so it is best to avoid warming samples before measurement when possible.

### **2.3.8 Calibration**

Turbidimeters must be properly calibrated with a primary standard. Hach recommends formazin or StablCal Stabilized Formazin for calibration. For U.S. Environmental Protection Agency (USEPA) reporting, calibrate at least as often as required by the appropriate regulatory agencies. The frequency of calibration depends on environmental conditions (humidity, temperature) and use. If necessary, calibrate more frequently.

## SECTION 2, continued

---

Use secondary standards for periodic calibration checks. Please note that Gelex® standards must be assigned values after StablCal Stabilized Formazin calibration or formazin calibration and before use as secondary standards. Gelex standards must be recalibrated (values assigned) each time the instrument is calibrated with StablCal Stabilized Formazin or formazin. See *Section 3.6* on page 37 for detailed information on the use of StablCal Stabilized Formazin, formazin, and Gelex standards.

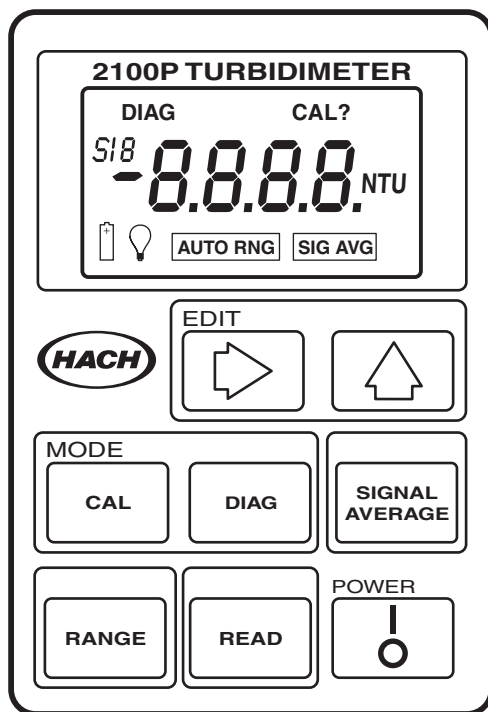
### **2.3.9 Representative Sampling**

A representative sample accurately reflects the true condition of the water source from which the sample was taken. To ensure a representative sample, gently, but thoroughly, mix every sample before aliquots are taken. Do not allow the sample to settle.

When sampling from a tap in a distribution system or treatment plant, allow the water to run for at least five minutes before sampling. When sampling from a stream, reservoir, clarifier, or storage tank, collect at least one liter (1 quart) and thoroughly mix before measurement. If the water source is not uniform, it may be necessary to sample several locations at varying depths and combine the samples into a single, well-mixed composite sample before measurement.






# SECTION 3 OPERATION



## 3.1 Operational Controls and Indicators



Key	Description
	Power key to turn instrument on and off. If no keys are pressed for 5.5 minutes, the instrument turns off automatically.
	Depressed to perform a measurement. To conserve battery power, the lamp turns on only when <b>READ</b> is depressed. A reading is displayed about 12 seconds after the key is depressed. During the delay, a flashing <b>NTU</b> is displayed. After the reading is displayed, the lamp turns off and the reading continues to be displayed. Continuous readings may be done by holding this key if <b>not</b> in the Signal Averaging mode. After the initial delay, the reading is updated every 1.2 seconds.
	Used to perform a calibration or review calibration data. Also terminates a calibration or calibration review and returns to the 2100P measurement mode.

## SECTION 3, continued

Key	Description
	Edits a flashing digit in the calibration mode or sequences through the calibration standards (S0,S1, S2, S3) or diagnostic menu.
	Used to move the editing cursor to the digits being edited in the calibration mode or initiate editing of a standard value.
	Turns the signal averaging function on or off.
	Selects the diagnostic mode.
	Selects Auto Range or Manual Range (one of three manual modes).

Display Icon	Description
<b>DIAG</b>	Turns on after the <b>DIAG</b> is pressed to access the diagnostic mode. A number displayed under the <b>DIAG</b> icon (1-9) indicates which diagnostic function is active. See <i>Section 5.1</i> on page 67 for more information on diagnostic codes.
<b>CAL</b>	Turns on after the <b>CAL</b> key is pressed to access the calibration mode and remains on during the calibration.
<b>CAL?</b>	Appears after calibration if a value entered during calibration is outside an acceptable range. May indicate an operator error or possible instrument malfunction. Flashing <b>CAL?</b> indicates the default calibration coefficients are being used (even after a user-calibration has been done) or that no calibration data is currently stored.
<b>S__</b>	Displayed during calibration. The S is followed by a number to indicate which standard value is currently being edited or displayed. Flashing number is prompting user for measurement of <b>S0</b> , <b>S1</b> , <b>S2</b> or <b>S3</b> to establish a calibration. Steady number identifies which standard's value is being displayed.
	Flashes when the battery voltage drops to 4.4 volts as an indication to change batteries. At <4.0 volts, the instrument automatically shuts off.
	The lamp symbol is constantly on when the lamp is on and flashes after a reading if a marginal light level reaches the transmitted light detector. A flashing icon indicates the sample may be too turbid (not within measurement range) and needs dilution or the lamp needs replacing.
<b>SIGNAL AVERAGE</b>	Indicates the signal averaging mode is on. The icon turns off if signal averaging is not selected.

## SECTION 3, continued

---

Display Icon	Description
<b>AUTO RNG</b>	Indicates instrument is in automatic range mode. The icon turns off when manual range mode is selected.
<b>8888</b>	The 4-digit display is active when the instrument is on (measurements are displayed to three digits). After the <b>READ</b> key is pressed - - - - is displayed during wait periods.
<b>NTU</b>	Identifies the measurement units- Nephelometric Turbidity Units. This icon is active during measurements and in the calibration mode.

### 3.2 Using the Read Key

To preserve battery power and prolong lamp life, the lamp turns on only after the **READ** key is pressed. Pressing the key turns the instrument lamp on; after about 12 seconds, the lamp turns off, but the measurement value continues to be displayed. After the first measurement, a four-second recovery time occurs before another measurement can be started. If **READ** is pressed during the recovery time, the display will begin flashing, but the lamp will not turn on until the full four seconds have passed. If no other key strokes occur within 5.5 minutes, the instrument turns off.

#### 3.2.1 Continuous Reading

The instrument cannot be used in continuous read mode if the Signal Averaging mode is on.

The instrument will perform continuous readings if the **READ** key is pressed and held. As long as the key is held, the lamp remains on and the display is updated every 1.2 seconds.

### 3.3 Using the Signal Averaging Key

The signal averaging mode compensates for reading fluctuations caused by drifting of sample particles through the light path. Signal averaging is turned on or off by pressing the **SIGNAL AVERAGE** key. The **SIG AVG** icon is displayed when signal averaging is on.

Signal averaging measures and averages ten measurements while displaying intermediate results. The initial value is displayed after about 11 seconds and the display is updated every 1.2 seconds until all ten measurements are taken (about 22 seconds). After 22 seconds, the lamp

## SECTION 3, continued

---

turns off, but the final measured turbidity value continues to be displayed until another key is pressed.

When signal averaging is off, the instrument takes three measurements, the microprocessor averages them, then displays the average. If the **READ** key is held during measurement, the initial value is displayed in 12 seconds and is updated every 1.2 seconds as long as the **READ** key is held.

When the instrument is turned on, the instrument defaults to the signal averaging mode which was used during the last measurement.

### 3.4 Using the Range Selection Key

As shipped, the instrument defaults to automatic range mode. The first time the **RANGE** key is pressed, the instrument goes into manual range mode. The second, third, and fourth key strokes put the instrument in the 0.00-9.99, 10 to 99.9 or 100-1000 NTU range, respectively. Another key stroke brings the selection back to automatic range mode. When the automatic range mode is selected, the **AUTO RNG** icon is displayed. Range selection can be done any time except when a measurement or calibration is in progress.

When the instrument is turned on, the instrument defaults to the range mode and measurement range which was used during the last measurement.

### 3.5 Restoring the Default Calibration

To restore and use the default calibration, turn the instrument off. Press and hold **DIAG**, then press and release **I/O**. Release **DIAG** when the software version number disappears from the display. (For models with serial number less than 920300000800, **2100** disappears). This clears any user-entered calibration from memory; the 2100P will use the default calibration for measurement. **CAL?** will appear and continue to flash until a user-entered calibration is successfully completed.

For best results, a user-entered calibration should be done every three months.



## SECTION 3, continued

---

### 3.6 Calibration

Calibration of the 2100P Turbidimeter is based on formazin, the primary standard for turbidity. The instrument's electronic and optical design provide long-term stability and minimize the need for frequent calibration. The two-detector ratioing system compensates for most fluctuations in lamp output. **A formazin recalibration should be performed at least once every three months**, more often if experience indicates the need. When calibration is necessary, use a primary standard such as StablCal™ Stabilized Standards or formazin standards.

**Hach Company only recommends the use of StablCal® Stabilized Formazin or formazin standards for the calibration of Hach turbidimeters. Hach Company cannot guarantee the performance of the turbidimeter if calibrated with co-polymer styrene divinylbenzene beads or other suspensions.**

*Important Note: DO NOT calibrate with Gelex® Secondary Standards. Gelex standards are designed for instrument verification, not calibration.*

#### 3.6.1 StablCal Stabilized Formazin Standards\*

Most consistent results will be achieved with the use of StablCal Stabilized Formazin Standards for calibration. Refer to *Section 3.6.1.2* and *Section 3.6.1.3* for information on preparing the standards for use.

*Note: Hach StablCal Stabilized Formazin in 20-, 100-, and 800-NTU values is packaged in convenient sets for calibration of the 2100P Turbidimeter. The set may be ordered in 500-mL size bottles by specifying Cat. No. 26594-00, in 100-mL size bottles by specifying Cat. No. 26594-10 or in sealed vials by ordering Cat. No. 26594-05. (See OPTIONAL ACCESSORIES AND REAGENTS on page 74.)*

##### 3.6.1.1 Storing and Handling StablCal Stabilized Standards

For optimum results when using StablCal Stabilized Standards, adhere to the following recommendations:

---

\* StablCal Stabilized Formazin is cited as a primary standard in Hach Method 8195, an acceptable version of USEPA Method 180.1.

## SECTION 3, continued

---

- Do not transfer the standard to another container for storage.
- Do not return standard from the sample cell back into the its original container. Standard contamination will result.
- Store standards between 0 and 25 °C.
- For long-term storage, refrigeration at 5 °C is recommended. Do not store above 25 °C.
- Allow the standard to acclimate to ambient instrument conditions before use (not to exceed 40 °C).
- Store away from direct sunlight. Store vials in their respective kit or shipping box with the cover in place.

### 3.6.1.2 Preparing Bulk StablCal Stabilized Standards

Bulk standards that have been sitting undisturbed for longer than a month must be shaken to break the condensed suspension into its original particle size. Start at *step 1* for these standards. If the standards are used on at least a weekly interval, start at *step 3*.

*Important Note: These instructions do not apply to <0.1-NTU\* StablCal Standards; <0.1NTU StablCal Standards should not be shaken or inverted.*

1. Shake the standard vigorously for 2-3 minutes to resuspend any particles.
2. Allow the standard to stand undisturbed for 5 minutes.
3. Gently invert the bottle of StablCal 5 to 7 times.
4. Prepare the sample cell for measurement using traditional preparation techniques. This usually consists of oiling the sample cell (see *Section 2.3.2* on page 23) and marking the cell to maintain the same orientation in the sample cell compartment (see *Section 2.3.3* on page 24). This step will eliminate any optical variations in the sample cell.

---

\* Used in place of the dilution water standard when performing a calibration.

## SECTION 3, continued

---

5. Rinse the sample cell at least one time with the standard and discard the rinse.
6. Immediately fill the sample cell with the standard. Cap the sample cell and let it stand for one minute. The standard is now ready for use in the calibration procedure, *Section 3.6.3*.

### 3.6.1.3 Preparing StablCal Stabilized Standards in Sealed Vials

Sealed vials that have been sitting undisturbed for longer than a month must be shaken to break the condensed suspension into its original particle size. Start at *step 1* for these standards. If the standards are used on at least a weekly interval, start at *step 3*

*Important Note: These instructions do not apply to <0.1-NTU\* StablCal Standards; <0.1NTU StablCal Standards should not be shaken or inverted.*

1. Shake the standard vigorously for 2-3 minutes to resuspend any particles.
2. Allow the standard to stand undisturbed for 5 minutes.
3. Gently invert the vial of StablCal 5 to 7 times.
4. Prepare the vial for measurement using traditional preparation techniques. This usually consists of oiling the vial (see *Section 2.3.2* on page 23) and marking the vial to maintain the same orientation in the sample cell compartment (see *Section 2.3.3* on page 24). This step will eliminate any optical variations in the sample vial.
5. Let the vial stand for one minute. The standard is now ready for use in the calibration procedure, *Section 3.6.3*.

## SECTION 3, continued

---

### 3.6.2 Formazin Primary Standards

Perform the procedure in *Section 3.6.2.1* to prepare a 4000-NTU standard. Alternately, order a 4000-NTU stock solution from Hach by specifying Cat. 2461-49. Prepare the dilutions from the 4000-NTU stock solution by following the instructions in *Section 3.6.2.4*.

#### 3.6.2.1 Preparing Formazin Stock Solution

Dilute formazin standard solutions from a 4000 NTU stock solution equivalent to Hach Cat. No. 2461-49. The prepared stock solution is stable for up to one year when properly prepared. An alternative to purchasing the 4000 NTU stock solution is preparing a stock solution as follows:

1. Dissolve 5.000 grams of reagent grade hydrazine sulfate ( $N_2H_4 \cdot H_2SO_4$ ) in 400 mL of distilled water.
2. Dissolve 50.000 grams of pure hexamethylenetetramine in 400 mL of distilled water.
3. Pour the two solutions into a 1000-mL volumetric flask and dilute to the mark with distilled water.
4. Let the solution stand for 48 hours at 25 °C (77 °F) to develop the 4000-NTU stock suspension. The standing temperature is critical for correct formation of formazin polymers.
5. Mix the 4000 NTU suspension for at least ten minutes before use. Then it can be diluted with distilled or demineralized water to achieve a solution of the desired NTU value.

Instead of diluting a formazin stock solution, StablCal Stabilized Formazin Standards may be used. Order the StablCal Calibration Set for the 2100P Turbidimeter, Cat.No. 26594-00 (500-mL bottles), Cat. No. 26594-10 (100 mL bottles), or Cat. No. 26594-05 (sealed vials). (See *OPTIONAL ACCESSORIES AND REAGENTS* on page 74.)

#### 3.6.2.2 Correcting for Turbidity of Dilution Water

The 2100P Turbidimeter automatically compensates for turbidity contributed by dilution water when calculating the true value of the lowest formazin standard. Use high quality distilled or deionized water less than 0.5 NTU. The instrument will display E 1 after calibration if

## SECTION 3, continued

---

the dilution water turbidity is greater than 0.5 NTU. In this case, prepare the water as directed below.

The value of the dilution water can be arbitrarily forced to zero (see calibration procedure). This is not recommended for most applications and, if done, should be done only if the dilution water turbidity is less than 0.2 NTU.

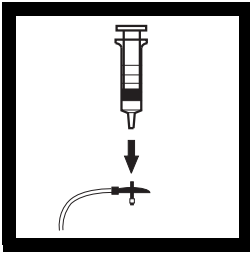
### 3.6.2.3 Preparing Dilution Water

*Note: Use the same dilution water for all dilutions and the sample blank.*

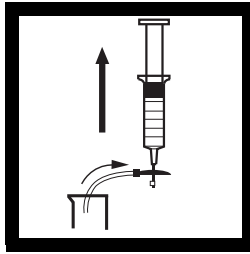
Collect at least 1000 mL of high quality dilution water (distilled or deionized water). The 2100P Turbidimeter, as received from the factory, is precalibrated and may be used to check the dilution water turbidity. If the turbidity is greater than 0.5 NTU, filter the water with the Sample Filtration and Degassing Kit (Cat. No. 43975-10) or equivalent. When measuring low range turbidity, clean all glassware with 1:1 hydrochloric acid and rinse several times with dilution water. If the glassware is not used immediately, use stoppers to prevent contamination from small particles.

## SECTION 3, continued

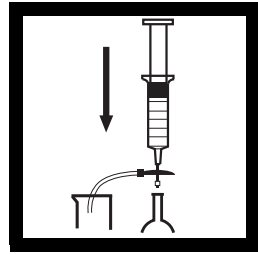
---



**1.** Attach the syringe to the 3-way valve by gently twisting the square end into the syringe tip. Attach the connector, tubing and a 0.2 micron filter (clear part faces syringe) as shown. Be sure the connections are tight.



**2.** Fill a beaker or container with the water to be filtered. Insert the tubing into the container. Slowly draw the water into the syringe by pulling up on the syringe plunger.



**3.** Draw about 50 mL of sample into the syringe. Slowly push on the plunger to force the water through the filter and into a graduated cylinder or volumetric flask. Repeat Steps 2 and 3 until the desired amount of water is obtained.

*Note: As the filter clogs, it gets more difficult to push water through it. At this point, discard the filter and attach a new filter. Replacement filters are available in packages of 10 (Cat. No. 23238-10).*

---

### 3.6.2.4 Preparing Formazin Dilutions (Factory recommended)

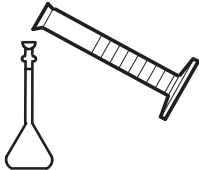
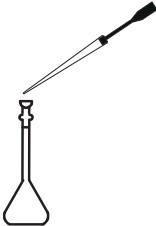

Hach Company recommends using 20, 100, and 800 NTU formazin standards for calibrating the 2100P Turbidimeter. Dilutions with other NTU values can be prepared and used (see *Section 3.6.3.1* on page 48). If problems occur when using alternate solutions, use the dilutions specified here.

Prepare all formazin dilutions immediately before use and discard after calibration. The 4000 NTU solution is stable for up to a year, but dilutions deteriorate more rapidly. Use the same high quality water (turbidity <0.5 NTU) for the dilutions and the blank.

## SECTION 3, continued

### Preparing the 20, 100 and 800 NTU standards

Table 1 Formazin Standard Preparation

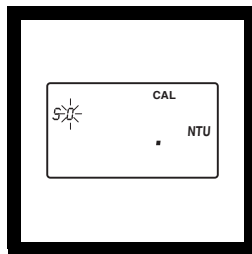
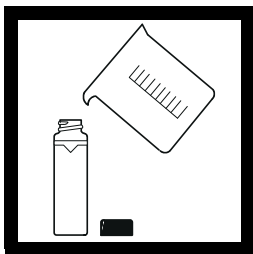
	Step 1	Step 2	Step 3
Standards			
20 NTU	Add 100 mL of dilution water to a clean <b>200-mL</b> class A volumetric flask.	With a TenSette* pipet, add 1.00 mL of well-mixed 4000 NTU Formazin stock solution to the 200-mL flask.	Dilute to the mark with dilution water. Stopper and mix.
100 NTU	Add 100 mL of dilution water to a clean <b>200-mL</b> class A volumetric flask.	With a TenSette pipet, add 5.00 mL of well-mixed 4000 NTU Formazin stock solution to the 200-mL flask.	Dilute to the mark with dilution water. Stopper and mix.
800 NTU	Add 50 mL of dilution water to a clean <b>100-mL</b> class A volumetric flask.	With a TenSette pipet, add 20.00 mL of well-mixed 4000 NTU Formazin stock solution to the 100-mL flask.	Dilute to the mark with dilution water. Stopper and mix.

\* A class A volumetric pipet may be used in place of a TenSette Pipet.

## SECTION 3, continued

### 3.6.3 Calibrating the Turbidimeter

*Note: For best accuracy use the same sample cell or four matched sample cells for all measurements during calibration. Always insert the cell so the orientation mark placed on the cell during the matching procedure is correctly aligned. (See Section 2.3.4 on page 26 for matching sample cells).*



**1.** Rinse a clean sample cell with dilution water several times. Then fill the cell to the line (about 15 mL) with dilution water or use StablCal <0.1 NTU standard.

*Note: The same dilution water used for preparing the standards must be used in this step.*

**2.** Insert the sample cell in the cell compartment by aligning the orientation mark on the cell with the mark on the front of the cell compartment. Close the lid. Press I/O.

*Note: Choose signal average mode option (on or off) before pressing CAL – the SIGNAL AVERAGE key is not functional in calibration mode.*

**3.** Press: CAL

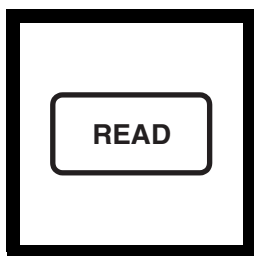
The CAL and S0 icons will be displayed (the 0 will flash). The 4-digit display will show the value of the S0 standard for the previous calibration. If the blank value was forced to 0.0, the display will be blank (as shown). Press → to get a numerical display.

**Hach Company only recommends the use of StablCal® Stabilized Formazin or formazin standards for the calibration of Hach turbidimeters. Hach Company cannot guarantee the performance of the turbidimeter if calibrated with co-polymer styrene divinylbenzene beads or other suspensions. DO NOT calibrate with Gelex® Secondary Standards.**



## SECTION 3, continued

---



### 4. Press: **READ**

The instrument will count from 60 to 0, (67 to 0 if signal average is on), read the blank and use it to calculate a correction factor for the 20 NTU standard measurement.

If the dilution water is  $\geq 0.5$  NTU, E 1 will appear when the calibration is calculated (See Section 3.6.2.3 on page 41 for more dilution water information).

The display will automatically increment to the next standard. Remove the sample cell from the cell compartment.

*Note: The turbidity of the dilution water can be "forced" to zero by pressing → rather than reading the dilution water. The display will show **S0** NTU and the ↑ key must be pressed to continue with the next standard.*

5. The display will show the **S1** (with the 1 flashing) and **20** NTU or the value of the S1 standard for the previous calibration. If the value is incorrect, edit the value by pressing the → key until the number that needs editing flashes. Use the ↑ key to scroll to the correct number. After editing, fill a clean sample cell to the line with **well mixed** 20 NTU StablCal Standard or 20 NTU formazin standard. Insert the sample cell into the cell compartment by aligning the orientation mark on the cell with the mark on the front of the cell compartment. Close the lid.

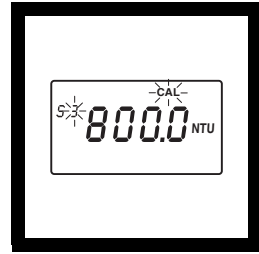
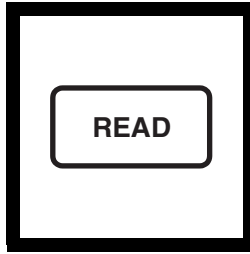
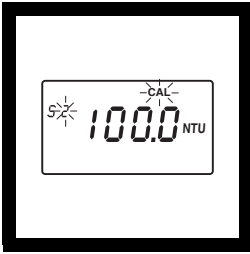
### 6. Press: **READ**

The instrument will count from 60 to 0 (67 to 0 if signal average is on), measure the turbidity and store the value. The display will automatically increment to the next standard. Remove the sample cell from the cell compartment.

*Note: For potable water applications with low turbidity values the instrument calibration may be stopped after the 20 NTU StablCal Standard has been read. Press **CAL** after reading the 20 NTU standard. The instrument calibration is now complete for the range of 0-20 NTU only. The instrument will continue to read turbidity values above 20 NTU. These values were not updated during the 0-20 NTU calibration.*

## SECTION 3, continued

---



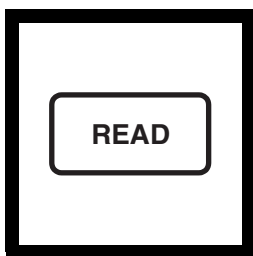
7. The display will show the **S2** (with the 2 flashing) and **100 NTU** or the value of the S2 standard for the previous calibration. If the value is incorrect, edit the value by pressing the → key until the number that needs editing flashes. Use the ↑ key to scroll to the correct number. After editing, fill a clean sample cell to the line with **well mixed** 100 NTU StablCal Standard or 100 NTU formazin standard. Insert the sample cell into the cell compartment by aligning the orientation mark on the cell with the mark on the front of the cell compartment. Close the lid.

8. Press: **READ**  
The instrument will count from 60 to 0 (67 to 0 if signal average is on), measure the turbidity and store the value. Then, the display will automatically increment to the next standard. Remove the sample cell from the cell compartment.

9. The display will show the **S3** (with the 3 flashing) and **800 NTU** or the value of the S3 standard for the previous calibration. If the value is incorrect, edit the value by pressing the → key until the number that needs editing flashes. Use the ↑ key to scroll to the correct number. After editing, fill a clean sample cell to the line with **well mixed** 800 NTU StablCal Standard or 800 NTU formazin standard. Insert the sample cell into the cell compartment by aligning the orientation mark on the cell with the mark on the front of the cell compartment. Close the lid.

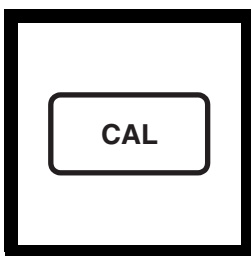
## SECTION 3, continued

---



### 10. Press: **READ**

The instrument will count from 60 to 0 (67 to 0 if signal average is on), measure the turbidity and store the value. Then the display will increment back to the S0 display. Remove the sample cell from the cell compartment.



11. Press: **CAL** to accept the calibration. The instrument will return to measurement mode automatically.

*Note: Pressing **CAL** completes the calculation of the calibration coefficients. If calibration errors occurred during calibration, error messages will appear after **CAL** is pressed. If **E 1** or **E 2** appear, check the standard preparation and review the calibration; repeat the calibration if necessary. If **CAL?** appears, an error may have occurred during calibration. If **CAL?** is flashing, the instrument is using the default calibration.*

## SECTION 3, continued

---

### NOTES

- If the **I/O** key is pressed during calibration, the new calibration data is lost and the old calibration will be used for measurements. Once in calibration mode, only the **READ**, **I/O**, **↑**, and **→** keys function. Signal averaging and range mode must be selected before entering the calibration mode.
- If **E 1** or **E 2** are displayed, an error occurred during calibration. Check the standard preparation and review the calibration; repeat the calibration if necessary. Press **DIAG** to cancel the error message (**E 1** or **E 2**). To continue without repeating the calibration, press **I/O** twice to restore the previous calibration. If **CAL?** is displayed, an error may have occurred during calibration. The previous calibration may not be restored. Either recalibrate or use the calibration as is.
- To review a calibration, press **CAL** and then **↑** to view the calibration standard values. As long as **READ** is never pressed and **CAL** is not flashing, the calibration will not be updated. Press **CAL** again to return to the measurement mode.

#### 3.6.3.1 Preparing User-selected Formazin Dilutions

The formazin solutions should span the entire range of the instrument. Hach recommends preparing three standards:

1. 10 to 30 NTU
2. 90 to 110 NTU
3. 700 to 900 NTU

**The standards must have a difference of at least 60 NTU.**

In addition, a blank made from the dilution water should be prepared.

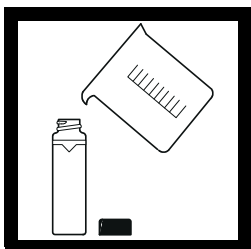
Prepare the formazin standard solutions from the well mixed 4000 NTU stock solution as specified in *Section 3.6.2.4* on page 42 and dilution water as specified in *Section 3.6.2.2* and *Section 3.6.2.3* on page 41. Make the standards **immediately** before use and discard them after calibration is done.

## SECTION 3, continued

---

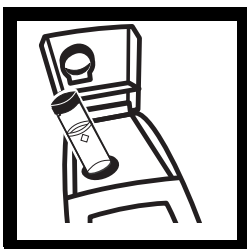
### 3.6.3.2 Calibrating with User-selected Standards

*Note: For best accuracy use the same sample cell or four matched sample cells for all measurements during calibration. Always insert the sample cell with the same orientation.*



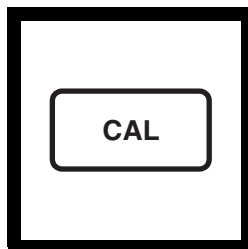
**1.** Fill a clean sample cell to the line (about 15 mL) with dilution water.

*Note: The same dilution water used for preparing the standards must be used in this step.*



**2.** Insert the sample cell into the cell compartment and close the lid. Press I/O.

*Note: Choose signal average mode option (on or off) before pressing CAL – the SIGNAL AVERAGE key is not functional in calibration mode.*

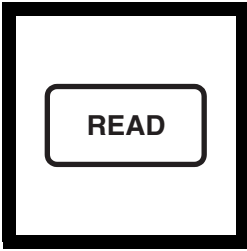


**3.** Press: CAL.

The CAL and S0 icons will appear (the 0 will flash). The 4-digit display will show the value of the S0 standard for the previous calibration.

## SECTION 3, continued

---



**4.** Press: **READ**.

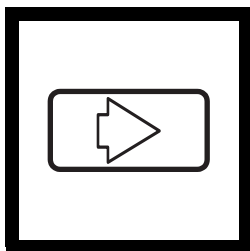
The instrument will count from 60 to 0 (67 to 0 if signal average is on), measure the blank and use it to calculate a correction factor for the lowest standard. If the dilution water is  $\geq 0.5$  NTU, **E 1** will appear (see *Section 3.6.2.3* on page 41 for more dilution water information). The display will automatically increment to the next standard. Remove the sample cell from the cell compartment.

**5.** Thoroughly mix the 10 to 30 NTU range standard, then fill a clean sample cell to the line with the standard. Insert the sample cell into the cell compartment

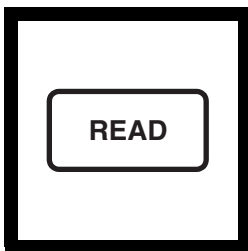
**6.** The display will show the **S1** icon (with the **1** flashing) and **20 NTU** or the value of the S1 standard for the previous calibration.

## SECTION 3, continued

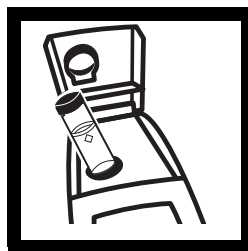
---



**7.** Edit the standard concentration by pressing →. The **1** will stop flashing and the left digit in the display will flash. Press ↑ to scroll the digit up to the appropriate number. Press → again to move the cursor to the next digit and edit it in the same manner.



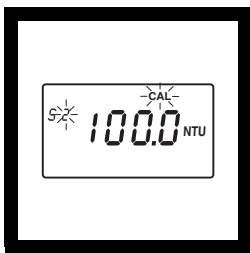
**8.** When all the digits show the appropriate value, press **READ**. The instrument will count from 60 to 0 (67 to 0 if signal average is on), measure the turbidity and store the value. The display will automatically increment to the next standard. Remove the sample cell from the cell compartment.



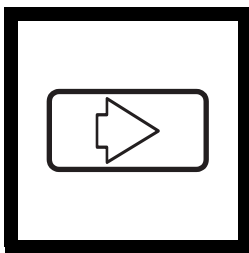
**9.** Thoroughly mix the 90 to 110 NTU standard, then fill a clean sample cell to the line with the standard. Insert the cell into the cell compartment.

## SECTION 3, continued

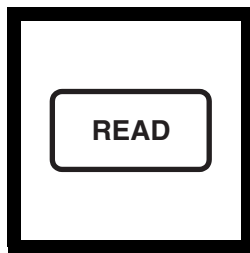
---



**10.** The display will show the **S2** icon (with the **2** flashing) and **100 NTU** or the value of the S2 standard for the previous calibration.



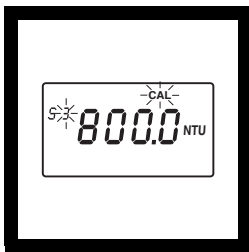
**11.** Edit the standard concentration by pressing →. The **2** will stop flashing and the left digit in the display will flash. Press ↑ to scroll the digit up to the appropriate number. Press → again to move the cursor to the next digit and edit it in the same manner.



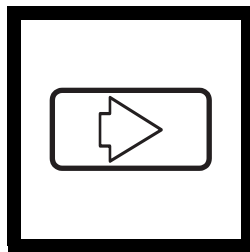
**12.** When all the digits show the appropriate value, press **READ**. The instrument will count from 60 to 0 (67 to 0 if signal average is on), measure the turbidity and store the value. Remove the sample cell from the cell compartment.



**13.** Thoroughly mix the 700 to 900 NTU standard, then fill a clean sample cell to the line with the standard. Insert the cell into the cell compartment.



**14.** The display will show the **S3** icon (with the **3** flashing) and **800 NTU** or the value of the S3 standard for the previous

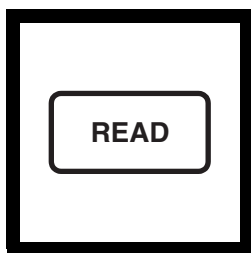


**15.** Edit the standard concentration by pressing →. The **3** will stop flashing and the left digit in the display will flash. Press ↑ to scroll the digit up to the appropriate number. Press → again to move the cursor to the next digit and edit it in the same manner.

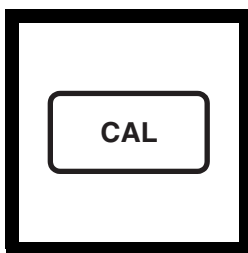


## SECTION 3, continued

---



**16.** When all the digits show the appropriate value, press **READ**. The instrument will count from 60 to 0 (67 to 0 if signal average is on), measure the turbidity and store the value. The instrument will increment back to **S0**. Remove the sample cell from the cell compartment.



**17.** Press: **CAL**.

The instrument will store the new calibration data and return the instrument to the measurement mode. It will use the new calibration to calculate turbidity for subsequent measurements.

*Note: Pressing **CAL** completes the calculation of the calibration coefficients. If calibration errors occurred during calibration, error messages will appear after **CAL** is pressed. If **E 1** or **E 2** appear, check the standard preparation and review the calibration; repeat the calibration if necessary. If **CAL?** appears, an error may have occurred during calibration. If **CAL?** is flashing, the instrument is using the default calibration.*

## SECTION 3, continued

---

### NOTES

- If the **I/O** key is pressed during calibration, the new calibration data is lost and the old calibration will be used for measurements. Once in calibration mode, only the **READ**, **I/O**, **↑**, and **→** keys function. Signal averaging and range mode must be selected before entering the calibration mode.
- If **E 1** or **E 2** are displayed, an error occurred during calibration. Check the standard preparation and review the calibration; repeat the calibration if necessary. If the error messages recur, calibrate using the factory specified standards, *Section 3.6.2.4* on page 42 and *Section 3.6.3* on page 44. Press **DIAG** to cancel the error message (**E 1** or **E 2**). To continue without repeating the calibration, press **I/O** twice to restore the previous calibration. If **CAL?** is displayed, an error may have occurred during calibration. The previous calibration may not be restored. Either recalibrate or use the calibration as is.
- To review a calibration, press **CAL** and then only **↑** to view the calibration standard values. As long as **READ** is never pressed and **CAL** isn't flashing, the calibration will not be updated. Press **CAL** again to return to the measurement mode.

### 3.6.4 Using Gelex® Secondary Turbidity Standards

*Note:* Store Gelex standards at room temperature. Do not allow to freeze or exceed 50 °C.

Gelex Secondary Standards (included with 4650000 only) are particulate suspensions similar to formazin primary standards in light scattering characteristics. NTU values on the Gelex standards indicate the range for which they should be used. Due to minor variations in glass and individual instrument optical systems, the true value of the Gelex standards must be determined against formazin in the same instrument they will be used with for later calibration checks.

## SECTION 3, continued

---

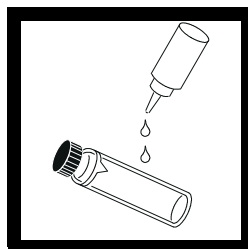
### 3.6.4.1 Assigning Values to Gelex Standards



**1.** Calibrate the instrument with formazin.



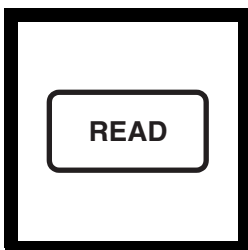
**2.** Select automatic range mode using the **RANGE** key.



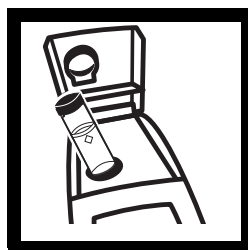
**3.** Thoroughly clean the outside of the Gelex vials and apply a thin coating of silicone oil.



**4.** Place the 0-10 NTU Gelex standard in the cell compartment so the diamond on the vial aligns with the orientation mark on the instrument. Close the sample lid.



**5.** Press: **READ**.  
Record the displayed value, remove the vial from the instrument and mark the value on the band near the top of the vial.



**6.** Repeat *step 3* through *step 5* for the other Gelex standards, being careful to orient the cells properly.

*Note: Correct cell orientation is essential to obtain accurate Gelex values. Always orient the cell so the diamond mark aligns with the orientation mark on the instrument.*

## SECTION 3, continued

---

**Re-assign  
with every  
formazin  
calibration**

7. Re-assign values to the Gelex standards each time the instrument is calibrated with formazin.

### **3.6.4.2 Routine Calibration Check With Gelex Standards**

The 2100P Turbidimeter does not require standardization before every measurement as some turbidimeters do. Periodically, as experience dictates, check the instrument calibration using the appropriate Gelex Secondary Standard. Be sure the Gelex standards are aligned correctly when inserting them (diamond aligns with orientation mark). If the reading is not within 5% of the previously established value, recalibrate the instrument with StablCal Stabilized Formazin Primary Standard or formazin primary standard (*Section 3.6.3 on page 44*).

***Important Note: DO NOT calibrate with Gelex® Secondary Standards. Gelex standards are designed for instrument verification, not calibration.***



## MAINTENANCE

**Some of the following manual sections contain information in the form of warnings, cautions and notes that require special attention. Read and follow these instructions carefully to avoid personal injury and damage to the instrument. Only personnel qualified to do so, should conduct the maintenance tasks described in this portion of the manual.**

**Certains des chapitres suivants de ce mode d'emploi contiennent des informations sous la forme d'avertissements, messages de prudence et notes qui demandent une attention particulière. Lire et suivre ces instructions attentivement pour éviter les risques de blessures des personnes et de détérioration de l'appareil. Les tâches d'entretien décrites dans cette partie du mode d'emploi doivent être seulement effectuées par le personnel qualifié pour le faire.**

**Algunos de los capítulos del manual que presentamos contienen muy importante información en forma de alertas, notas y precauciones a tomar. Lea y siga cuidadosamente estas instrucciones a fin de evitar accidentes personales y daños al instrumento. Las tareas de mantenimiento descritas en la presente sección deberán ser efectuadas únicamente por personas debidamente cualificadas.**

**Einige der folgenden Abschnitte dieses Handbuchs enthalten Informationen in Form von Warnungen, Vorsichtsmaßnahmen oder Anmerkungen, die besonders beachtet werden müssen. Lesen und befolgen Sie diese Instruktionen aufmerksam, um Verletzungen von Personen oder Schäden am Gerät zu vyyermeiden. In diesem Abschnitt beschriebene Wartungsaufgaben dürfen nur von qualifiziertem Personal durchgeführt werden.**

**Algumas das seguintes secções do manual contêm informações em forma de advertências, precauções e notas que requerem especial atenção. Leia e siga atentamente as presentes instruções para evitar ferimentos pessoais e não danificar o instrumento. As tarefas de manutenção descritas nesta parte do manual só poderão ser executadas por pessoal qualificado.**



## SECTION 4 MAINTENANCE

---

### 4.1 Cleaning

Keep the turbidimeter and accessories as clean as possible and store the instrument in the carrying case when not in use. Avoid prolonged exposure to sunlight and ultraviolet light. Wipe spills up promptly. Wash sample cells with non-abrasive laboratory detergent, rinse with distilled or demineralized water, and air dry. Avoid scratching the cells and wipe all moisture and fingerprints off the cells before inserting them into the instrument. Failure to do so can give inaccurate readings. See *Section 2.3.1* on page 23 for more information about sample cell care.

### 4.2 Battery Replacement

AA alkaline cells typically last for about 300 tests with the signal averaging mode off, about 180 tests if signal averaging is used. The “battery” icon flashes when battery replacement is needed. Refer to *Section 1.4.2* on page 16 for battery installation instructions. If the batteries are changed within 30 seconds, the instrument retains the latest range and signal average selections. If it takes more than 30 seconds, the instrument uses the default settings.

If, after changing batteries, the instrument will not turn off or on and the batteries are good, remove the batteries and reinstall them. If the instrument still won't function, contact Hach Service or the nearest authorized dealer.

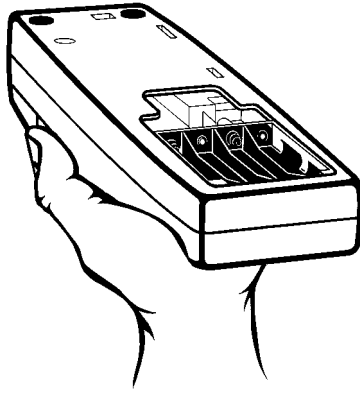
### 4.3 Lamp Replacement

The procedure below explains lamp installation and electrical connections. Use a small screwdriver to remove and install the lamp leads in the terminal block. The instrument requires calibration after lamp replacement.

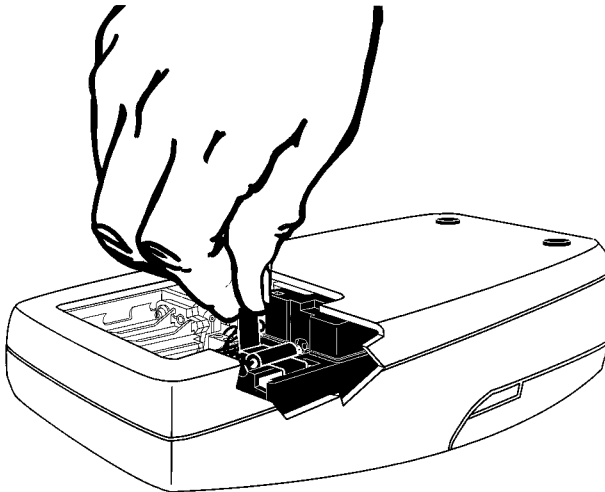
## SECTION 4, continued

---

1. Orient the instrument so it is upside down and the top faces away from you. Remove the battery cover and at least one battery.



2. Remove the lamp assembly by grasping the tab on the left side of the assembly. Firmly, but gently, slide the assembly towards the rear of the instrument.

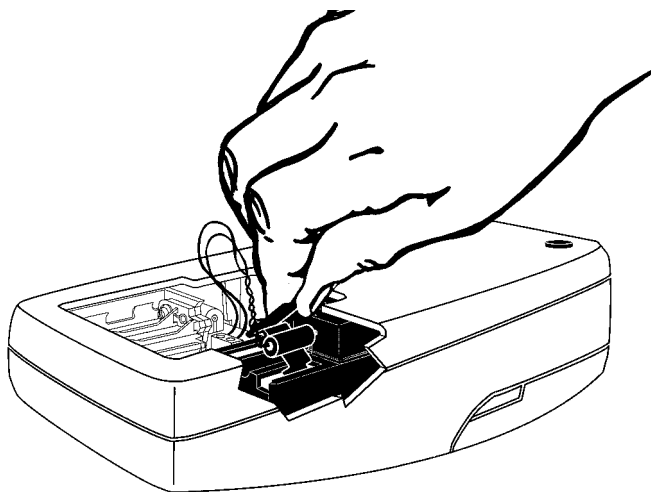




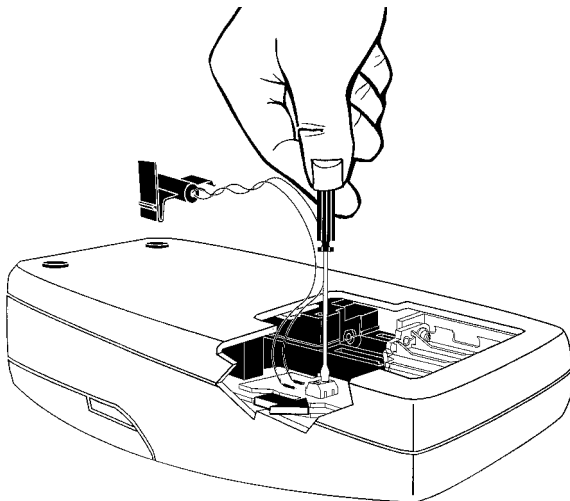
## SECTION 4, continued

---

3. Rotate the tab towards the nearest outside edge. The assembly should release and slip out easily.



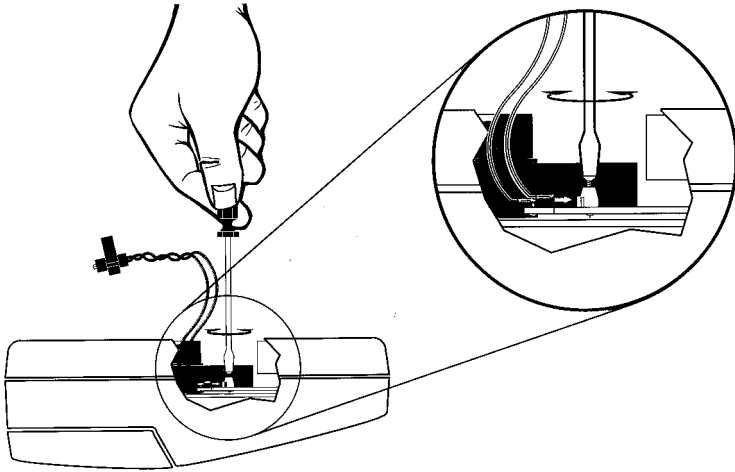
4. Back the terminal block screws **partially** out (1 to 2 turns) and remove the old lamp leads.



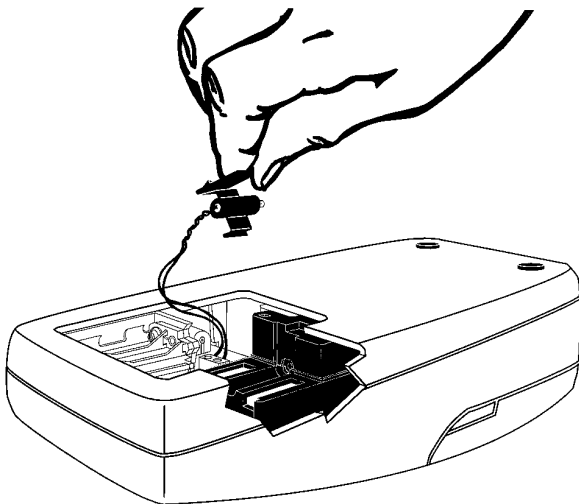
## SECTION 4, continued

---

5. Gently bend the wires of the new lamp assembly into an “L” shape so they fit easily into the housing. Insert the leads into the terminal screws and tighten with clockwise turns. Gently tug on the wires to make sure they are connected to the terminal block.



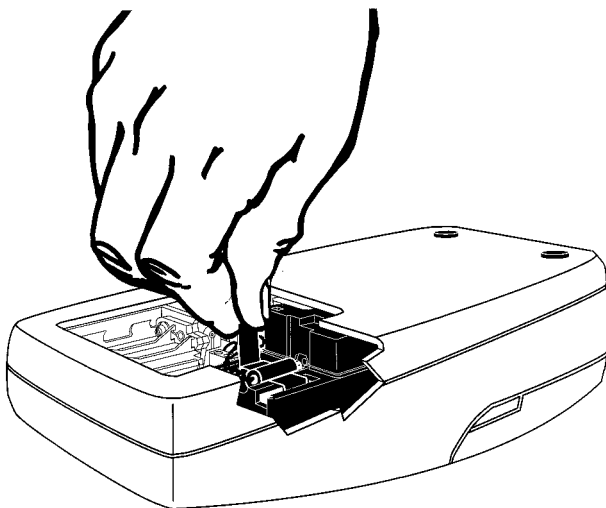
6. Hold the new lamp assembly by the tab with the lamp facing the top (keyboard) of the instrument. Slide the small catch on the other side of the assembly into the black plastic slot (towards the nearest edge of the instrument).



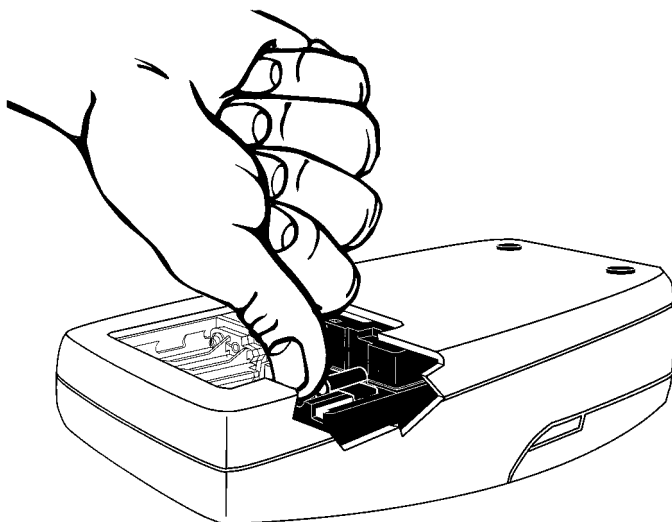
## SECTION 4, continued

---

7. Snap the U-shaped bottom of the tab into the slot on the left side of the black plastic that holds the lamp assembly.



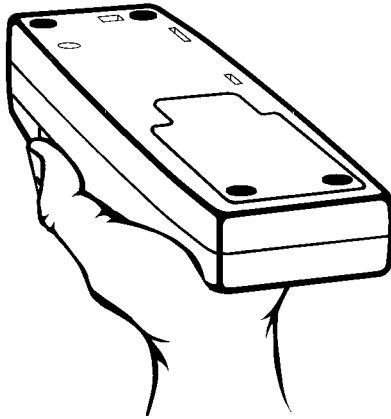
8. With your thumb, firmly slide the assembly forward until it stops. Again, push firmly against the tab to make sure the lamp is seated correctly.



## SECTION 4, continued

---

9. Replace the battery(s) and battery cover.



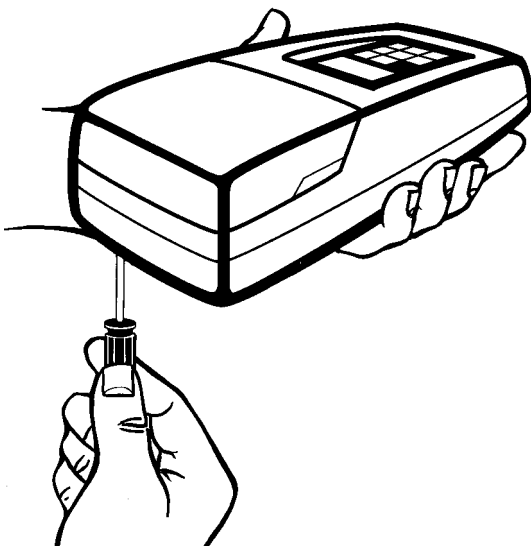
10. Insert the 800 NTU formazin standard into the sample cell. Press and hold **READ**. Then press **I/O**. Release the **READ** key after the software version number disappears from the display (for models with serial numbers less than 920300000800, **2100** disappears).



## SECTION 4, continued

---

11. Adjust the scattered light amplifier output by inserting a small flat-bladed screwdriver into the trimpot hole (located on bottom). Adjust the display to read  $2.5 \pm 0.3$  volts (2.0 volts for models that display **2100** when turned on).



12. Press I/O to exit gain adjust mode.
13. Perform a formazin calibration according to *Section 3.6.3* on page 44 or *Section 3.6.3.1* on page 48.



# SECTION 5 TROUBLESHOOTING

---

## 5.1 Using the Diagnostic Functions Key

Enter the diagnostic mode by pressing the **DIAG** key. Exit this mode at any time by pressing the key again. The diagnostic mode allows access to information about instrument function which may be useful for servicing and troubleshooting.

### 5.1.1 Basic Diagnostic Codes

The diagnostic codes are:

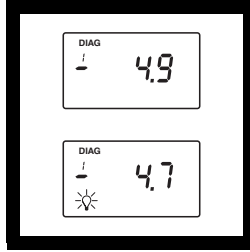
Code	Description
1	Checks the battery voltage with the lamp on, then with the lamp off. This is a dual diagnostic code.
2	Displays calibration coefficient $a_0$
3	Displays calibration coefficient $a_1$
4	Displays calibration coefficient $b_0$
5	Displays calibration coefficient $b_1$
6	Displays the lamp voltage (about 3 volts)
7	Displays the dark voltage of the transmitted light detector amplifier with the lamp off and the detector amplifier voltage with the lamp on.
8	Displays the high gain dark voltage of the 90° detector amplifier with the lamp off and the detector amplifier voltage with the lamp on.*
9	Displays the low gain dark voltage of the 90° detector amplifier with the lamp off and the detector amplifier voltage with the lamp on.

\* Samples with turbidity >10 NTU may display - - - for the lamp-on amplifier voltage.

### 5.2 The Diagnostic Procedure

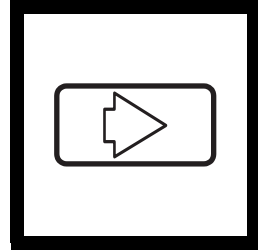


**1.** Fill a clean sample cell to the line with clear water, cap the cell and place it in the cell compartment. Press the **READ** key and wait until the reading is finished.



**2.** Press: **DIAG**

The **DIAG** icon will turn on and **1** will be displayed below the icon. The instrument will measure the battery voltage with the lamp off and display the result in volts (V). Then the lamp icon will turn on and the instrument will measure the voltage with the lamp on. The value is briefly displayed before defaulting to the lamp-off reading. To repeat the measurement, press **READ**.

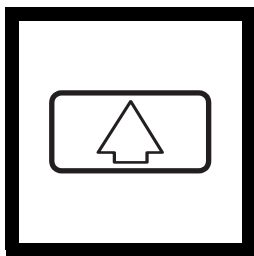


**3.** To continuously display the lamp-on voltage, press →. The lamp icon will flash. Press → to turn the lamp icon off (the lamp is not on during this display).



## SECTION 5, continued

---



4. Press the ↑ key to scroll through the other diagnostics. Each press of the key increments the digit in the small numerical display below the **DIAG** icon and the result of the diagnostic measurement is then displayed. Each press of the **READ** key updates the value. For measurements made with the lamp off and again with the lamp on, the measurement with the lamp off is displayed when the diagnostic is entered. To see the second measurement with the lamp on, press the → key (only works with diagnostic codes 1, 7, 8, & 9). The lamp icon will flash and the lamp-on measurement will be displayed in volts. Press → to turn the lamp icon off.

*Note: DIAG 8 will display --- for the lamp-on voltage if a of >10 NTU is placed in the cell compartment.*

### 5.3 Other Instrument Diagnostics

#### 5.3.1 Display Test

Pressing and holding the I/O key turns on all the display icons and elements so you can determine if all the elements and icons are functioning. The display test sequence will cycle as long as the key is held down.

### 5.4 Error Messages

Error messages indicate sample interferences and/or instrument malfunction.

#### 5.4.1 Flashing Numeric Display

If the highest value in the range selected is flashing in the display, the sample is too turbid (or overrange) for the selected range. In automatic or manual range, 1000 flashes if the sample is over the instrument's range. In manual range mode, select the next higher range mode if 9.99 or 99.9 flashes. See *Section 2.3.6* on page 31 for measuring overrange samples. The display will stop flashing if a sample within range is inserted and read.

#### 5.4.2 E Messages

An error message indicates either an instrument failure or an operation cannot be performed. **An error message can be cleared by pressing DIAG** (display will return to previous measurement or calibration value). The meter continues to operate as best it can. If the message occurs during a calibration, calibration can continue. If the error message occurs when a calibration is being calculated, the instrument will discard the new calibration and retain the old calibration. Error messages and corrective actions are listed below.

#### 5.4.3 CAL?

A flashing CAL? appears when the instrument is using the default calibration programmed at the factory. It will appear if the analyst has erased the user-entered calibration using the procedure to restore the default calibration or after an E 4 error is cleared by pressing DIAG. Recalibrate as soon as possible when CAL? appears. CAL? (not flashing) appears when a calibration has questionable validity.

## SECTION 5, continued

Message*	Probable Cause	Corrective Action
E1	Dilution water is $\geq 0.5$ NTU.	Start calibration over with better quality dilution water or use a membrane filter to filter the water before use.
E2	Two standards have the same value or their difference is less than 60 NTU.  Not all standards were read during the calibration.  Standard 1 is too low ( $<10$ NTU).	Recheck preparation of standards and repeat calibration.
E3	Low light error.	Re-read measurement.  Check lamp**  Check for obstructed light path.  Dilution may be necessary.
E4	EEPROM malfunction.	Check sum failed. Press <b>I/O</b> . If E 4 reappears, call Hach service. If <b>CAL?</b> appears, recalibrate.
E5	A/D overrange.	Check for obstructed light path.  Call Hach Service.
E6	A/D underrange.	Check for open lid during reading and re-read. Check for obstructed light path. If persists, call Hach Service.
E7	Light Leak.	Close lid before pressing <b>READ</b> key.
E8	Bad lamp circuit.	Reinsert lamp leads at terminal block-make sure the lead ends are not touching each other.If this fails, call Hach Service.

\* Error messages 4, 5, and 6 may indicate a failure in the internal electronics.

\*\* Check lamp by inserting a pencil or piece of paper into the cell compartment and pressing READ. Light should be visible on the inserted object.





## **GENERAL INFORMATION**

**At Hach Company, customer service is an important part of every product we make.**

**With that in mind, we have compiled the following information for your convenience.**

# Replacement Parts & Accessories

---

## REPLACEMENT PARTS

Description	Cat. No.
StablCal Calibration Set for 2100P, Sealed Vials: <0.1 NTU, 20 NTU, 100 NTU, and 800 NTU .....	26594-05
AA Batteries, 4/pkg .....	19380-04
Battery Door .....	46005-00
Carrying Case .....	46506-00
Gelex <sup>®</sup> Standards, set (includes standards and 3 sample cells)	24641-05
Instrument Manual .....	46500-88
Lamp Assembly, with leads .....	46539-00
Oiling Cloth .....	47076-00
Sample Cells, 1 inch, with cap, 6/pkg.....	24347-06
Silicone Oil, 15 mL.....	1269-36

## OPTIONAL ACCESSORIES AND REAGENTS

Deionized Water, 3.78 L .....	272-17
Bath, Ultrasonic, 2.8 L (0.75-gal), w/heater .....	24895-00
Battery Eliminator, 120 V .....	46079-00
Battery Eliminator, 230 V .....	46080-00
Filter, 0.2 micron, 10/pkg .....	23238-10
Formazin, 4000 NTU, 500 mL .....	2461-49
Formazin, 4000 NTU, 100 mL .....	2461-42
Hexamethylenetetramine, 500 g .....	1878-34
Hydrazine Sulfate, 100 g .....	742-26
NiCad Rechargeable Battery (4 required) .....	16077-00

## Replacement Parts & Accessories, continued

---

### OPTIONAL ACCESSORIES AND REAGENTS, continued

Description	Cat. No.
Pipet, TenSette®*, 1-10 mL.....	19700-10
Pipet Tips, for 1-10 mL TenSette Pipet, 50/pkg.....	21997-96
Pipet Tips, for 1-10 mL TenSette Pipet, 1000/pkg.....	21997-28
Pipet, Volumetric, Class A, 1.00 mL.....	14515-35
Pipet, Volumetric, Class A, 5.00 mL.....	14515-37
Pump, Vacuum, Hand-Operated.....	14283-00
Sample Degassing Kit.....	43975-00
Sample Filtration and Degassing Kit.....	43975-10
StablCal® Calibration Set for 2100P Turbidimeter	
<0.1, 20, 100, 800 NTU, 500 mL each.....	26594-00
<0.1, 20, 100, 800 NTU, 100 mL each.....	26594-10
<0.1 NTU** StablCal®*** Stabilized	
Formazin Standard, 100 mL.....	26597-42
20 NTU StablCal® Stabilized Formazin Standard, 100 mL.....	26601-42
100 NTU StablCal® Stabilized Formazin Standard, 100 mL...	26602-42
800 NTU StablCal® Stabilized Formazin Standard, 100 mL...	26605-42
Triton-X Solution, 118 mL (4 oz).....	14096-32
Volumetric Flask, 100 mL.....	14574-42
Volumetric Flask, 200 mL.....	14574-45

---

\* TenSette™ is a Hach Company trademark.

\*\* <0.1 NTU StablCal® Standard is used in place of dilution water standard when performing a calibration.

\*\*\* StablCal® is a registered trademark of Hach Company.

# HOW TO ORDER

---

## By Telephone:

6:30 a.m. to 5:00 p.m. MST  
Monday through Friday  
(800) 227-HACH  
(800-227-4224)

By FAX: (970) 669-2932

## By Mail:

Hach Company  
P.O. Box 389  
Loveland, CO 80539-0389  
U.S.A.

---

Ordering information by E-mail: [orders@hach.com](mailto:orders@hach.com)

## Information Required

- Hach account number (if available)
- Your name and phone number
- Purchase order number
- Brief description or model number
- Billing address
- Shipping address
- Catalog number
- Quantity

## Technical and Customer Service (U.S.A. only)

Hach Technical and Customer Service Department personnel are eager to answer questions about our products and their use. Specialists in analytical methods, they are happy to put their talents to work for you. Call **1-800-227-4224** or E-mail [techhelp@hach.com](mailto:techhelp@hach.com).

## International Customers

Hach maintains a worldwide network of dealers and distributors. To locate the representative nearest you, send E-mail to [intl@hach.com](mailto:intl@hach.com) or contact:

### In Canada, Latin America, Africa, Asia, Pacific Rim:

Telephone: (970) 669-3050; FAX: (970) 669-2932

### In Europe, the Middle East, or Mediterranean Africa:

HACH Company, c/o  
Dr. Bruno Lange GmbH  
Willstätterstr. 11  
D-40549 Düsseldorf  
Germany  
Telephone: +49/[0]211.52.88.0  
Fax: +49/[0]211.52.88.231



# REPAIR SERVICE

---

Authorization must be obtained from Hach Company before sending any items for repair. Please contact the HACH Service Center serving your location.

## **In the United States:**

Hach Company  
100 Dayton Avenue  
Ames, Iowa 50010  
(800) 227-4224 (U.S.A. only)  
Telephone: (515) 232-2533  
FAX: (515) 232-1276

## **In Canada:**

Hach Sales & Service Canada Ltd.  
1313 Border Street, Unit 34  
Winnipeg, Manitoba  
R3H 0X4  
(800) 665-7635 (Canada only)  
Telephone: (204) 632-5598  
FAX: (204) 694-5134  
E-mail: [canada@hach.com](mailto:canada@hach.com)

## **In Latin America, the Caribbean, the Far East, the Indian Subcontinent, Africa, Europe, or the Middle East:**

Hach Company World Headquarters  
P.O. Box 389  
Loveland, Colorado, 80539-0389  
U.S.A.  
Telephone: (970) 669-3050  
FAX: (970) 669-2932  
E-mail: [intl@hach.com](mailto:intl@hach.com)

# WARRANTY

---

Hach warrants most products against defective materials or workmanship for at least one year from the date of shipment; longer warranties may apply to some items.

**HACH WARRANTS TO THE ORIGINAL BUYER THAT HACH PRODUCTS WILL CONFORM TO ANY EXPRESS WRITTEN WARRANTY GIVEN BY HACH TO THE BUYER. EXCEPT AS EXPRESSLY SET FORTH IN THE PRECEDING SENTENCE, HACH MAKES NO WARRANTY OF ANY KIND WHATSOEVER WITH RESPECT TO ANY PRODUCTS. HACH EXPRESSLY DISCLAIMS ANY WARRANTIES IMPLIED BY LAW, INCLUDING BUT NOT BINDING TO ANY WARRANTY OF MERCHANTABILITY OR FITNESS FOR A PARTICULAR PURPOSE.**

**LIMITATION OF REMEDIES:** Hach shall, at its option, replace or repair nonconforming products or refund all amounts paid by the buyer. **THIS IS THE EXCLUSIVE REMEDY FOR ANY BREACH OF WARRANTY.**

**LIMITATION OF DAMAGES: IN NO EVENT SHALL HACH BE LIABLE FOR ANY INCIDENTAL OR CONSEQUENTIAL DAMAGES OF ANY KIND FOR BREACH OF ANY WARRANTY, NEGLIGENCE, ON THE BASIS OF STRICT LIABILITY, OR OTHERWISE.**

This warranty applies only to Hach products purchased and delivered in the United States.

Catalog descriptions, pictures and specification, although accurate to the best of our knowledge, are not a guarantee or warranty.

For a complete description of Hach Company's warranty policy, request a copy of our Terms and Conditions of Sale for U.S. Sales from our Customer Service Department.



**STANDARD OPERATING PROCEDURE**  
**MAINE VOLUNTEER RIVER MONITORING PROGRAM**  
**METHODS FOR USING THE LAMOTTE 2020e**  
**TURBIDIMETER IN RIVERS AND STREAMS**



## Volunteer River Monitoring Program

### Standard Operating Procedure Methods for using the LaMotte 2020e Turbidimeter

**1. Applicability.** This standard operating procedure is used by the Volunteer River Monitoring Program (VRMP) of the Maine Department of Environmental Protection's (DEP's) Bureau of Water Quality, Division of Environmental Assessment, Watershed Management Unit. It applies to the collection of turbidity (in NTU units) from rivers and streams in Maine using a LaMotte 2020e turbidimeter.

**2. Purpose.** The purpose of this SOP is to provide standardized methods for volunteer groups to determine turbidity of rivers and streams as an instantaneous reading using the LaMotte 2020e turbidimeter.

#### 3. Definitions.

- A. LaMotte.** Manufacturer of water quality monitoring equipment.
- B. Calibration.** Set of procedures established by the manufacturer to ensure that the meter is operating properly; a critical quality assurance step in meter preparation prior to use.
- C. Standard Solutions.** The LaMotte 2020e turbidity meter is supplied with three AMCO™ standards of 0 NTU, 1 NTU, and 10 NTU. These standards were manufactured specifically as a reference to calibrate the 2020e turbidimeter.
- D. NTUs.** Nephelometric Turbidity Units. The units of measurement from a calibrated turbidity meter referred to as a nephelometer.
- E. Tube Positioning Rings.** Rings supplied with the LaMotte 2020e that ensure sampling tubes are positioned in meter chamber in the same orientation from one reading to the next to minimize variations in readings due to differences in tube position.
- F. Blank (or Zero Standard).** A baseline standard calibrator which contains no detectable concentration of the analyte being measured.

#### 4. Responsibilities.

##### *A. Volunteer Monitors & Volunteer Groups*

- **Certification.** It is the responsibility of the individual obtaining this data to maintain current certification for the parameter(s) they collect if they wish their data to be entered into the VRMP database. Training will be provided to volunteers on an annual basis by VRMP/DEP staff, and certification will last for one year from the date of training.

- **Data recording.** It is the responsibility of the individual obtaining this data to record the results and additional qualifying information on current VRMP field sheets obtained from their affiliated watershed association or through the VRMP program of the DEP.
- **Data Quality Checks and Data Submission.** The data manager for the volunteer group will collect and enter volunteer field sheet data onto the appropriate computer file, perform quality assurance checks (refer to Section 5.10 of the Quality Assurance Program Plan), and submit data to the VRMP following protocols outlined in the volunteer group's latest sampling and analysis plan (SAP) that has been approved by the VRMP.

#### ***B. Volunteer River Monitoring Program (VRMP) Staff***

- **Oversight of Volunteer Groups and Volunteers.** VRMP staff will oversee volunteer groups and volunteers through a variety of ways including maintaining an up-to-date VRMP quality assurance program plan (QAPP); reviewing sampling and analysis plans (SAPs) of the volunteer groups; providing annual training/certification sessions for volunteers; conducting quality assurance checks on data submitted by volunteer groups and laboratories; and uploading data into the DEP's EGAD (Environmental and Geographic Analysis Database) database. These tasks are described in greater detail in the VRMP's latest QAPP.

### **5. Guidelines and procedures**

#### ***A. LaMotte 2020e Turbidity Meter Preparation:***

- **First time use.** Follow manufacturer's instructions for preparing meter for first time use. (Refer to Appendix A:
  - Section "Options and Set Up"; sub-sections "Selecting Turbidity Units", "Selecting a Turbidity Calibration Curve", "Averaging", "Setting the Date and Time", "Selecting a Language", "Setting Auto Shutdown" (pgs. 8-15);
  - Section "Data Logging" (pgs. 16 – 17);
  - Section "The Tube Positioning Ring" (pg. 18); ensure that turbidity tubes are equipped with Tube Positioning Rings;
  - Sections "General Precautions" and "Safety Precautions" (pg. 39).
- **Beginning of field season.** Before each field season, volunteer monitoring groups shall conduct a full inspection of the meter, turbidity tubes, and expiration dates of all turbidity standards. Tubes should be clean and free from lint, fingerprints, dried spills, and significant scratches. Refer to Appendix A, section "Tubes" (pg. 36) for more information about cleaning and handling turbidity tubes. Also, refer to section "Testing Tips" (pg. 29) for other important considerations (e.g., Tip # 13: "Do not use silicone oil on tubes when testing turbidity with the 2020", which is different than

some other brands of turbidity meters). A new battery shall be installed in the meter at the start of the sampling season and additionally, as needed (refer to Appendix A; section “Battery Operation”, pg. 37).

- **Prior to field sampling.** Before each field sample collection, the volunteer shall inspect the meter including an inspection of the turbidity tubes and expiration dates of turbidity standards.
- **LaMotte 2020e Turbidimeter Calibration.** The LaMotte 2020e meter shall be calibrated at the beginning of each field season and at the beginning of each day of use. The LaMotte 2020e turbidity meter is supplied with three AMCO™ standards of 0 NTU, 1 NTU, and 10 NTU. Calibrate the meter with each of these standards. (For instructions, refer to Appendix A, section “Calibration Procedure”, pgs. 24 – 28. See also “Testing Tips”, pg. 29).

### ***C. Turbidity Measurements:***

- **Sample period and location.** Sampling period and site location will be documented in SAPs (that require approval by the VRMP) which are submitted by the volunteer groups prior to the beginning of a sampling season. (Detailed information regarding how volunteer groups are to obtain and document site location information can be found in VRMP SOP-02 [Methods for Selecting and Documenting Site Locations].)
- **Familiarize Yourself with the Meter.** Volunteers shall familiarize themselves with the basic operation, keypad, and readouts of the meter (Appendix A; section “General Operating Information; pgs. 31 – 35).
- **General Sampling Protocol.**
  - Record site location on data sheet.
  - Turbidity tubes should be wiped with a clean, lint-free cloth (refer to Appendix A, section “Tubes”, pg. 36).
  - Collect water sample at the site where you are monitoring, as described in your group’s approved SAP. (Detailed information regarding how to collect a water sample can be found in VRMP SOP-01 [Methods for Collecting Water Grab Samples in Rivers and Streams].)
  - Follow the instructions specific to measuring turbidity below.
- **Turbidity Measurements.**
  - (1) Review and follow the instructions for making turbidity measurements in section “Analysis & Calibration” (Appendix A, pgs. 18 – 21). Make sure units are taken in NTU.
  - (2) For testing tips, refer to Appendix A, pg. 29
- **Quality Control:**

- (1) At the beginning of each field season, all VRMP staff and VRMP volunteers who will collect turbidity data will have a training/refresher/certification session to (re)familiarize themselves with the contents of this SOP.
- (2) For every volunteer, a field duplicate shall be obtained for all parameters for at least 10% of their own sampling efforts. A field duplicate will be collected for every 10 samples monitored.
- (3) Refer to the VRMP quality assurance program plan (QAPP) for more QA/QC details.

## **6. Equipment Care:**

### ***A. Start of Field Season.***

1. Refer to section 5-A of this document.
2. Use new batteries at start of sampling season. Extra turbidity tubes and an extra set of appropriate size batteries should be included in the meter carrying case.

### ***B. Field Season.***

1. Ideally the meter should be in a water-resistant case with padding to protect it from damage.
2. Allow the case and contents to air-dry at the end of each day. This may be accomplished by simply propping the protective's case's lid open. When contents are very wet, remove the contents and spread out to facilitate drying.
3. Clean turbidity tubes at the end of each sampling day (refer to Appendix A; section "Tubes", pg. 36). Ensure that turbidity tubes are equipped with tube positioning rings (Appendix A; section "The Tube Positioning Ring", pg. 18).
4. Keep meter from freezing.
5. Refer to Appendix A, section "Maintenance", pg. 38 for manufacturer's recommendations for maintenance requirements.

### ***C. End of Field season.***

1. Completely dry meter and case and all items in the case before storing.
2. Remove batteries.
3. Clean turbidity tubes according to manufacturer's instructions (refer to Appendix A, section "Tubes", pg. 36).
4. Keep meter dry and at room temperature to prevent corrosion of electronic parts.
5. Record winterization date and equipment repairs in Equipment Log.
6. Label the meter and case as "WINTERIZED" in an obvious manner (so users will know the current status of the unit.)

**7. Specifications**

Display	Range	Accuracy	Resolution
Turbidity (NTU)	0.00 – 2000 NTU	.05 or $\pm 2\%$ for readings below 100 NTU, whichever is greater $\pm 3\%$ above 100 NTU	<i>Standard Mode</i> 0.01 from 0.00- 10.99 NTU 0.1 from 11.0 – 109.9 NTU 1 from 110 – 2000 NTU <i>(see owner’s manual for EPA mode)</i>

**8. Appendix.**

**A. LaMotte Turbidimeter 2020e owner’s manual:**

LaMotte Company. 2007. Operations Manual: LaMotte 2020 e/i Turbidity Meter. Chestertown, MD.

**9. References.**

**A. Maine VRMP QAPP:**

- Maine Department of Environmental Protection (MDEP). 2019. Maine Volunteer River Monitoring Program (VRMP) Quality Assurance Program Plan (QAPP). Portland, ME. DEPLW-0984.





# 2020<sup>e/i</sup> Turbidity Meter



2020e • Code 1979-EPA

2020i • Code 1979-ISO

Version 1.5 • Code 1979-MN • 12-07





WARNING! This set contains chemicals that may be harmful if misused. Read cautions on individual containers carefully. Not to be used by children except under adult supervision

---

## CONTENTS

---

<b>Introduction</b> . . . . .	<b>6</b>
Turbidity . . . . .	6
What is Turbidity? . . . . .	6
How is Turbidity Measured? . . . . .	7
Taking Turbidity Water Samples . . . . .	7
Sample Dilution Techniques . . . . .	7-8
<b>Options and Set Up</b> . . . . .	<b>8</b>
Factory Default Settings . . . . .	8
Reset to Factory Default Settings . . . . .	8
Turbidity . . . . .	8
Selecting Turbidity Units . . . . .	8-9
Selecting a Turbidity Calibration Curve . . . . .	10-11
Averaging . . . . .	11-12
Setting Date & Time . . . . .	12-13
Selecting a Language . . . . .	14
Setting Auto Shutdown . . . . .	15
<b>Data Logging</b> . . . . .	<b>16-17</b>
<b>Tube Positioning Ring</b> . . . . .	<b>18</b>
<b>Analysis &amp; Calibration</b> . . . . .	<b>18</b>
Analysis . . . . .	19-21
Dilution Procedures . . . . .	22
Preparation of Turbidity-Free Water . . . . .	22-23
Turbidity Standards . . . . .	24
Calibration Procedure . . . . .	24-28
Testing Tips . . . . .	29
<b>Troubleshooting Guide</b> . . . . .	<b>30</b>
Error Messages . . . . .	30
Troubleshooting . . . . .	30
Stray Light . . . . .	31
<b>General Operating Information</b> . . . . .	<b>30</b>
Overview . . . . .	31
The Keypad . . . . .	32-33
The Display & Menus . . . . .	34-36
Negative Results . . . . .	35
Tubes . . . . .	36
<b>PC LINK</b> . . . . .	<b>37</b>
Output . . . . .	37

Computer Connection . . . . .	37
<b>Battery Operation . . . . .</b>	<b>37</b>
Replacing the Battery . . . . .	37
<b>Maintenance . . . . .</b>	<b>38</b>
Cleaning. . . . .	38
Repairs . . . . .	38
Meter Disposal . . . . .	38
<b>General Information . . . . .</b>	<b>39</b>
Packaging and Delivery. . . . .	39
General Precautions . . . . .	39
Safety Precautions . . . . .	39
Limits of Liability . . . . .	39
Specifications . . . . .	40
Statistical and Technical Definitions Related to Product Specifications . . . . .	41
Contents and Accessories . . . . .	42
EPA Compliance . . . . .	42
ISO Compliance . . . . .	42
CE Compliance. . . . .	42
Warranty . . . . .	42

---

## INTRODUCTION

### TURBIDITY

---

#### What is Turbidity?

---

Turbidity is an aggregate property of the solution, water in most cases. Turbidity is not specific to the types of particles in the water. They could be suspended or colloidal matter and they can be inorganic, organic or biological. At high concentrations turbidity is perceived as cloudiness or haze or an absence of clarity in the water. Turbidity is an optical property that results when light passing through a liquid sample is scattered. The scattering of light results in a change in the direction of the light passing through the liquid. This is most often caused when the light strikes particles in solution and is scattered backward, sideways and forward. If the turbidity is low much of the light will continue in the original direction. Light scattered by the particles allows the particle to be "seen" or detected in solution. Just as sunlight passing through a window is scattered by dust particles in the air, allowing them to be seen.

In the past 10 years, turbidity has become more than just a measure of water clarity. Because of the emergence of pathogens such as *Cryptosporidium* and *Giardia*, turbidity now holds the key to assuring proper water filtration. In 1998, the EPA published the IESWTR (interim enhanced surface water treatment rule) mandating turbidities in combined filter effluent to read at or below 0.3 NTU. By doing so, the EPA hoped to achieve a 2 log (99%) removal of *Cryptosporidium*. There is presently consideration to lower this to 0.1 NTU. The trend has been to check the calibration of on-line turbidimeters with hand-held field units. The optical design and low detection limit of the 2020 allow very accurate readings for such calibrations.

The meter also allows the user to choose the units of measure for expressing turbidity. While nephelometric turbidity unit (NTU) has been the standard for years, FNU (formazin nephelometric unit) and FAU (formazin attenuation unit) are now being used in ISO 7027 units. American Society of Brewing Chemists (ASBC) units and European Brewery Convention (EBC) units allow the brewing industry to check process waters.

#### How is Turbidity Measured?

---

Turbidity is measured by detecting and quantifying the scattering of light in water (solution). Turbidity can be measured in many ways. There are visual methods and instrumental methods. Visual methods are more suitable for samples with high turbidity. Instrumental methods can be used on samples with both high and low levels of turbidity.

Two visual methods are the Secchi Disk method and the Jackson Candle method. The Secchi Disk method is often used in natural waters. A black and white Secchi Disk is lowered into the water until it can no longer be seen. It is then raised until it can be seen again. The average of these two distances is known as the "Secchi Depth". The Jackson Candle method uses a long glass tube over a standard candle. Water is added or removed from the tube until the candle flame becomes indistinct. The depth of the water measured with a calibrated scale is reported as Jackson Turbidity Units (JTU). The lowest turbidity that can be determined with this method is about 25 NTU. There are two common methods for instruments to measure turbidity. Instruments can measure the attenuation of a light beam passing through a sample and they can measure the scattered light from a light beam passing through a sample. In the attenuation method, the intensity of a light beam passing through turbid sample is

compared with the intensity passing through a turbidity-free sample at 180° from the light source. This method is good for highly turbid samples. The most common instrument for measuring scatter light in a water sample is a nephelometer. A nephelometer measures light scattered at 90° to the light beam. Light scattered at other angles may also be measured, but the 90° angle defines a nephelometric measurement. The light source for nephelometric measurements can be one of two types to meet EPA or ISO specifications. The EPA specifies a tungsten lamp with a color temperature of 2,200–3,000 K. The units of measurement for the EPA method are nephelometric turbidity units (NTU). The ISO specifies a light emitting diode (LED) with a wavelength of 860 nm and a spectral bandwidth less than or equal to 60 nm. The units of measurement for the ISO method are formazin nephelometric units (FNU). The 2020e meets the EPA specification and the 2020i meets the ISO specification. The nephelometric method is most useful for low turbidity.

The 2020 is a nephelometer that is capable of measuring turbidity by both the attenuation method and the nephelometric method. It uses a detector placed at 180° to the light source for the attenuation method. It uses a detector placed at 90° to the light source for the Nephelometric method. The 2020 also has a third detector that monitors the intensity of the light source. It uses this detector to improve instrumental stability and minimize calibration drift. The 2020 also has a signal averaging option to improve the stability of readings on low turbidity samples.

The 2020 has two different turbidity calibrations, formazin and Japan Standard. The formazin calibration is the EPA and ISO approved method of calibrating nephelometers. This calibration can be used with user prepared formazin standards or commercially purchased formazin standards. LaMotte Company approved AMCO™ standards labeled for use with the 2020 can also be used with the formazin calibration. Stabcal® standards below 50 NTU should not be used to calibrate the 2020.

The Japan Standard calibration is a calibration for a Japanese Water Works standard. It is based on Japanese formulated polystyrene turbidity standards. This calibration should only be use to meet Japanese Water Works requirements. The Japanese polystyrene standards can only be purchased in Japan. Formazin, AMCO and Stabcal® standards cannot be used with this calibration.

## Taking Turbidity Water Samples

Clean plastic or glass containers may be used for turbidity samples. Ideally, samples should be tested soon after collection and at the same temperature as when collected.

## SAMPLE DILUTION TECHNIQUES

If a test result is out of the range of the meter, it must be diluted. The test should then be repeated on the diluted sample. The following table gives quick reference guidelines for dilutions of various proportions.

Amount of Sample	Deionized Water to Bring Final Volume to 10 mL	Multiplication Factor
10 mL	0 mL	1
5 mL	5 mL	2
2.5 mL	7.5 mL	4
1 mL	9 mL	10
0.5 mL	9.5 mL	20

All dilutions are based on a final volume of 10 mL so several dilutions will require small volumes of the water sample. Graduated pipets should be used for all dilutions. If volumetric glassware is not available, dilutions can be made with the colorimeter tube. Fill the tube to the 10 mL line with the sample and then transfer it to another container. Add 10 mL volumes of deionized water to the container and mix. Transfer 10 mL of the diluted sample to the colorimeter tube and follow the test procedure. Repeat the dilution and testing procedures until the result falls within the range of the calibration. Multiply the test result by the dilution factor. For example, if 10 mL of the sample water is diluted with three 10 mL volumes of deionized water, the dilution factor is four. The test result of the diluted sample should be multiplied by four.

---

## OPTIONS & SET UP

### FACTORY DEFAULT SETTINGS

---

Settings that have user options have been set at the factory to default settings.

*The factory default settings are:*

Turbidity Units	NTU
Turbidity Calibration	formazin
Averaging	Disabled
Date Format	MM/DD/YY
Language	English
Auto Shutdown	Disabled

### RESET TO FACTORY DEFAULT SETTINGS

---

To return the meter to the factory settings, turn the meter off. Hold down **\*IOK** button. Press **ON**. Release both buttons. Press **\*IOK** button to select the default settings. Meter will turn off and the factory settings will be restored. Restoring the factory settings will remove the user-level calibration but not the zeroing. To change the default settings follow the instructions in the following sections.

### TURBIDITY

---

The default units are NTU and the default calibration curve is formazin. To change the settings:

#### SELECTING TURBIDITY UNITS

1. Press **ON** to turn the meter on.



1.3



2. Scroll down and then press **\*IOK** to select **Options**.

<b>Main Menu</b>	
Measure Data Logging * Options	
<b>16:02:19</b>	<b>01/04/05</b>

3. Scroll down and then press **\*IOK** to select **Turbidity**.

<b>Options</b>	
Averaging * Turbidity Date/Time Language	
<b>16:02:19</b>	<b>01/04/05</b>

4. Press the **\*IOK** to select **Units**.

<b>Turbidity</b>	
* Units Calibration	
<b>16:02:19</b>	<b>01/04/05</b>

5. Scroll down and then press **\*IOK** to select units.  
Available units are: **NTU** (Nephelometric Turbidity Units); **FNU** (Formazin Nephelometric Units); **ASBC** (American Society of Brewing Chemists); **EBC** (European Brewery Convention)

<b>Units</b>	
NTU FNU ASBC EBC	
<b>16:02:19</b>	<b>01/04/05</b>

*Note:* If Attenuation is chosen as a calibration curve. The result will be reported in FAU (Formazin Attenuation Units).

6. Press **◀** to exit to a previous menu or make another menu selection or press **OFF** to turn the meter off.


## SELECTING A TURBIDITY CALIBRATION CURVE

1. Press **ON** to turn the meter on.



2. Scroll down and then press **\*IOK** to select **Options**.

<b>Main Menu</b>
Measure Data Logging * Options
16:02:19 01/04/05

3. Scroll down and then press **\*IOK** to select **Turbidity**.

<b>Options</b>
Averaging * Turbidity Date/Time Language
16:02:19 01/04/05

4. Scroll down and then press **\*IOK** to select **Calibration**.

<b>Turbidity</b>
Units * Calibration
16:02:19 01/04/05

5. Scroll down and then press **\*IOK** to select a **Calibration** curve. Select a calibration option based on the composition of the standards that will be used to calibrate the meter. Available options are: **Formazin**, **Japan Standard**, **Attenuation**.

<b>Turbidity</b>
Units * Calibration
16:02:19 01/04/05

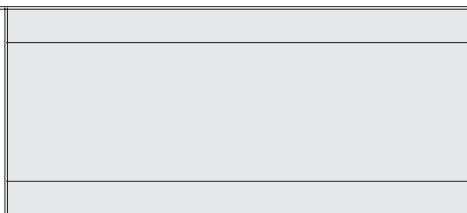
For the most accurate results, the Attenuation option should be chosen when samples are over 500 NTU. The range for the Attenuation option is 40–4000 NTU.

<b>Calibration</b>
* Formazin Japan Standard Attenuation
16:02:19 01/04/05

The Japan Standard calibration mode should be used only with Japanese Polystyrene Standards (0–100 NTU).

Note: StablCal® standards below 50 NTU should not be used to calibrate the 2020. The diluent has a different refractive index than traditional formazin standards and will affect the results.

6. Press **◀** to exit to a previous menu or make another menu selection or press **OFF** to turn the meter off.



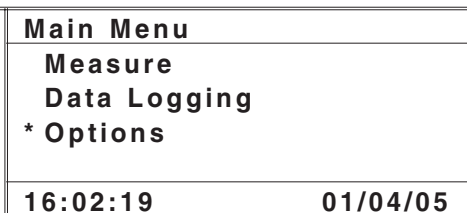
## AVERAGING

The averaging option allows the user to average multiple readings. This option will improve the accuracy of samples with readings that may tend to drift with time. When the two, five or ten reading options have been selected, the meter will show a running average of the readings that have been taken until the final average is displayed. The default setting is disabled. To change the setting:

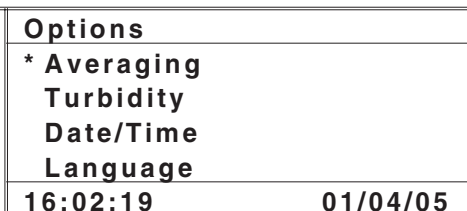
1. Press **ON** to turn the meter on.



2. Scroll down and then press **\*IOK** to select **Options**.



3. Press **\*IOK** to select **Averaging**.



4. Scroll down and then press **\*IOK** to select an averaging option.

Available options are:

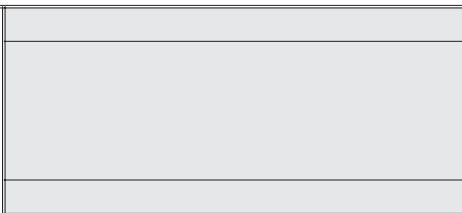
**Disabled, 2 Measurements, 5 Measurements, 10 Measurements.**

Note: The **\*** is displayed next to the current setting.

<b>Averaging</b>	
<b>Disabled</b>	
<b>* 2 Measurements</b>	
<b>5 Measurements</b>	
<b>10 Measurements</b>	
<b>16:02:19</b>	<b>01/04/05</b>

5. Press **<** to exit to a previous menu or make another menu selection or press **OFF** to turn the meter off.

Note: When the Averaging option is selected, it will take longer to get the final result and more power will be used.



## SETTING THE DATE AND TIME

1. Press **ON** to turn the meter on.



2. Scroll down and then press **\*IOK** to select **Options**.

<b>Main Menu</b>	
<b>Measure</b>	
<b>Data Logging</b>	
<b>* Options</b>	
<b>16:02:19</b>	<b>01/04/05</b>

3. Scroll down and then press **\*IOK** to select **Date/Time**.

<b>Options</b>	
<b>Averaging</b>	
<b>Turbidity</b>	
<b>* Date/Time</b>	
<b>Language</b>	
<b>16:02:19</b>	<b>01/04/05</b>

4. Press **\*IOK** to select **Set Date** or scroll down and then press **\*IOK** to select **Set Time** or **Date Format**.

<b>Date/Time</b>	
* <b>Set Date</b>	
<b>Set Time</b>	
<b>Date Format</b>	
<b>16:02:19</b>	<b>01/04/05</b>

5. When setting the time or the date, use the ▼ or ▲ to change the highlighted number on the display. Press **\*IOK** to accept the value and move to the next value.

<b>Set Date</b>	
<b>01/04/05</b>	
▼ , * , ▲	
<b>16:02:19</b>	<b>01/04/05</b>

<b>Set Date</b>	
<b>01/04/05</b>	
▼ , * , ▲	
<b>16:02:19</b>	<b>01/04/05</b>

<b>Set Date</b>	
<b>01/04/05</b>	
▼ , * , ▲	
<b>16:02:19</b>	<b>01/04/05</b>

When choosing a date format, use the ▼ or ▲ to select a date format. Press **\*IOK** to accept format

<b>Date/Time</b>	
* <b>Set Date</b>	
<b>Set Time</b>	
<b>Date Format</b>	
<b>16:02:19</b>	<b>01/04/05</b>

6. Press ◀ to exit to a previous menu or make another menu selection or press **OFF** to turn the meter off.


## SELECTING A LANGUAGE

---

The default setting is English. To change the setting:

1. Press **ON** to turn the meter on.



1.3

2. Scroll down and then press **\*IOK** to select **Options**.

**Main Menu**

**Measure**

**Data Logging**

**\* Options**

16:02:19

01/04/05

3. Scroll down and then press **\*IOK** to select **Language**.

**Options**

**Averaging**

**Turbidity**

**Date Time**

**\* Language**

16:02:19

01/04/05

4. Scroll down and then press **\*IOK** to select a language.  
Available languages are: **English**, **French**, **Spanish**, **Japanese** (Kana), **Portuguese**, **Italian**.

**Language**

**\* English**

**Frances**

**Español**

**Japanese**

16:02:19

01/04/05

5. Press **◀** to exit to a previous menu or make another menu selection or press **OFF** to turn the meter off.

## SETTING AUTO SHUTDOWN

---

The power saving Auto Shutdown feature will turn the meter off when a button has not been pushed for a set amount of time. The default setting is disabled. To change the setting:

1. Press **ON** to turn the meter on.



1.3

2. Scroll down and then press **\*IOK** to select **Options**.

Main Menu

Measure  
Data Logging  
\* Options

16:02:19

01/04/05

3. Scroll down and then press **\*IOK** to select **Auto Shutdown**.

Options

Turbidity  
Date/Time  
Language  
\* Auto Shutdown

16:02:19

01/04/05

4. Scroll up and then press **\*IOK** to select a shutdown time.  
Available options are: **5 minutes**,  
**10 minutes**, **30 minutes**,  
**Disabled**.

Auto Shutdown

\* 5 Minutes  
10 Minutes  
30 Minutes  
Disabled

16:02:19

01/04/05

5. Press **◀** to exit to a previous menu or make another menu selection or press **OFF** to turn the meter off.

## DATA LOGGING

The default setting for the data logger is start (on). The meter will log the last 4004 data points.

1. Press **ON** to turn the meter on.



1.3

2. Scroll down and press **\*IOK** to select **Data Logging**.

**Main Menu**

**Measure**

**\* Data Logging  
Options**

16:02:19

01/04/05

3. Press **\*IOK** to view the last data point that was logged.

**Data Logging**

**\* View**

**Stop**

**Erase**

16:02:19

01/04/05

4. Press **▼** or **▲** to scroll through the saved data points.

**304 / 304**

**1.58 NTU**

**Turbidity**

**(F)**

16:26:58

09/11/04

16:02:19

01/04/05

Note:

If the data logger is empty because it has never been used or has just been erased, the view function will not work.

Or scroll down and press **\*IOK** to select **Stop** or **Start** to stop or start the data logging feature.

**Data Logging**

**View**

**\* Stop**

**Erase**

16:02:19

01/04/05

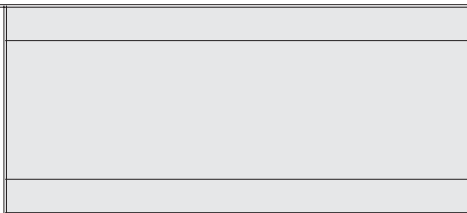


Or scroll down and press **\*IOK** to select **Erase** to empty all logged data points from the memory.

<b>Data Logging</b>	
View * Start Erase	
16:02:19	01/04/05

<b>Data Logging</b>	
View Stop * Erase	

5. Press **OFF** to turn the meter off or press **◀** to exit to a previous menu or make another menu selection.



---

## TUBE POSITIONING RING

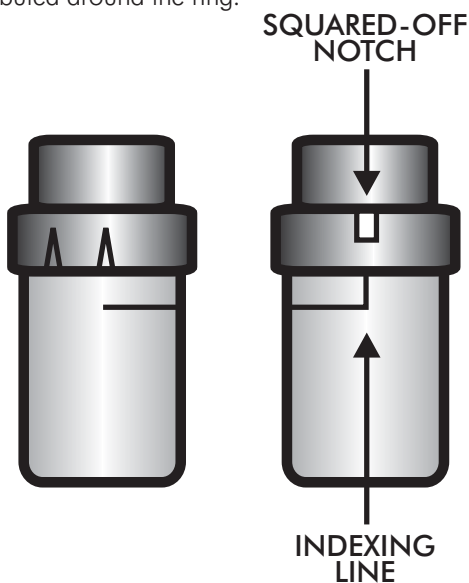
### The Tube Positioning Ring

---

To put a ring on a tube, remove the cap from the tube.

The tube positioning ring has two tapered notches and one squared-off notch. Place the ring on the tube with the squared-off notch closest to the top of the tube and tapered notches closer to the bottom of the tube. Align the single, squared-off notch with the vertical, white indexing line that is printed on the tube. Place the tube flat on a hard surface and firmly press the ring onto the tube with equal pressure distributed along the top of the ring.

To remove a ring, invert the uncapped tube on a soft surface, such as a paper towel. Press down on the ring with equal pressure distributed around the ring.



---

## ANALYSIS & CALIBRATION

The default units are NTU and the default calibration curve is formazin. When **(F)** is displayed in the upper right corner of the display, this indicates that the meter is in the formazin mode. For the most accurate results, a user calibration should be performed. The Attenuation calibration option should be used when samples are over 500 NTU. The Japan Standard calibration mode should be used only with Japanese Polystyrene Standards (0–100 NTU). To change the settings see the *Set Up* instructions (see page 8).

## ANALYSIS

1. Press **\*ION** to turn the meter on.



1.3

2. Press **\*IOK** to select **Measure**.

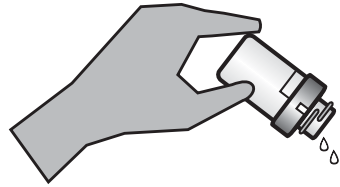
Main Menu

\* Measure  
Data Logging  
Options

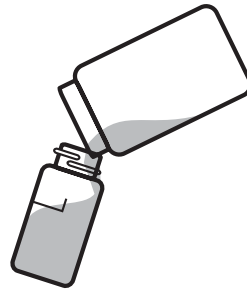
16:02:19

01/04/05

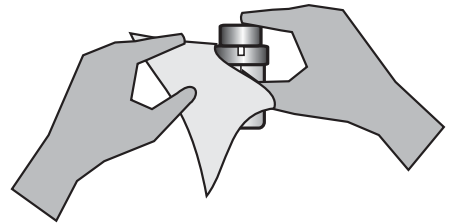
3. Rinse a clean tube (0290) three times with the blank.  
  
For the most accurate results, use the same tube for the blank and the sample.



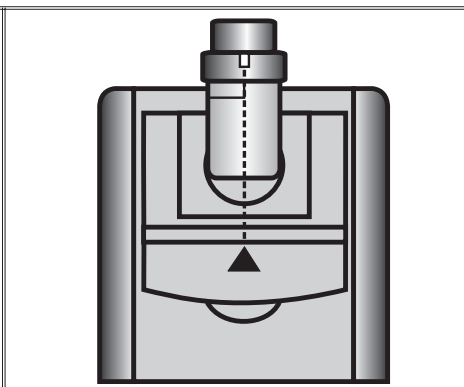
4. Fill the tube to the fill line with the blank. Pour the blank down the inside of the tube to avoid creating bubbles.



5. Dry the tube with a lint-free cloth. Put on a dry positioning ring. Cap the tube. Wipe the tube thoroughly again with a lint-free cloth.



6. Open the meter lid. Insert the tube into the chamber. Align the index notch on the positioning ring with the index arrow on the meter. Close the lid.



7. Press **\*IOK** to select **Scan Blank**. Remove the tube.

**NOTE:** For the best accuracy, especially at low turbidity, see Tip 17 on page 29.

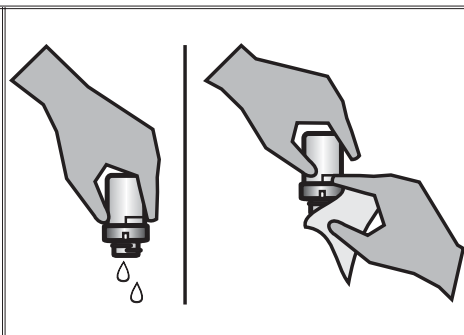
**Turbidity** (F)

\* Scan Blank ▼

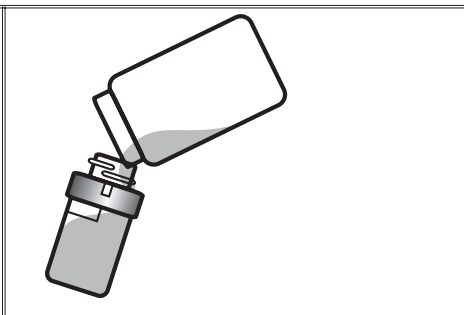
16:02:19

01/04/05

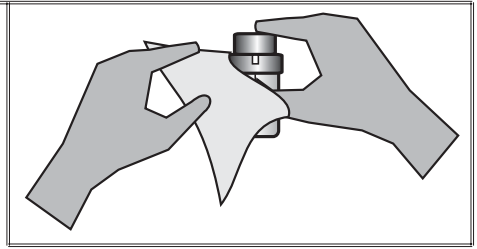
8. Rinse a clean tube (0290), or the same tube, three times with the water to be tested. Avoid spilling water on the outside of the tube. **IMPORTANT:** While the tube is inverted, wipe the lip of the tube to remove droplets of liquid that may be present. This will prevent liquid from being trapped under the ring when the tube is returned to an upright position.



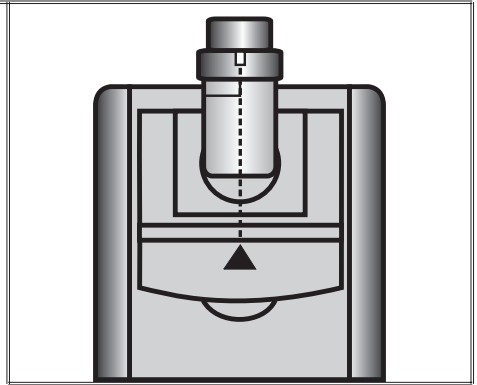
9. Fill the tube to the fill line with the sample. Pour the sample down the inside of the tube to avoid creating bubbles.



10. Cap the tube. Wipe the tube thoroughly again with a lint-free cloth.



11. Open the meter lid. Insert the tube into the chamber. Align the index notch on the positioning ring with the index arrow on the meter. Close the lid.



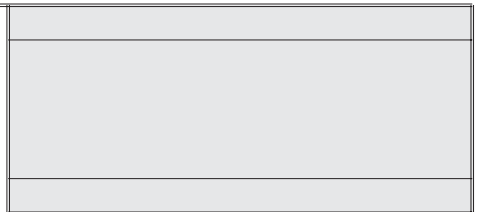
12. Press **\*IOK** to select **Scan Sample**.

<b>Turbidity</b>	<b>(F)</b>
* <b>Scan Sample</b>	▼
<b>16:02:19</b>	<b>01/04/05</b>

13. Record the result.

<b>Turbidity</b>	<b>(F)</b>
<b>0.54</b>	<b>NTU</b>
* <b>Scan Sample</b>	▼
<b>16:02:19</b>	<b>01/04/05</b>

14. Press **OFF** to turn the meter off or press **◀** to exit to a previous menu or make another menu selection.



*Note:* The meter will remember the last scanned blank reading. It is not necessary to scan a blank each time the test is performed. To use the previous blank reading, instead of scanning a new one, scroll to Scan Sample and proceed. For the most accurate results, the meter should be blanked before each test and the same tube with tube positioning ring should be used for the blank and the reacted sample.

## Dilution Procedures

---

If a sample is encountered that is more than 4000 NTU, a careful dilution with 0 NTU or very low turbidity water will bring the sample into an acceptable range. However, there is no guarantee that halving the concentration will exactly halve the NTU value. Particulates often react in an unpredictable manner when diluted.

## Turbidity-Free Water

---

The definition of low turbidity and turbidity-free water has changed as filter technology has changed and nephelometric instruments have become more sensitive. At one time turbidity-free water was defined as water that had passed through a 0.6 micron filter. Now 0.1 micron filters are available and higher purity water is possible. Water that has been passed through a 0.1 micron filter could be considered particle free and therefore turbidity free, 0 NTU water. Turbidity is caused by scattered light. Therefore, low turbidity water is water without any particles that scatter a measurable amount of light. But water that passed through a 0.1 micron filter may still have detectable light scatter with modern instruments. This light scattering can be the result of dissolved molecules or sub-micron sized particles that can not be filtered out of the water. Because there may still be a small amount of scattered light from dissolved molecules, high purity water is often called low turbidity water and assigned a value of 0.01 or 0.02 NTU. However, because this water is used as a baseline to compare to sample water, the difference between the sample and the low turbidity or turbidity-free water will be the same whether it is called 0.00 NTU or 0.02 NTU. For design simplicity the 2020 uses the term turbidity-free water and the value of 0.00 NTU.

## Preparation of Turbidity-Free Water

---

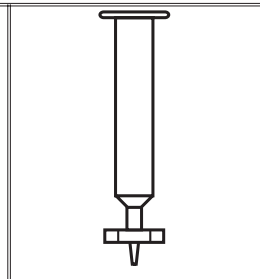
A 0 NTU Standard (Code 1480) is included with the meter. An accessory package (Code 4185) is available for preparing turbidity-free water for blanking the meter and dilution of high turbidity samples.

The preparation of turbidity-free water requires careful technique. Introduction of foreign matter will affect the turbidity reading. A filtering device with a special membrane filter is used to prepare turbidity-free water. The filter, filter holder and syringe must be conditioned by forcing at least two syringes full of deionized water through the filtering apparatus to remove foreign matter. The first and second rinses should be discarded. Turbidity-free water as prepared below may be stored in the dark at room temperature in a clean glass bottle with a screw cap and used as required. The storage container should be rinsed thoroughly with filtered deionized water before filling. The water should be periodically inspected for foreign matter in bright light.

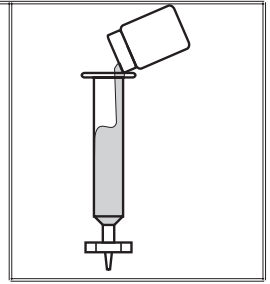
## PROCEDURE

---

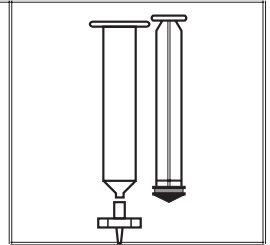
1. Remove the plunger from the syringe (0943). Attach the filter to the bottom of the syringe.



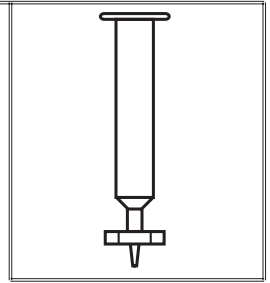
2. Pour approximately 50 mL of deionized water into the barrel of the syringe. Insert the plunger. Exert pressure on the plunger to slowly force the water through the filter. Collect water in the clean storage container. Rinse walls of the container then discard this rinse water.



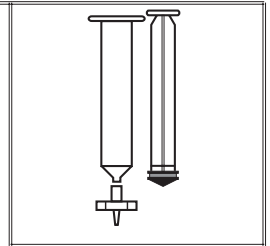
3. Remove the filter from the syringe. Remove the plunger from the barrel. (This step is required to prevent rupturing the filter by the vacuum that would be created when the plunger is removed.)



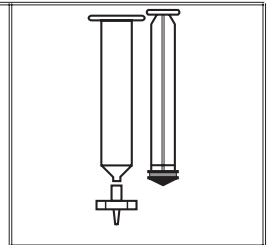
4. Replace the filter and repeat step 2 for a second rinse of the syringe and storage container.



5. Remove the filter from the syringe. Remove the plunger from the barrel. Replace the filter and fill the syringe with approximately 50 mL of deionized water. Filter the water into the storage container and save this turbidity-free water.



6. Repeat Step 5 until the desired amount of turbidity-free water has been collected.



## Turbidity Standards

Only use AMCO or formazin standards with the 2020. StablCal® standards below 50 NTU should not be used to calibrate the 2020. The diluent used in StablCal® standards has a different refractive index than traditional formazin standards and will affect the results. The concentration of the calibration standard should be similar to the expected concentration of samples that will be tested. The following standards are available from LaMotte Company:

1480	0 NTU Standard, 60 mL (EPA and ISO)
1484	1 NTU Standard, 60 mL (EPA)
1481	1 NTU Standard, 60 mL (ISO)
1485	10 NTU Standard, 60 mL (EPA)
1482	10 NTU Standard, 60 mL (ISO)
1486	100 NTU Standard, 60 mL (EPA)
1483	100 NTU Standard, 60 mL (ISO)

## CALIBRATION PROCEDURE

1. Press **\*ION** to turn the meter on.



1.3

2. Press **\*IOK** to select **Measure**.

Main Menu

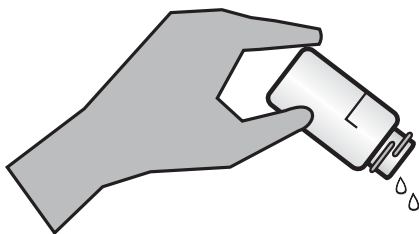
\* Measure  
Data Logging  
Options

16:02:19

01/04/05

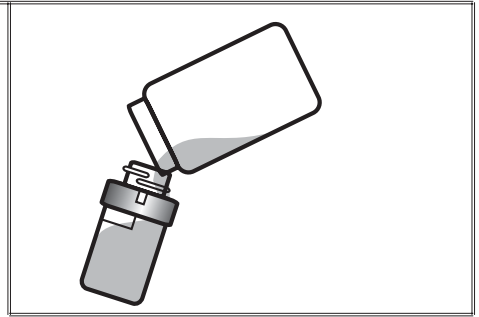
3. Rinse a clean tube (0290) three times with the blank.

Below 1 NTU – The meter should be blanked with a 0 NTU Primary Standard or prepared turbidity-free (<0.1 NTU) water. For the most accurate results, use the same tube for the blank and the sample.

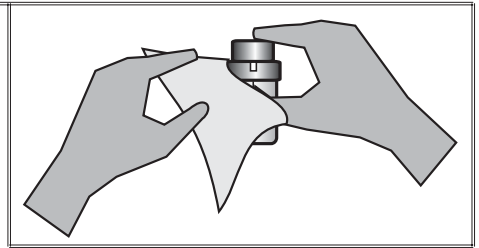




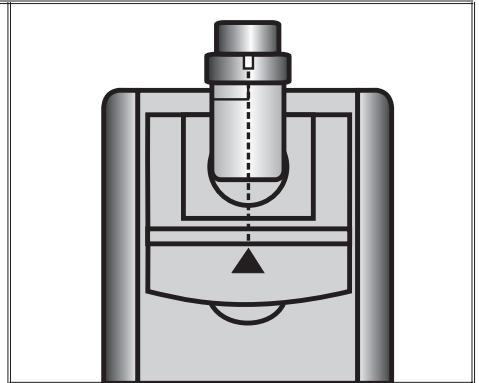
4. Fill the tube to the fill line with the blank. Pour the blank down the inside of the tube to avoid creating bubbles. Cap the tube.



5. Dry the tube with a lint-free cloth. Put on a dry positioning ring. Cap the tube. Wipe the tube thoroughly again with a lint-free cloth.



6. Open the meter lid. Insert the tube into the chamber. Align the index notch on the positioning ring with the index arrow on the meter. Close the lid.



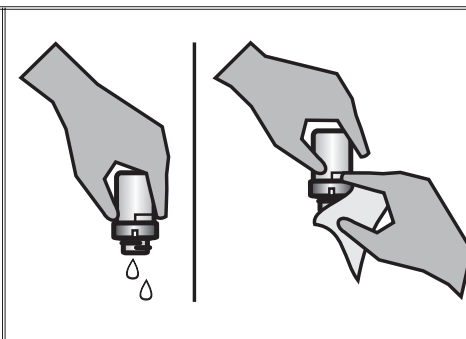
7. Press **\*IOK** to select **Scan Blank**. Remove the tube.

**NOTE:** For the best accuracy, especially at low level turbidity, see **Tip 17** on page 29.

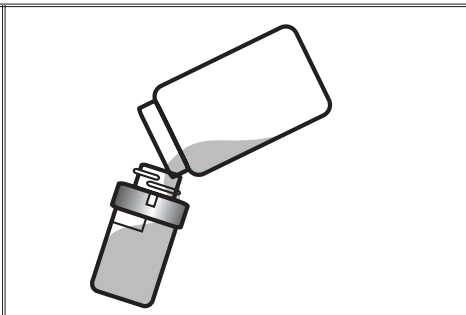
<b>Turbidity</b>	<b>(F)</b>
<b>* Scan Blank</b>	
<b>16:02:19</b>	<b>01/04/05</b>

8. Rinse a clean tube (0290), or the same tube, three times with the standard. Avoid spilling standard on the outside of the tube.

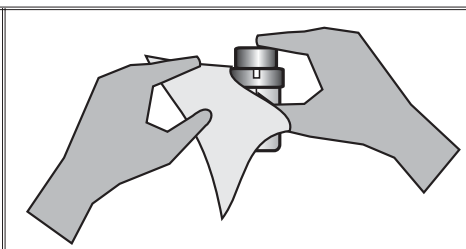
**IMPORTANT:** While the tube is inverted, wipe the lip of the tube to remove droplets of liquid that may be present. This will prevent liquid from being trapped under the ring when the tube is returned to an upright position.



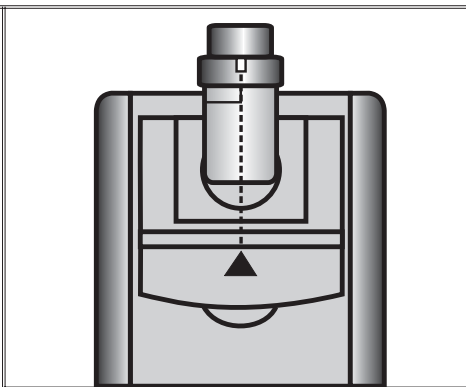
9. Fill the tube to the fill line with the standard. Pour the standard down the inside of the tube to avoid creating bubbles. Cap the tube.



10. Wipe the tube thoroughly again with a lint-free cloth.



11. Open the meter lid. Insert the tube into the chamber. Align the index notch on the positioning ring with the index arrow on the meter. Close the lid.



12. Press **\*IOK** to select **Scan Sample**.

Turbidity	(F)
* Scan Sample	
16:02:19	01/04/05

13. Observe the result.

Turbidity	(F)
<b>0.54</b> NTU	
* Scan Sample ▼	
16:02:19	01/04/05

14. Press ▼ and then press **\*IOK** to select **Calibrate**.

Turbidity	(F)
<b>0.54</b> NTU	
* Calibrate ▼	
16:02:19	01/04/05

15. Use the ▼ or ▲ to change the highlighted digits on the display to match the concentration of the turbidity standard. Press **\*IOK** to accept a digit and move to the next digit.

Calibrate	
<b>00.54</b>	▼, *, ▲
16:02:19	01/04/05

Calibrate	
00. <b>54</b>	▼, *, ▲
16:02:19	01/04/05

Calibrate	
00.5 <b>4</b>	▼, *, ▲
16:02:19	01/04/05

Calibrate	
00.5 <b>0</b>	▼, *, ▲
16:02:19	01/04/05

Calibrate	
00.50	
▼, *, ▲	
16:02:19	01/04/05

16. When the value on the display matches the concentration of the turbidity standard, press the **\*IOK** to select **Set**.

Or press ▼ press **\*IOK** to return the meter to the default setting.

Calibrate	
00.50	
* Set ▼	
16:02:19	01/04/05

Calibrate	
01.15	
* Default ▲	
16:02:19	01/04/05

17. Press **\*IOK** to proceed to Turbidity analysis. Press **OFF** to turn the meter off or press ◀ to exit to a previous menu or make another menu selection.


Note: The meter will remember the last scanned blank reading. It is not necessary to scan a blank each time the test is performed. To use the previous blank reading, instead of scanning a new one, scroll to Scan Sample and proceed. For the most accurate results, the meter should be blanked before each test and the same tube with tube positioning ring should be used for the blank and the reacted sample.

continue next page...

## Testing Tips

---

1. Samples should be collected in a clean glass or polyethylene container.
2. Samples should be analyzed as soon as possible after collection.
3. Gently mix sample by inverting before taking a reading but avoid introducing air bubbles.
4. For the most precise results, follow the recommended procedure for wiping a filled tube before placing it in the meter chamber. Invert tube very slowly and gently three times to mix the sample. Surround the tube with a clean, lint-free cloth. Press the cloth around the tube. Rotate the tube in the cloth three times to assure that all areas of the tube have been wiped.
5. Discard tubes that have significant scratches and imperfections in the light pass zones. (Central zone between bottom and fill line).
6. When reading very low turbidity samples, do not use tubes or caps that have been used previously with high turbidity samples.
7. Use the averaging option for low level measurements of turbidity.
8. The meter should be placed on a surface that is free from vibrations. Vibrations can cause high readings.
9. Turbidity readings will be affected by electric fields around motors.
10. Carbon in the sample will absorb light and cause low readings.
11. Excessive color in a sample will absorb light and cause low readings. The user should verify if a certain level of color will cause a significant error at the level of turbidity being tested.
12. Observe shelf life recommendations for turbidity standards.
13. Do not use silicone oil on tubes when testing turbidity with the 2020.
14. When testing at low concentrations use the same tube for the blank and the sample.
15. Always use the positioning ring. Always insert tube into the meter chamber with the same amount of pressure and to the same depth.
16. Occasionally clean the chamber with a damp lint-free wipe, followed by an alcohol dampened wipe. A clean chamber and tubes are essential for reliable results.
17. For the greatest accuracy during the calibration procedure, be sure that after the meter is blanked and the blank is scanned as a sample, the reading is 0.00. If not, reblank the meter and scan the blank again until it reads 0.00. When scanning the calibration standards as the sample, scan the calibration standard three times removing the tube from the chamber after each scan. The readings should be consistent. Use the last consistent reading to calibrate the meter. If the readings are not consistent, avoid using an aberrant reading to calibrate the meter.

## TROUBLESHOOTING GUIDE

### Error Messages

Err1	Very Low battery. Replace battery or switch to AC power. Press back arrow (◀) to back out. Scan sample again. Replace battery as soon as possible.
Err2	The meter can not be calibrated outside of the allowable range of the displayed reading. Confirm that standard was made correctly. The displayed reading can only be adjusted to $\pm 50\%$ of the factory calibration.
Err3	Meter can not be calibrated with a zero sample. Calibrate the meter with a sample other than zero.
Err4	Processing error due to motion of suspended particles or submicron air bubbles or opening/closing lid during readings. Scan sample again until reading is obtained.
Err5	No blank reading. The meter has never been blanked for this test factor. Blank meter.
Err6	Internal mathematical error. Re-blank the meter and rescan the sample.
Err7	Configuration error. Call LaMotte Tech Service. Meter may have to be returned for repairs.
low battery	Low battery. Change battery.

### Troubleshooting

PROBLEM	REASON	SOLUTION
Lost in meter menus	Reset to factory default settings. (see page 8)	Turn meter off. Hold down * <b>IOK</b> and press <b>ON</b> . Release both buttons. Press * <b>IOK</b> to select the default settings. Meter will turn off and the factory settings will be restored.
Usually large negative or positive readings when performing calibration.	Incorrect standards used to calibrate meter.	Use fresh 0.0 standard in clean, labeled, vial. Reset meter to factory default settings. See procedure above. Recalibrate meter.
Erroneous readings	Measurement was taken with lid open.	Close lid. Read again.
> on display	Over range.	The sample is outside of the acceptable range. Dilute sample and test again.

Meter freezes	Lid was opened when reading was being taken.	Close lid. Read again. Unplug adapter. Plug adapter in to reset.
---------------	--	--

## Stray Light

The accuracy of readings on the 2020 should not be affected by stray light. Make sure that the sample compartment lid is always fully closed when taking readings.

## GENERAL OPERATING INFORMATION

### Overview

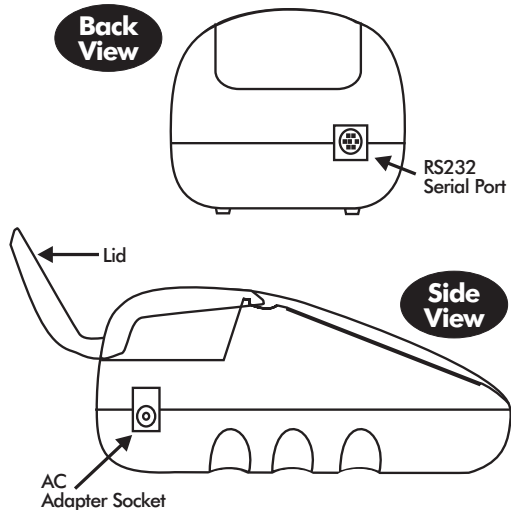
The 2020 is a portable, microprocessor controlled, direct reading nephelometer. Turbidity is measured directly by either EPA Method 180.1 or ISO Method 7027. It has a graphical liquid crystal display and 6 button keypad. These allow the user to select options from the menu driven software, to directly read test results, or to review stored results of previous tests in the data logger. The menus can be displayed in six different languages.

The 2020 uses a state of the art, multi-detector micro optical configuration that assures long term stability of calibrations, high precision and accuracy, and low detection limits. All readings are determined by sophisticated digital signal processing algorithms, minimizing fluctuations in readings and enabling rapid, repeatable measurements. The microprocessor and optics enable a dynamic range and auto-ranging over several ranges. Energy efficient LED light sources are used for ISO turbidity. EPA turbidity uses a tungsten filament light source that meets or exceeds EPA specifications and is designed for a uniform light spot image and stable output.

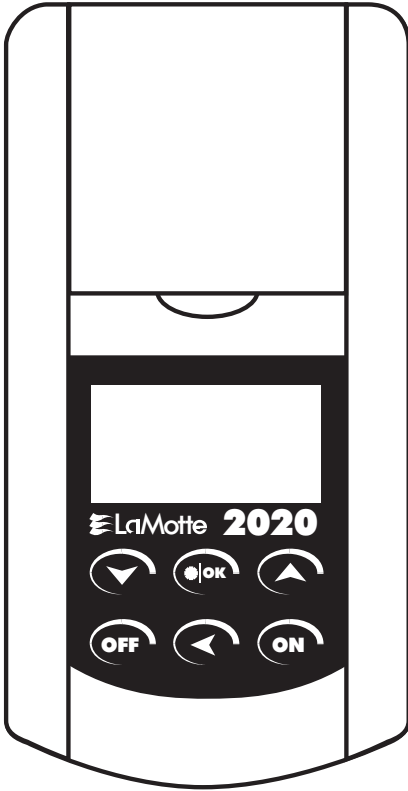
Tube positioning rings are supplied with the 2020. These rings snap onto the shoulders of the tubes. The rings ensure that the tubes are positioned in the chamber in the same orientation from one reading to the next. This minimizes variations in readings due to differences in tube position. This results in greater repeatability and is especially important for samples with low turbidity.

A 9-volt alkaline battery powers the 2020 and an optional AC adapter is available. A fresh battery should be installed at all times even when using the AC adapter.

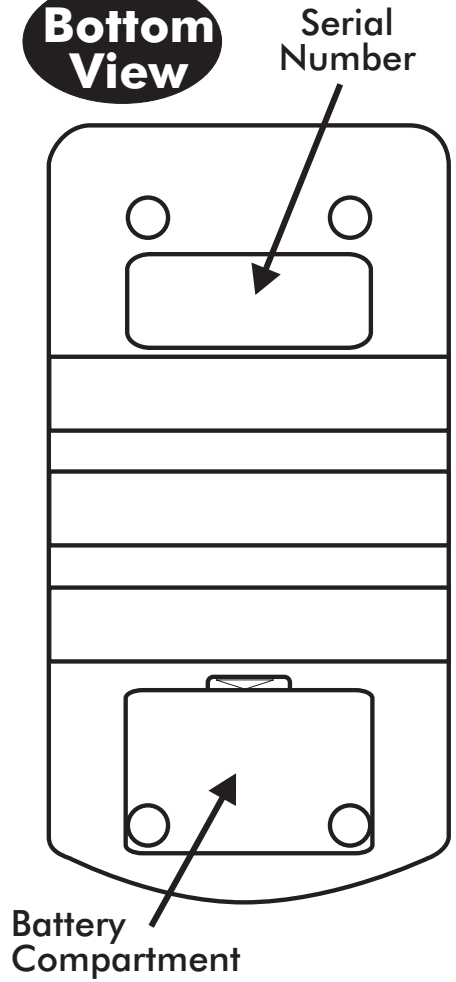
An RS232 serial port on the back of the meter allows an interface of the meter with an IBM compatible computer for real-time data acquisition and data storage using a PC. The 2020 may be interfaced with any Windows-based computer by using the LaMotte SMARTLink 2 Program. The port also allows an interface with an RS232 serial printer.



## Top View



## Bottom View





## General Operating Information

---

The operation of the 2020 is controlled by the menu driven software and user interface. A menu is a list of choices. This allows a selection of various tasks for the 2020 to perform, such as, scan blank and scan sample. The keypad is used to make menu selections that are viewed on the display.

### The Keypad

---

- ▼ This button will scroll down through a list of menu selections.

---

- \*|OK** This button is used to select menu choices adjacent to the \* in a menu viewed in the display

---

- ▲ This button will scroll up through a list of menu selections.

---

- OFF** This button turns the 2020 off.

---

- ◀ This button is an exit or escape button. When pressed, the display will exit the current menu and go to the previous menu.

---

- ON** This button is used to turn on the 2020.

---




## The Display & Menus

The display allows menu selections to be viewed and selected. These selections instruct the 2020 to perform specific tasks. The menus are viewed in the display using two general formats that are followed from one menu to the next. Each menu is a list of choices or selections.

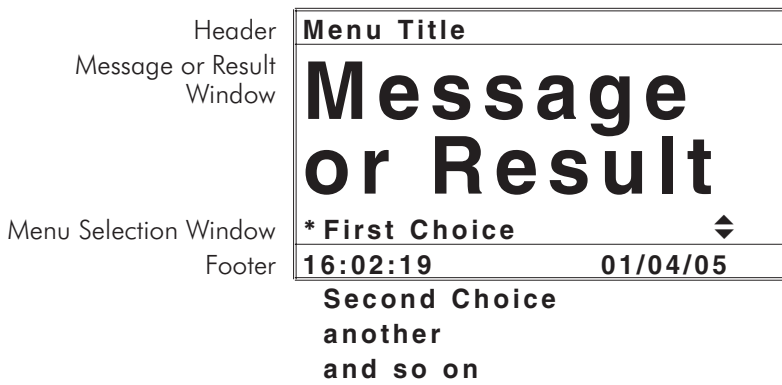
The display has a header line at the top and a footer line at the bottom. The header displays the title of the current menu. The footer line displays the time and the date. The menu selection window is in the middle of the display between the header and the footer.

The menu selection window displays information in two general formats. In the first format only menu selections are displayed. Up to 4 lines of menu selections may be displayed. If more selections are available they can be viewed by pressing the arrow buttons (▲ or ▼) to scroll the other menu selections into the menu selection window. Think of the menu selections as a vertical list in the display that moves up or down each time an arrow button (▲ or ▼) is pressed. All menus in the 2020 are looping menus. The top and bottom menu choices are connected in a loop. Scrolling down past the bottom of the menu will lead to the top of the menu. Scrolling up past the top of the menu will lead to the bottom of the menu

Header	<b>Menu Title</b>
Menu Selection Window	<b>* First Choice</b> <b>Second Choice</b> <b>Another</b> <b>and another</b>
Footer	<b>16:02:19</b> <b>01/04/05</b> <b>and another</b> <b>and so on</b>

An asterisk, \*, will start in the far left position of the top line in the menu choice window. To move the \* press the up or down arrow buttons (▲ or ▼) to scroll through the menu selections. The \* in the display corresponds with the \***IOK** button. Pushing the \***IOK** button selects the menu choice which is adjacent to the \* in the menu selection window.

In the second format the menu choice window takes advantage of the graphical capabilities of the display. Large format graphic information, such as test results or error messages or the LaMotte logo is displayed. The top three lines of the display are used to display information in a large, easy to read format. The menus work in the same way as previously described but only one line of the menu is visible at the bottom of the display. On the lower right side of the display small up and down arrows (▲ or ▼) indicate that other menu selections are available above or below the one visible lines of the menu.



As described previously, the ◀ button allows an exit or escape from the current menu and a return to the previous menu. This allows a rapid exit from an inner menu to the main menu by repeatedly pushing the ◀ button. Pushing **OFF** at any time will turn the 2020 off.

The display may show the following messages:

<b>Err1 to Err7</b>	Error messages. See Trouble Shooting Guide. (page 30)
<b>low battery</b>	Low battery
>	Over range indicator.
▲▼	More choices are available and can be viewed by scrolling up and/or down through the display.
Header	Identifies the current menu and information on units and reagent systems if applicable. In the data logging mode the number of the data point is displayed and the total number of data points in the memory will be shown.
Footer	Shows current time and date.

### Negative Results

There are always small variations in readings with analytical instruments. Often these variations can be observed by taking multiple readings of the same sample. These variations will fall above and below an average reading. Repeated readings on a 0.00 sample might give readings above and below 0.00. Therefore, negative readings are possible and expected on samples with concentrations at or near zero. This does not mean there is a negative concentration in the sample. It means the sample reading was less than the blank reading. Small negative readings can indicate that the sample was at or near the detection limit. This is a normal variation that results in a negative reading. A large negative reading, however, is not normal and indicates a problem. Some instruments are designed to display negative readings as zero. In this type of instrument, if the meter displayed zero when the result was actually a large negative number there would be no indication that a problem existed. For this reason, the 2020 displays negative numbers.

## Tubes

---

The 2020 uses one type of tube (Code 0290) for the turbidity test. There is no need for a special turbidity tube.

The handling of the tubes is of utmost importance. Tubes must be clean and free from lint, fingerprints, dried spills and significant scratches, especially the central zone between the bottom and the sample line.

Scratches, fingerprints and water droplets on the tube can cause stray light interference leading to inaccurate results when measuring turbidity. Scratches and abrasions will affect the accuracy of the readings. Tubes that have been scratched in the light zone through excessive use should be discarded and replaced with new ones.

Tubes should always be washed on the inside and outside with mild detergent prior to use to remove dirt or fingerprints. The tubes should be allowed to air-dry in an inverted position to prevent dust from entering the tubes. To prevent introducing moisture into the meter chamber, tube positioning rings should be removed before washing tubes. If tubes are washed with tube positioning rings in place, the rings should be removed and thoroughly dried before replacing them on the dry tubes. Dry tubes should be stored with the caps on to prevent contamination.

After a tube has been filled and capped, it should be held by the cap and the outside surface should be wiped with a clean, lint-free absorbent cloth until it is dry and smudge-free. Handling the tube only by the cap will avoid problems from fingerprints. Always set the clean tube aside on a clean surface that will not contaminate the tube. It is imperative that the tubes and light chamber be clean and dry. The outside of the tubes should be dried with a clean, lint-free cloth or disposable wipe before they are placed in the meter chamber.

Tubes should be emptied and cleaned as soon as possible after reading a sample to prevent deposition of particulates on the inside of the tubes. When highly accurate results are required, reduce error by designating tubes to be used only for very low turbidity and very high turbidity testing.

Variability in the geometry of the glassware and technique are the predominate causes of variability in results. Slight variations in wall thickness and the diameter of the tubes may lead to slight variations in the test results. To eliminate this error the tubes should be placed in the chamber with the same orientation each time. The orientation of the tubes in the chamber is controlled by use of a tube positioning ring. For improved accuracy and precision, especially at low concentrations, the tubes should always be used with a positioning ring. (See page 32)

---

## PC LINK

The 2020 may be interfaced with any Windows-based computer by using the LaMotte SMARTLink 2 Program and Interface Cable (Code 1912-3 with 3.5 inch disk or Code 1912-CD with compact disk). The program will store test information and results in a database. The meter may also be interfaced with an RS232 serial printer, using an interface cable (Code 1772) and setting the printer configuration to the Output as described below.

### Output

---

RS232 compatible, asynchronous serial, 9600 baud, no parity, 8 data bits, 1 stop bit.

### Computer Connection

---

RS232 interface connection, 8 pin mini-DIN/9 pin F D-submin. (Order Interface Cable Code 1772).

---

## BATTERY OPERATION

The 2020 may be operated on battery power or using an AC adapter. If using the meter as a bench top unit, use the AC adapter if possible. If using the meter only on battery power, always keep a spare battery on hand.

### Replacing the Battery

---

The 2020 uses a standard 9-volt alkaline battery that is available worldwide. The battery compartment is located on the bottom of the case.

### To replace the battery:

---

1. Open the battery compartment lid.
2. Remove the battery and disconnect the battery from the polarized plug.
3. Carefully connect the new battery to the polarized plug and insert it into the compartment.
4. Close the battery compartment lid.

---

## MAINTENANCE

### Cleaning

---

Clean meter with a damp, lint-free cloth.

DO NOT ALLOW WATER TO ENTER THE METER CHAMBER OR ANY OTHER PARTS OF THE METER.

Clean meter chamber and lenses over LEDs with a lint-free cloth slightly dampened with alcohol.

### Repairs

---

Should it be necessary to return the meter for repair or servicing, pack the meter carefully in a suitable container with adequate packing material. A return authorization number must be obtained from LaMotte Company by calling 800-344-3100 (US only) or 410-778-3100, faxing 410-778-6394, or emailing [tech@lamotte.com](mailto:tech@lamotte.com). Often a problem can be resolved over the phone or by email. If a return of the meter is necessary, attach a letter with the return authorization number, meter serial number, a brief description of problem and contact information including phone and FAX numbers to the shipping carton. This information will enable the service department to make the required repairs more efficiently.

### Meter Disposal

---

Waste Electrical and Electronic Equipment (WEEE)

Natural resources were used in the production of this equipment. This equipment may contain materials that are hazardous to health and the environment. To avoid harm to the environment and natural resources, the use of appropriate take-back systems is recommended. The crossed out wheeled bin symbol on the meter encourages you to use these systems when disposing of this equipment.



Take-back systems will allow the materials to be reused or recycled in a way that will not harm the environment. For more information on approved collection, reuse, and recycling systems contact your local or regional waste administration or recycling service.

---

## GENERAL INFORMATION

### Packaging and Delivery

---

Experienced packaging personnel at LaMotte Company assure adequate protection against normal hazards encountered in transportation of shipments.

After the product leaves LaMotte Company, all responsibility for safe delivery is assured by the transportation company. Damage claims must be filed immediately with the transportation company to receive compensation for damaged goods.

### General Precautions

---

**READ THE INSTRUCTION MANUAL BEFORE ATTEMPTING TO SET UP OR OPERATE THE METER.** Failure to do so could result in personal injury or damage to the meter. The meter should not be used or stored in a wet or corrosive environment. Care should be taken to prevent water from wet tubes from entering the meter chamber.

NEVER PUT WET TUBES IN THE METER.

### Safety Precautions

---

Read the label on all reagent containers. Some labels include precautionary notices and first aid information. Certain reagents are considered potential health hazards and are designated with a \* in the instruction manual. To view or print a Material Safety Data Sheet (MSDS) for these reagents see MSDS CD or go to [www.lamotte.com](http://www.lamotte.com). To obtain a printed copy, contact LaMotte by e-mail, phone or FAX. Additional information for all LaMotte reagents is available in the United States, Canada, Puerto Rico, and the US Virgin Islands from Chem-Tel by calling 1-800-255-3924. For other areas, call 813-248-0585 collect to contact Chem-Tel's International access number. Each reagent can be identified by the four-digit number listed on the upper left corner of the reagent label, in the content list and in the test procedures.

### Limits of Liability

---

Under no circumstances shall LaMotte Company be liable for loss of life, property, profits, or other damages incurred through the use or misuse of their products.

## Specifications - 2020e and 2020i

---

Instrument Type:	Nephelometer
Standard:	EPA 180.1, 2020e ISO7027, 2020i
Units of Measure & Range:	NTU (Nephelometric Turbidity Units) 0-2000 FNU (Formazin Nephelometric Units) 0-2000 ASBC (American Society of Brewing Chemists) 0-3500 EBC (European Brewery Convention) 0-500 FAU (Formazin Attenuation Unit) 40-4000
Resolution: (display)	0.01 NTU, 0–10.99 NTU Range 0.1 NTU, 11–109.99 NTU Range 1 NTU, 110–4000 NTU Range
Accuracy:	±0.05 or ±2% of reading, whichever is greater, below 100 NTU ±3% of reading, above 100 NTU
Detection Limit:	0.05 NTU
Light Source 2020e:	Tungsten lamp 2300°C ±50 °C
Light Source 2020i:	IR LED 860 nm ±10 nm, spectral bandwidth 50 nm
Detector 2020e:	Photodiode, centered at 90°, maximum peak 550 nm
Detector 2020i:	Photodiode, centered at 90°
Stabilization:	Automatic Light Source
Response Time:	<5 seconds
Sample:	10 mL in capped tube
Software:	Data Logging: 4004 points Auto Shut-off: 5, 10, 30 min, disabled Calibration: Field adjustable, blank & 1 point
Languages:	English, French, Spanish, Japanese (Kana), Portuguese, Italian
Temperature:	Operation: 0–50 °C; Storage: -40–60 °C
Humidity:	Operation: 0–90 % RH, non-condensing
Power Source*:	Battery Operation: 9 volt alkaline Line Operation: Input: 100-240VAC/50-60Hz with imbedded IEC socket (2 pin) Output: 9VDC REG 1.2A with 2.1 x 5.5 mm output plug center positive
Battery Life:	>250 tests, 2020e, >2500 tests, 2020i (with signal averaging disabled)
Dimensions:	(L x Wx H) 8.5 x 16.2 x 6.7 cm; 3.4 x 6.4 x 2.6 inches
Weight:	339 g, 12 oz (meter only)
Serial Interface:	RS232, 8 pin mDIN, 9600b, 8, 1, n

\*CE Mark: The device complies to the product specifications for the Low Voltage Directive when furnished with the 100-240V AC Adapter (Code 1754).



## Statistical and Technical Definitions Related to Product Specifications . . .

**Method Detection Limit (MDL):** “The method detection limit (MDL) is defined as the minimum concentration of a substance that can be measured and reported with 99% confidence that the analyte concentration is greater than zero and is determined from analysis of a sample in a given matrix containing the analyte.”<sup>1</sup> Note that, “As Dr. William Horwitz once stated, ‘In almost all cases when dealing with a limit of detection or limit of determination, the primary purpose of determining that limit is to stay away from it.’”<sup>2</sup>

**Accuracy:** Accuracy is the nearness of a measurement to the accepted or true value.<sup>3</sup> The accuracy can be expressed as a range, about the true value, in which a measurement occurs (i.e.  $\pm 0.5$  ppm). It can also be expressed as the % recovery of a known amount of analyte in a determination of the analyte (i.e. 103.5 %).

**Resolution:** Resolution is the smallest discernible difference between any two measurements that can be made.<sup>4</sup> For meters this is usually how many decimal places are displayed. (i.e. 0.01). Note that the resolution may change with concentration or range. In some cases the resolution may be less than the smallest interval, if it is possible to make a reading that falls between calibration marks. *A word of caution, that resolution has very little relationship to accuracy or precision. The resolution will always be less than the accuracy or precision but it is not a statistical measure of how well a method of analysis works. The resolution can be very, very good and the accuracy and precision can be very bad! This is not a useful measure of the performance of a test method.*

**Repeatability:** Repeatability is the within-run precision.<sup>5</sup> A run is a single data set, from set up to clean up. Generally, one run occurs on one day. However, for meter calibrations, a single calibration is considered a single run or data set, even though it may take 2 or 3 days.

**Reproducibility:** Reproducibility is the between-run precision.<sup>6</sup>

**Detection Limit (DL):** The detection limit (DL) for the 2020 is defined as the minimum value or concentration that can be determined by the meter, which is greater than zero, independent of matrix, glassware, and other sample handling sources of error. It is the detection limit for the optical system of the meter.

<sup>1</sup> CFR 40, part 136, appendix B

<sup>2</sup> Statistics in Analytical Chemistry: Part 7 – A Review, D. Coleman and L Vanatta, American Laboratory, Sept 2003, P. 31.

<sup>3</sup> Skoog, D.A., West, D. M., *Fundamental of Analytical Chemistry*, 2<sup>nd</sup> ed., Holt Rinehart and Winston, Inc, 1969, p. 26.

<sup>4</sup> Statistics in Analytical Chemistry: Part 7 – A Review, D. Coleman and L Vanatta, American Laboratory, Sept 2003, P. 34.

<sup>5</sup> Jeffery G. H., Basset J., Mendham J., Denney R. C., *Vogel’s Textbook of Quantitative Chemical Analysis*, 5<sup>th</sup> ed., Longman Scientific & Technical, 1989, p. 130.

<sup>6</sup> Jeffery G. H., Basset J., Mendham J., Denney R. C., *Vogel’s Textbook of Quantitative Chemical Analysis*, 5<sup>th</sup> ed., Longman Scientific & Technical, 1989, p. 130

## Contents and Accessories

	2020e Kit EPA Version Code 1979-EPA	2020i Kit ISO Version Code 1979-ISO
<b>CONTENTS</b>	Code	Code
0 NTU Standard, 60 mL	1480	1480
1 NTU Standard, 60 mL	1484	1481
10 NTU Standard, 60 mL	1485	1482
Water Sample Bottle, 60 mL	0688	0688
Tubes, 4 (Two with tube positioning rings)	—	—
Battery, 9V	—	—
<b>ACCESSORIES</b>		
1486	100 NTU Standard, 60 mL (EPA)	
1483	100 NTU Standard, 60 mL (ISO)	
0475	Tubes, Code 0290, Set of 6	
0641	Tube Positioning Ring, Pack of 2	
4185	Turbidity-Free Water Kit	
2-2097	Filters, 0.1 micron, Pack of 50	
1772	Interface Cable, RS232	
1754	AC Adapter, 9V (variable 100-240V)	
1912-3 or 1912-CD	SMARTLink 2 Software and Interface Cable	

### EPA Compliance

The 2020e meter meets or exceeds EPA design specifications for NPDWR and NPDES turbidity monitoring programs as specified by the USEPA method 180.1.



### ISO Compliance

This 2020i meter meets or exceeds ISO design criteria for quantitative methods of turbidity using optical turbidimeters as specified by ISO 7027.



### CE Compliance

The 2020e and 2020i meters have been independently tested and have earned the European CE Mark of compliance for electromagnetic compatibility and safety. To view certificates of compliance, see our website [www.lamotte.com](http://www.lamotte.com).



Note: The device complies to the product specifications for the Low Voltage Directive when furnished with the AC Adapter (Code 1754).

### Warranty

The 2020e and 2020i meters are guaranteed to be free of defects in material and workmanship for two years from original purchase date. If within that time the meters are found to be defective, they will be repaired without charge except for transportation costs. The guarantee does not cover batteries.







LaMotte Company • PO Box 329 • 802 Washington Avenue  
Chestertown • Maryland • 21620 • USA

USA 800-344-3100 • 410-778-3100 • fax 410-778-6394 • [www.lamotte.com](http://www.lamotte.com)

Code 1979-MN



## STANDARD OPERATING PROCEDURE

### VOLUNTEER RIVER MONITORING PROGRAM (VRMP)

#### METHODS FOR USING THE IDEXX COLILERT® TEST KIT AND IDEXX QUANTI-TRAY/2000



**Note:** The mention of brand names does not constitute recommendation of a specific company.

## Volunteer River Monitoring Program

### Standard Operating Procedure Methods for Using the IDEXX Colilert® Test Kit and the IDEXX Quanti-Tray/2000 (for use with the IDEXX Quanti-Tray Sealer)

**1. Applicability.** This standard operating procedure (SOP) is used by the Volunteer River Monitoring Program (VRMP) of the Maine Department of Environmental Protection's (DEP's) Bureau of Water Quality, Division of Environmental Assessment, Watershed Management Unit. It applies to the collection of total coliform and *Escherichia coli* (*E. coli*) from rivers and stream in Maine using the IDEXX Colilert Test Kit and the IDEXX Quanti-Tray/2000 (for use with the IDEXX Quanti-Tray Sealer).

**2. Purpose.** The purpose of this SOP is to provide standardized methods for volunteer groups to determine total coliform and *Escherichia coli* of rivers and streams as an instantaneous reading using the IDEXX Colilert Test Kit and the IDEXX Quanti-Tray/2000 (for use with the IDEXX Quanti-Tray Sealer).

#### 3. Definitions

- A. IDEXX.** Manufacturer of technology-based products and services for veterinary, food and water applications including IDEXX Colilert® Test Kit and IDEXX Quanti-Tray/2000.
- B. Total Coliform.** Bacteria that are found in the soil, in water, on vegetation and in human or animal waste.
- C. *Escherichia coli* (*E. coli*).** A type of coliform bacteria that is commonly found in the intestines of animals and humans.

#### 4. Responsibilities

##### A. *Volunteer Monitors & Volunteer Groups*

- **Certification.** It is the responsibility of the individual obtaining this data to maintain current certification for the parameter(s) they collect if they wish their data to be entered into the VRMP database. Training will be provided to volunteers on an annual basis by VRMP/DEP staff, and certification will last for one year from the date of training.
- **Data Recording.** It is the responsibility of the individual obtaining this data to record the results and additional qualifying information on current VRMP field sheets

obtained from their affiliated watershed association or through the VRMP program of the DEP.

- **Data Quality Checks and Data Submission.** The data manager for the volunteer group will collect and enter volunteer field sheet data into the appropriate computer file, perform quality assurance checks (Refer to Section 5.10 of the VRMP's Quality Assurance Project Plan [DEP, 2019]), and submit data to the VRMP following protocols outlined in the volunteer group's latest sampling and analysis plan (SAP) that has been approved by the VRMP.

#### ***B. Volunteer River Monitoring Program (VRMP) Staff***

- **Oversight of Volunteer Groups and Volunteers.** VRMP staff will oversee volunteer groups and volunteers through a variety of ways including maintaining an up-to-date VRMP quality assurance program plan (QAPP); reviewing sampling and analysis plans (SAPs) of the volunteer groups; providing annual training/certification sessions for volunteers; conducting quality assurance checks on data submitted by volunteer groups and laboratories; and uploading data into the DEP's EGAD (Environmental and Geographic Analysis Database) database. These tasks are described in greater detail in the VRMP's latest QAPP.

### **5. Guidelines and procedures**

#### ***A. Safety.***

- Volunteers shall wear gloves and safety glasses while using the reagents. In addition, volunteers shall wash hands after use.

#### ***B. IDEXX Colilert® Test Kit and IDEXX Quanti-Tray/2000 Preparation.***

- **First time use, beginning of field season, and prior to field sampling.** Conduct a full inspection of the kit to ensure completeness and valid chemical expiration dates. Follow manufacturer's instructions for setting up the IDEXX Quanti-Tray Sealer (Appendix C, Section, "Setting Up"). If any problems are detected, contact your group's coordinator or the VRMP for recommendations on how to resolve them.

#### ***C. Total Coliform and E. coli Measurements.***

- **Sampling Period and Location.** Sampling period and site location information will be documented in SAPs (that require approval by the VRMP) that are submitted by the volunteer groups prior to the beginning of a sampling season. Detailed information regarding how volunteer groups are to obtain and document site location information can be found in DEP VRMP SOP-02 [Methods for Selecting and Documenting Site Locations].
- **Measurements.**

- (1) Record site location on data sheet.
  - (2) See DEP VRMP Standard Operating Procedure, “Methods for Collecting Water Grab Samples in Rivers and Streams” (VRMP SOP-01) for proper sampling technique for collecting a water grab sample.
  - (3) Samples shall be stored at  $<10^{\circ}\text{C}$  until analysis. The maximum holding time is 6 hours. Samples must be processed within 2 hr of arriving at laboratory. (Refer to Table 3c of the latest VRMP QAPP [MDEP, 2020]).
- **Sample Preparation Procedure. (For complete instructions refer to Appendix B)**
    - (1) Prepare reagent/sample mixture by adding contents of 1 snap pack to 100 ml of the water sample either in the sample container or in a sterile container (Refer to Appendix A, Section “Quanti-Tray® Enumeration Procedure”).
    - (2) Prepare Quanti-Tray/2000 for reagent/sample mixture (Refer to Appendix B, Section “User Instructions”, Steps #1 – 3).
    - (3) Pour the reagent/sample mixture directly into the Quanti-Tray/2000. Be sure to avoid any contact with the foil tab. Tap the small wells 2-3 times to release any air bubbles. Allow foam to settle.
    - (4) Place the sample-filled Quanti-Tray onto the Quanti-Tray/2000 rubber insert of the Quanti-Tray Sealer with the well side (plastic) of the Quanti-Tray facing down.
  - **Quanti-Tray Sealer Procedure and Incubation.**
    - (1) Follow manufacturer’s instructions for first time use (Refer to Appendix C, Section, “Setting Up”).
    - (2) After the Quanti-Tray has been filled with a sample, seal tray according to manufacturer’s instructions (Refer to Appendix C, Section, “Operating Directions”).
  - **Incubation and Result Analysis**
    - (1) After Quanti-tray has been sealed, place the sealed tray in a  $35^{\circ}\text{C} \pm 0.5^{\circ}\text{C}$  incubator for 24-28 hours.
    - (2) Read results according to the Result Interpretation table found in Appendix A, Section, “Quanti-Tray Enumeration Procedure”.
    - (3) Count the number of positive wells and refer to the Most Probable Number (MPN) table provided with the trays to obtain a MPN. (Refer to Appendix B for IDEXX Quanti-Tray/2000 MPN Table).
    - (4) Autoclave used trays at  $121^{\circ}\text{C}$  for 15-30 minutes at 15 pounds of pressure prior to disposal.
- D. Quality Control.**
- (1) At the beginning of each field season, all VRMP staff and VRMP volunteers who will collect Total Coliform and *E. coli* data will have a training/refresher session to (re)familiarize themselves with the contents of this SOP.



- (2) For every volunteer, a field duplicate shall be obtained for all parameters for at least 10% of their own sampling efforts. A field duplicate will be collected for every 10 samples monitored.
- (3) For each lot of media and trays, conduct a blank and positive test.
- (4) Refer to the VRMP quality assurance project plan (QAPP) for more QA/QC details.

## 6. Equipment Care

### A. *Start of field season.*

1. A full inspection and inventory of the Colilert Test kit including expiration dates of snap packs.

### B. *During field season.*

1. Keep kit out of direct sunlight as much as possible.
2. Store kit indoors in a cool, dry place out of direct sun. Keep out of the reach of children and pets.
3. Keep close track of snap pack expiration dates and replace as necessary.

### C. *End of field season.*

1. Store kit indoors in a cool, dry place out of direct sun. Keep out of the reach of children and pets.

## 7. Appendices

A. *IDEXX Laboratories, Inc. 2007.* Coli-ert® Test Kit Instructions. Westbrook, ME.

B. *IDEXX Laboratories, Inc. 2007.* IDEXX Quanti-Tray/2000, Insert and Most Probable Number (MPN) Table. Westbrook, ME.

C. *IDEXX Laboratories, Inc. 2002.* IDEXX Quanti-Tray Sealer Model 2X User Manual. Westbrook, ME.

## 8. References

### A. *Maine VRMP QAPP:*

- Maine Department of Environmental Protection (MDEP). 2020. Maine Volunteer River Monitoring Program (VRMP) Quality Assurance Program Plan (QAPP). Portland, ME. DEPLW-0984.
- Maine Department of Environmental Protection (MDEP), Maine Volunteer River Monitoring Program (VRMP). 2020. Standard Operating Procedure: Methods for collecting Water Grab Samples in Rivers and Streams. SOP-01. Portland, ME.

## Colilert® Test Kit

**Introduction**

Colilert simultaneously detects total coliforms and *E. coli* in water. It is based on IDEXX's patented Defined Substrate Technology® (DST®). When total coliforms metabolize Colilert's nutrient-indicator, ONPG, the sample turns yellow. When *E. coli* metabolize Colilert's nutrient-indicator, MUG, the sample fluoresces. Colilert can simultaneously detect these bacteria at 1 cfu/100 mL within 24 hours even with as many as 2 million heterotrophic bacteria per 100 mL present.

**Contents**

WP020I contains 20 Snap Packs for 100 mL samples
WP200I contains 200 Snap Packs for 100 mL samples
W050I contains 20 Snap Packs for 50 mL samples
W050BI contains 200 Snap Packs for 50 mL samples

**Storage**

Store at 2°–30° C away from light.

**Presence/Absence (P/A) Procedure**

- Add contents of one pack to a 100 mL sample (50 mL for W050I and W050BI) in a sterile, transparent, nonfluorescing vessel.
- Cap vessel and shake.
- Incubate at 35°C ± 0.5°C for 24 hours.
- Read results according to Result Interpretation table below.

**Quanti-Tray® Enumeration Procedure (WP020I and WP200I only)**

- Add contents of one pack to a 100 mL water sample in a sterile vessel.
- Cap vessel and shake until dissolved.
- Pour sample/reagent mixture into a Quanti-Tray or Quanti-Tray®/2000 and seal in an IDEXX Quanti-Tray® Sealer.
- Place the sealed tray in a 35°C ± 0.5°C incubator for 24 hours.
- Read results according to the Result Interpretation table below. Count the number of positive wells and refer to the MPN table provided with the trays to obtain a Most Probable Number.

**Result Interpretation**

Appearance	Result
Less yellow than the comparator*	Negative for total coliforms and <i>E. coli</i>
Yellow equal to or greater than the comparator*	Positive for total coliforms
Yellow and fluorescence equal to or greater than the comparator*	Positive for <i>E. coli</i>

- Look for fluorescence with a 6-watt, 365-nm UV light within 5 inches of the sample in a dark environment. Face light away from your eyes and towards the sample.
- Colilert results are definitive at 24–28 hours. In addition, positives for both total coliforms and *E. coli* observed before 24 hours and negatives observed after 28 hours are also valid.

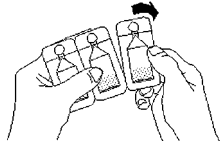
**Procedural Notes**

- This insert may not reflect your local regulations. For compliance testing, be sure to follow appropriate regulatory procedures.
- Colilert can be run in any multiple tube format. *Standard Methods for the Examination of Water and Wastewater*\*\* MPN tables should be used to find Most Probable Numbers (MPNs).
- If a water sample has some background color, compare inoculated Colilert sample to a control blank of the same water sample.
- If sample dilutions are made, multiply the MPN value by the dilution factor to obtain the proper quantitative result.
- Use only sterile, nonbuffered, oxidant-free water for dilutions.
- Colilert is a primary water test. Colilert performance characteristics do not apply to samples altered by any pre-enrichment or concentration.
- In samples with excessive chlorine, a blue flash may be seen when adding Colilert. If this is seen, consider sample invalid and discontinue testing.
- Aseptic technique should always be followed when using Colilert. Dispose of in accordance with Good Laboratory Practices.

**Quality Control Procedures**

The following quality control procedure is recommended for each lot of Colilert:

- Inoculate 3 sterile vessels filled with 100 mL sterile water with the following:
  - one with Quanti-Cult™\*\*\* *E. coli* or a sterile loop of ATCC\*\*\*\* 25922 or 11775 (*E. coli*)
  - one with Quanti-Cult *Klebsiella pneumoniae* or a sterile loop of ATCC 31488 (total coliform)
  - one with Quanti-Cult *Pseudomonas aeruginosa* or a sterile loop of ATCC 10145 or 27853 (noncoliform)
- Follow the P/A Procedure or Quanti-Tray Enumeration Procedure above.
- Results should match the Result Interpretation table above.



## Trousse d’analyse Colilert®

**Introduction**

Colilert permet la détection simultanée des coliformes totaux et *E. coli* dans l’eau. Ce test est basé sur la technologie brevetée Defined Substrate Technology® (DST®) d’IDEXX. Lorsque les coliformes totaux métabolisent ONPG, l’indicateur de nutriants Colilert, le prélèvement vire au jaune. Lorsque *E. coli* métabolise MUG, l’indicateur de nutriants Colilert, le prélèvement devient fluorescent. Colilert peut détecter simultanément ces bactéries à 1 cfu/100 ml en 24 heures, même en présence de bactéries hétérotrophes d’une concentration de 2 millions par 100 ml.

**Contenu**

WP020I contient 20 sachets hermétiques pour prélèvements de 100 ml
WP0200I contient 200 sachets hermétiques pour prélèvements de 100 ml
W050I contient 20 sachets hermétiques pour prélèvements de 50 ml
W050BI contient 200 sachets hermétiques pour prélèvements de 50 ml

**Conditions de Conservation**

Conserver entre 2° et 30°C à l’abri de la lumière.

**Procédure de Présence/Absence (P/A)**

- Ajouter le contenu d’un sachet dans un prélèvement de 100 ml (50 ml dans le cas du W050I et du W050BI) placé dans un récipient stérile, transparent et non fluorescent.
- Fermer le récipient et agiter.
- Incuber à 35°C ± 0,5°C pendant les 24 heures qui suivent.
- Interpréter les résultats en se référant au tableau d’interprétation des résultats ci-dessous.

**Quanti-Tray® Procédure de numération (WP020I et WP200I uniquement)**

- Ajouter le contenu d’un sachet dans un prélèvement de 100 ml d’eau placé dans un récipient stérile.
- Fermer le récipient et agiter jusqu’à dissolution.
- Verser le mélange prélèvement/réactif dans un Quanti-Tray ou un Quanti-Tray/2000 et fermer hermétiquement dans un dispositif hermétique Quanti-Tray IDEXX.
- Placer le plateau hermétiquement fermé dans un incubateur à 35°C ± 0,5°C pendant 24 heures.
- Interpréter les résultats en se référant au tableau d’interprétation des résultats ci-dessous. Compter le nombre de puits positifs et se référer au tableau MPN fourni avec les plateaux pour obtenir le Chiffre le plus probable (MPN).

**Interprétation des Résultats**

Aspect	Résultat
Moins jaune que le comparateur*	Négatif pour les coliformes totaux et <i>E. coli</i>
Aussi jaune ou plus jaune que le comparateur*	Positif pour les coliformes totaux
Couleur jaune et fluorescence égales ou supérieures au comparateur*	Positif pour <i>E. coli</i>

Colilert

- Évaluer la fluorescence avec une ampoule UV de 6 watts et 365 nm placée à 13 cm du prélèvement dans l’obscurité. Orienter la lumière vers le prélèvement, dans la direction opposée à celle des yeux de l’opérateur.
- Les résultats de Colilert doivent être lus entre 24 et 28 heures. En outre, les résultats positifs pour les coliformes totaux et *E. coli* notés avant 24 heures, de même que les résultats négatifs notés après 28 heures sont également valides.

**Remarques Concernant la Procédure**

- Cette notice peut différer des réglementations en vigueur dans votre pays. Pour tout test de conformité, suivre les procédures réglementaires appropriées.
- Colilert peut être effectuée en format de tubes multiples. Utiliser des méthodes standards et les tableaux MPN pour le contrôle des eaux et eaux usées\*\* afin de déterminer les Chiffres les Plus Probables (MPN).
- Si un prélèvement d’eau présente une couleur de fond, comparer le prélèvement inoculé avec Colilert à un contrôle neutre du même prélèvement d’eau.
- Si les prélèvements sont dilués, multiplier la valeur MPN par le facteur de dilution pour obtenir le résultat quantitatif correct.
- Utiliser uniquement de l’eau stérile, non tamponnée et sans oxydant pour les dilutions.
- Colilert est avant tout un test pour eau. Les caractéristiques de performance de Colilert ne s’appliquent pas aux prélèvements altérés par tout enrichissement préalable ou toute concentration.
- Avec les prélèvements présentant un excédent de chlore, il peut se produire une rapide lueur bleuâtre lors de l’ajout de Colilert. Si tel est le cas, le prélèvement n’est pas valide et il faut cesser le test.
- Utiliser systématiquement des techniques aseptiques dans l’emploi de Colilert. Mettre au rebut conformément aux Bonnes pratiques de laboratoire.

**Procédures de contrôle de qualité**

Il est recommandé d’adopter la procédure de contrôle de qualité suivante pour chaque lot de Colilert :

- Inoculer 3 récipients stériles remplis de 100 ml d’eau stérile comme suit:
  - un avec Quanti-Cult™ \*\*\* *E. coli* ou une boucle stérile d’ATCC\*\*\*\* 25922 ou 11775 (*E. coli*)
  - un avec *Klebsiella pneumoniae* Quanti-Cult ou une boucle stérile d’ATCC 31488 (coliformes totaux)
  - un avec *Pseudomonas aeruginosa* Quanti-Cult ou une boucle stérile d’ATCC 10145 ou 27853 (non coliforme)
- Suivre la procédure P/A ou la procédure de numération Quanti-Tray ci-dessus.
- Les résultats doivent correspondre aux résultats du tableau d’interprétation ci-dessus.

Colilert

\*Comparateur P/A IDEXX, réf. n° WP104· Comparateur Quanti-Tray n° WQTC ou Quanti-Tray/2000 Comparateur n° WQ2KC

\*\*Eaton AD, Clesceri LS, Greenberg AE. Standard Methods for the Examination of Water and Wastewater, American Public Health Association, 1998, Washington, DC.

© 2007 IDEXX Laboratories, Inc. Tous droits réservés. Manufacturé sous un ou plusieurs du suivant brevets U.S. nos 4,925,789; 5,429,933; 5,518,892; 5,610,029; 5,620, 865; 5,620,895; 5,753,456 et 5,780,259. Autres brevets américains et/ou étrangers enregistrés ou en cours d’enregistrement.

## Kit di analisi Colilert®

**Introduzione**

Colilert rileva simultaneamente i coliformi totali e l’*E. coli* nell’acqua. Si basa su una tecnologia di substrato definito (Defined Substrate Technology) brevettata IDEXX® (DST®). Quando i coliformi totali metabolizzano l’indicatore di nutrienti del Colilert, ONPG, il campione diventa giallo. Quando l’*E. coli* metabolizza l’indicatore di nutrienti del Colilert, MUG, il campione diventa fluorescente. Il Colilert è in grado di rilevare simultaneamente questi batteri in concentrazioni di 1 cfu/100 ml entro 24 ore anche se sono presenti addirittura 2 milioni di batteri eterotrofici per 100 ml.

**Contenuto**

WP020I contiene 20 pacchetti Snap per campioni da 100 ml
WP200I contiene 200 pacchetti Snap per campioni da 100 ml
W050I contiene 20 pacchetti Snap per campioni da 50 ml
W050BI contiene 200 pacchetti Snap per campioni da 50 ml

**Conservazione**

Conservare a 2°–30°C lontano dalla luce.

**Procedura Relativa a Presenza/Assenza (P/A)**

- Unire il contenuto di un pacchetto ad un campione da 100 ml (50 ml per W050 e W050B) in un a provetta sterile, trasparente e non fluorescente.
- Incappucciare la provetta ed agitarla.
- Incubare a 35°C ± 0,5°C per 24 ore.
- Leggere i risultati secondo la tabella di Interpretazione dei risultati qui sotto.

**Procedura di Enumerazione Quanti-Tray® (solo WP020I e WP200I)**

- Unire il contenuto di un pacchetto ad un campione di acqua da 100 ml in una provetta sterile.
- Chiudere la provetta e agitarla fino a dissoluzione.
- Versare la miscela campione/reagente in un vassoietto Quanti-Tray o Quanti-Tray/2000 e sigillarlo in un Sigillatore Quanti-Tray IDEXX.
- Mettere il vassoietto sigillato in un’incubatrice a 35°C ± 0,5°C per 24 ore.
- Leggere i risultati secondo la tabella di Interpretazione dei risultati qui sotto. Contare il numero di pozzetti positivi e consultare la tabella MPN fornita insieme ai vassoietti per ottenere il numero più probabile.

**Interpretazione dei Risultati**

Aspetto	Risultato
Meno giallo rispetto al colore di confronto*	Negativo per coliformi totali ed <i>E. coli</i>
Giallo uguale o più intenso rispetto al colore di confronto*	Positivo per coliformi totali
Giallo e fluorescenza uguali o più intensi rispetto al colore di confronto*	Positivo per <i>E. coli</i>

Colilert

- Individuare la fluorescenza con una luce a raggi ultravioletti da 6 watt, 365 nm, entro circa 13 cm dal campione, in ambiente buio. Dirigere la luce verso il campione, in direzione opposta ai propri occhi.
- I risultati del Colilert sono definitivi a 24-28 ore. Inoltre, i risultati positivi sia per i coliformi totali che per l’*E. coli* osservati prima di 24 ore ed i risultati negativi osservati dopo 28 ore sono anch’essi validi.

**Note Sulla Procedura**

- Questo inserto informativo potrebbe non riflettere le normative locali. Per i test sulla conformità, assicurarsi di seguire le procedure normative corrispondenti.
- Il Colilert si può eseguire in qualsiasi formato a provetta multipla. I metodi standard per l’esame delle tabelle MPN dell’acqua e delle acque di scarico\*\* vanno usati per ottenere i Numeri Più Probabili (MPN).
- Se un campione di acqua dovesse presentare della colorazione di sfondo, confrontare il campione Colilert inoculato con controllo vuoto dello stesso campione di acqua.
- Se il prodotto viene diluito, moltiplicare il valore MPN per il fattore di diluizione per ottenere la quantità giusta.
- Per le diluizioni usare solo acqua sterile, non tamponata, priva di ossidanti.
- Il Colilert è un test primario per l’acqua. Le caratteristiche di prestazione del Colilert non sono applicabili a campioni alterati da qualsiasi pre-arricchimento o da concentrazione.
- In campioni con cloro eccessivo, quando si aggiunge il Colilert si potrebbe vedere un lampo azzurro. In questo caso, considerare il campione non valido e interrompere l’analisi.
- Quando si usa il Colilert va sempre seguita la tecnica asettica. Eliminare secondo le buone pratiche di laboratorio.

**Procedure di Controllo della Qualità**

Si raccomanda la seguente procedura di controllo della qualità per ogni lotto di Colilert:

- Inoculare con quanto segue 3 provette sterili contenenti 100 ml di acqua sterile:
  - una con Quanti-Cult™\*\*\* *E. coli* o un’ansa sterile di ATCC\*\*\*\* 25922 o 11775 (*E. coli*)
  - una con Quanti-Cult *Klebsiella pneumoniae* o un’ansa sterile di ATCC 31488 (coliformi totali)
  - una con Quanti-Cult *Pseudomonas aeruginosa* o un’ansa sterile di ATCC 10145 o 27853 (non-coliforme)
- Seguire la procedura P/A o la procedura di enumerazione Quanti-Tray descritte sopra.
- I risultati devono corrispondere a quelli della tabella di Interpretazione dei risultati indicata sopra.

Colilert

\*Comparatore P/A IDEXX, codice di catalogo WP104; Comparatore Quanti-Tray N. WQTC o Quanti-Tray/2000 Comparatore N. WQ2KC

\*\*Eaton AD, Clesceri LS, Greenberg AE. Standard Methods for the Examination of Water and Wastewater, American Public Health Association, 1998, Washington, DC.

© 2007 IDEXX Laboratories, Inc. Tutti i diritti riservati. Prodotto sotto uno o più di seguenti brevetti USA n. 4,925,789; 5,429,933; 5,518,892; 5,610,029; 5,620, 865; 5,620,895; 5,753,456 e 5,780,259. Altri brevetti degli U.S.A. e/o stranieri concessi o domade di brevetto degli U.S.A. e/o stranieri pendenti.

## Colilert® Testkit

**Einführung**

Colilert ist zum gleichzeitigen Nachweis von Gesamtcoliformen und *E. coli* im Wasser bestimmt. Es basiert auf der patentierten Defined Substrate Technology® (DST®) von IDEXX. Wenn die Gesamtcoliformen den Nährstoff-Indikator ONPG von Colilert metabolisieren, verfärbt sich die Probe gelb. Wenn *E. coli* den Nährstoff-Indikator MUG von Colilert metabolisieren, fluoresziert die Probe. Colilert kann diese Bakterien gleichzeitig im Bereich von 1 CFU/100 ml innerhalb von 24 Stunden nachweisen, selbst wenn 2 Mio. heterotrophe Bakterien pro 100 ml vorhanden sind.

**Inhalt**

WP020I enthält 20 Snap Packs für 100 ml Proben
WP200I enthält 200 Snap Packs für 100 ml Proben
W050I enthält 20 Snap Packs für 50 ml Proben
W050BI enthält 200 Snap Packs für 50 ml Proben

**Lagerung**

Bei 2°–30°C und nicht im Licht lagern.

**Presence/Absence (P/A) Test**

- Den Inhalt einer Packung zu einer 100 ml Probe (50 ml für W050I und W050BI) in einem sterilen, transparenten, nicht fluoreszierenden Gefäß hinzugeben.
- Das Gefäß verschließen und schütteln.
- Für den verbleibenden 24-Stunden-Zeitraum bei 35°C ± 0,5°C inkubieren.
- Die Ergebnisse gemäß der nachstehenden Ergebnisauswerte-Tabelle ablesen.

**Quanti-Tray® Auszähl-Methode (nur WP020I und WP200I)**

- Den Inhalt einer Packung zu einer 100 ml Wasserprobe in einem sterilen Gefäß hinzugeben.
- Das verschlossene Tray 24 Stunden in einen Inkubator im Temperaturbereich von 35°C ± 0,5°C stellen.
- Die Ergebnisse anhand der nachstehenden Ergebnisauswerte-Tabelle ablesen. Die Anzahl der positiven Vertiefungen zählen und die wahrscheinlichste Zahl (MPN; Most Probable Number) anhand der MPN-Tabelle, die den Trays beiliegt, ermitteln.

**Ergebnisauswertung**

Aussehen der Probe	Mögliche Ergebnisse
Geringere Gelbfärbung als der Comparator *	Negativ für Gesamtcoliforme und <i>E. coli</i>
Gleiche oder stärkere Gelbfärbung als der Comparator *	Positiv für Gesamtcoliforme
Gelbfärbung und Fluoreszenz gleich oder stärker als die des Comparators *	Positiv für <i>E. coli</i>

Colilert

- Prüfung auf Fluoreszenz mit einer 6-Watt, 365 nm UV-Lampe aus einem Abstand von 13 cm in einer dunklen Umgebung. Dabei die Lampe nur auf die Probe, nicht auf die Augen, richten.
- Colilert Ergebnisse sind nach 24–28 Stunden definitiv. Außerdem sind positive Ergebnisse für Gesamtcoliforme und *E. coli*, die vor Ablauf von 24 Stunden beobachtet werden, und negative Ergebnisse, die nach 28 Stunden beobachtet werden, gültig.

**Verfahrenshinweise**

- Diese Packungsbeilage gibt möglicherweise nicht Ihre örtlichen Vorschriften wieder. Bei den Qualitätstests sind die anwendbaren aufsichtsbehördlichen Verfahren zu befolgen.
- Das Colilert Verfahren kann in jedem Multiple-Tube-Format durchgeführt werden. Zur Ermittlung der MPNs (wahrscheinlichste Zahlen) sollten MPN-Tabellen für Standardverfahren zur Untersuchung von Wasser und Abwasser\*\* verwendet werden.
- Wenn eine Wasserprobe etwas Hintergrundfarbe aufweist, ist die inokulierte Colilert Probe mit einer Kontrollprobe derselben Wasserprobe zu vergleichen.
- Bei Probenverdünnungen den MPN-Wert mit dem Verdünnungsfaktor multiplizieren, um das korrekte quantitative Ergebnis zu erhalten.
- Nur steriles, nicht gepuffertes, keine Oxidantien enthaltendes Wasser zur Verdünnung verwenden.
- Colilert ist ein primärer Wassertest. Die Leistungsmerkmale von Colilert gelten nicht für Proben, die durch Voranreicherung oder Konzentration modifiziert wurden.
- In Proben mit übermäßigem Chlorgehalt wird bei der Zugabe von Colilert u.U. ein blaues Aufleuchten beobachtet. In diesem Fall ist die Probe als ungültig zu betrachten und der Test abzubrechen.
- Bei der Verwendung von Colilert ist ein aseptisches Vorgehen vorgeschrieben. Entsorgung gemäß Standard-Laborpraktiken.

**Qualitätskontrollverfahren**

Das folgende Qualitätskontrollverfahren wird für jedes Colilert Los empfohlen:

- Drei sterile, mit 100 ml sterilem Wasser gefüllte Gefäße folgendermaßen inokulieren:
  - ein Gefäß mit Quanti-Cult™\*\*\* *E. coli* oder sterile Probenschleife mit ATCC\*\*\*\* 25922 oder 11775 (*E. coli*)
  - ein Gefäß mit Quanti-Cult *Klebsiella pneumoniae* oder eine sterile Probenschleife mit ATCC 31488 (Gesamtcoliform)
  - ein Gefäß mit Quanti-Cult *Pseudomonas aeruginosa* oder eine sterile Probenschleife mit ATCC 10145 oder 27853 (Nichtcoliform)
- Das oben beschriebene P/A-Verfahren oder das Quanti-Tray Auszählverfahren befolgen.
- Die Ergebnisse sollten mit der Ergebnisauswerte-Tabelle oben übereinstimmen.

\*IDEXX P/A Comparator, Best.-Nr. WP104; Quanti-Tray Comparator WQTC oder Quanti-Tray/2000 Comparator WQ2KC

\*\*Eaton AD, Clesceri LS, Greenberg AE. Standard Methods for the Examination of Water and Wastewater (Standardverfahren zur Untersuchung von Wasser und Abwasser), American Public Health Association, 1998, Washington, DC.

\*\*\*American Type Culture Collection 1-800-638-6597

Colilert, Defined Substrate Technology, DST und Quanti-Tray sind Schutzmarken oder eingetragene Schutzmarken von IDEXX Laboratories, Inc. in den Vereinigten Staaten und/oder anderen in Ländern. Quanti-Cult ist ein Warenzeichen von Remel Inc. © 2007 IDEXX Laboratories, Inc. Alle Rechte vorbehalten. Hergestellt unter einem oder mehr der folgenden US-Patente 4,925,789; 5,429,933; 5,518,892; 5,610,029; 5,620, 865; 5,620,895; 5,753,456 und 5,780,259. Andere U.S. und/oder ausländische Patente erteilt oder angemeldet.

<sup>[</sup>\*IDEXX P/A Comparator, catalog #WP104; Quanti-Tray Comparator #WQTC, or Quanti-Tray/2000 Comparator #WQ2KC

<sup>[</sup>\*\* Eaton AD, Clesceri LS, Greenberg AE. Standard Methods for the Examination of Water and Wastewater, American Public Health Association, 1998, Washington, DC.

<sup>[</sup>\*\*\* Quanti-Cult cultures – IDEXX catalog # WKIT-1001

<sup>[</sup>\*\*\*\* American Type Culture Collection 1-800-638-6597

## Colilert® Kit para Prueba

**Introducción**

Colilert detecta simultáneamente los coliformes totales y *E. coli* en el agua. Se basa en Defined Substrate Technology® (Tecnología de sustrato definido [DST®]), patentada por IDEXX. Cuando los coliformes totales metabolizan el indicador ONPG de nutrientes de Colilert, la muestra toma una coloración amarilla. Cuando *E. coli* metaboliza el indicador MUG de nutrientes de Colilert, la muestra fluoresce. Colilert puede detectar simultáneamente estas bacterias a una concentración de 1 ufc/100 ml dentro de las 24 horas, hasta en presencia de 2 millones de bacterias heterotróficas por cada 100 ml.

**Índice**

WP020I contiene 20 paquetes Snap para muestras de 100 ml
WP200I contiene 200 paquetes Snap para muestras de 100 ml
W050I contiene 20 paquetes Snap para muestras de 50 ml
W050BI contiene 200 paquetes Snap para muestras de 50 ml

**Almacenamiento**

Almacenar a temperatura de 2° a 30°C, alejado de la luz.

**Procedimiento de Presencia/Ausencia (P/A)**

- Añadir el contenido de un paquete a una muestra de 100 ml (50 ml para W050I y W050BI) en un recipiente estéril transparente, no fluorescente.
- Tapar y agitar el recipiente.
- Incubar a 35 °C ± 0,5 °C durante 24 horas.
- Leer los resultados de acuerdo con el cuadro de interpretación de resultados, más abajo.

**Procedimiento de Enumeración Quanti-Tray® (WP020I y WP200I solamente)**

- Añadir el contenido de un paquete a una muestra de 100 ml de agua, en un recipiente estéril.
- Tapar y agitar el recipiente hasta disolver.
- Verter la mezcla de muestra/reactivo en una Quanti-Tray o una Quanti-Tray/2000 y sellar en un sellador de Quanti-Tray de IDEXX.
- Colocar la bandeja sellada en una incubadora a 35 °C ± 0,5 °C durante 24 horas.
- Leer los resultados de acuerdo con el cuadro de interpretación de resultados, más abajo. Contar el número de pocillos positivos y referirse al cuadro MPN proporcionado con las bandejas para obtener el número más probable.

**Interpretación de resultados**

Aspecto	Resultado
Menos amarillo que el comparador*	Negativo para coliformes totales y <i>E. coli</i>
Amarillo igual o mayor que el del comparador*	Positivo para coliformes totales
Amarillo y fluorescencia iguales o mayores que los del comparador*	Positivo para <i>E. coli</i>

- Buscar fluorescencia usando una luz UV de 6 vatios, 365 nm a distancia de unas 5 pulgadas (13 cm) de la muestra, en un entorno oscuro. Apuntar el haz de luz en dirección contraria a los ojos y hacia la muestra.
- Los resultados Colilert son definitivos a las 24 a 28 horas. Además, los positivos para coliformes totales y para *E. coli* observados antes de las 24 horas y los negativos observados después de las 28 horas también son válidos.

**Notas sobre el procedimiento**

- Este prospecto tal vez no refleje sus reglamentaciones locales. Para probar el cumplimiento, asegurarse de seguir los procedimientos reglamentarios apropiados.
- Colilert puede procesarse en cualquier formato de múltiples tubos. Deben usarse los Métodos estándares para examen del agua y los cuadros MPN de aguas residuales\*\* para encontrar los números más probables (MPN).
- Si la muestra de agua tiene un cierto color de fondo, comparar la muestra inculada de Colilert con un blanco testigo de la misma muestra de agua.
- Si se hacen diluciones de muestra, multiplicar el valor MPN por el factor de dilución para obtener el resultado cuantitativo apropiado.
- Usar solamente agua estéril, no tamponada, libre de oxidantes, para efectuar las diluciones.
- Colilert es una prueba primaria del agua. Las características de rendimiento de Colilert no se aplican a muestras alteradas por enriquecimiento o concentración previos.
- En el caso de muestras con un exceso de cloro, tal vez se observe un destello azul al añadir Colilert. Si se observa, considerar que la muestra no es válida y suspender la prueba.
- Siempre debe utilizarse una técnica aséptica cuando se use Colilert. Desechar en cumplimiento con las Buenas Prácticas de Laboratorio.

**Procedimientos de control de calidad**

Se recomienda el siguiente procedimiento de control de calidad para cada lote de Colilert:

- Inocular 3 recipientes estériles cargados con 100 ml de agua estéril, con lo siguiente:
  - uno con Quanti-Cult™ \*\*\*de *E. coli* o con un asa estéril de ATCC\*\*\*\* 25922 ó 11775 (*E. coli*)
  - uno con Quanti-Cult de *Klebsiella pneumoniae* o con un asa estéril de ATCC 31488 (coliforme total)
  - uno con Quanti-Cult de *Pseudomonas aeruginosa* o con un asa estéril de ATCC 10145 ó 27853 (no coliforme)
- Seguir el procedimiento P/A o el procedimiento de enumeración Quanti-Tray mencionado anteriormente.
- Los resultados deben corresponder a los del Cuadro de Interpretación de resultados, más arriba.

<sup>[1]</sup> IDEXX, Comparador P/A, N° de catálogo WP104; Comparador Quanti-Tray N° WQTC o Quanti-Tray/2000 Comparador N° WQT2KC
\*\* Eaton AD, Clesceri LS, Greenberg AE. Standard Methods for the Examination of Water and Wastewater (Métodos estándar para el examen de agua y aguas residuales). American Public Health Association, 1998, Washington, DC.
\*\*\* Cultivos Quanti-Cult™ - N° de catálogo IDEXX WKIT-1001
\*\*\*\* American Type Culture Collection 1-800-638-6597

Colilert, Defined Substrate Technology, DST y Quanti-Tray son marcas o marcas registradas de IDEXX Laboratories, Inc. en los Estados Unidos de America y/o en otros países. Quanti-Cult es una marca comercial de Remel Inc.
© 2007 IDEXX Laboratories, Inc. Todos los derechos reservados.
Fabricado bajo una o más de las patentes siguientes de los E.U. 4,925,789; 5,429,933; 5,518,892; 5,610,029; 5,620, 865; 5,620,895; 5,753,456 y 5,780,259. Otras patentes norteamericanas y/o extranjeras concedidas o pendientes de concesión.

## Colilert® コリラート

はじめに

Colilertは、水中の大腸菌群と大腸菌を同時に検出します。 検出方法はIDEXXが特許を取得したDefined Substrate Technology® (DST®)（特定酵素基質法）に基づいています。大腸菌群がColilertの発色酵素基質ONPGを代謝すると、検体は黄変します。大腸菌がColilertの発色酵素基質MUGを代謝すると、検体は蛍光を発します。 Colilertはたとえ100mlあたり最大200万の従属栄養菌が存在したとしても、24時間以内に、1cfu/100mlの感度で大腸菌群および大腸菌を同時に検出することができます。

**内容**

WP020Iは、検体100ml用のスナップバック20個入りです
WP200I は、検体100ml用のスナップバック200個入りです

**保管**

直射日光を避け、2～30°Cで保管してください。

**定性法(P/A)の手順**

- 1バックの中身を、滅菌済みの透明な蛍光を発しない容器の中に入った100mlの検体に加えください。
- 容器の蓋を締め、ゆっくり振ってください。
- 36°Cで、24時間培養してください。
- 以下の結果判定表に従って、結果判定してください。

**Quanti-Tray®QTTレイの計算手順**

- 1バックの中身を、滅菌ベッセルの中に入った100mlの検水に加えてください。
- 容器の蓋を閉め溶けるまで静かに振ってください。
- Quanti-TrayまたはQuanti-Tray/2000に検水/Colilert混合液を注ぎ、シーラーの中で密封してください。
- 密封されたトレイを36°Cの培養器の中に24時間置いてください。
- 以下の結果判定表に従って、結果を判定してください。 陽性ウェルの数を数え、専用MPN表を参照して、最確数を求めてください。

**結果判定**

培養液の状態	結果
比色管*より薄い黄色*	大腸菌群および大腸菌陰性
比色管*と同様か、またはそれ以上の黄色*	大腸菌群陽性
比色管*と同様か、またはそれ以上の黄色および蛍光*	大腸菌陽性

Colilertは、水中の大腸菌群と大腸菌を同時に検出します。 検出方法はIDEXXが特許を取得したDefined Substrate Technology® (DST®)（特定酵素基質法）に基づいています。大腸菌群がColilertの発色酵素基質ONPGを代謝すると、検体は黄変します。大腸菌がColilertの発色酵素基質MUGを代謝すると、検体は蛍光を発します。 Colilertはたとえ100mlあたり最大200万の従属栄養菌が存在したとしても、24時間以内に、1cfu/100mlの感度で大腸菌群および大腸菌を同時に検出することができます。

- 暗所で、検体の5インチ（12.7cm）以内で6W・365 nmのUVランプを使用して、判定してください。 光は、目に向けないようにし、検体に向けてください。
- Colilertの結果は、24～28時間で判定できます。 また、培養24時間以内で大腸菌群及び大腸菌が共に陽性となった場合、陽性判定が有効となり、培養を28時間以上行った場合に共に陰性となった場合は、陰性判定が有効です。

**操作上の注意**

- 全ての国や地方の法律・条令に適合していません。法律・条令に準拠したテストをするために、適切な規定の手順に必ず従ってください。
- Colilertは、5本法などの最確数法でも実施できます。 *MPN*表は、最確数 (*MPN*)を求めるために使用してください。
- 検水に何らかの着色がある場合、同じ検水を用いたブランクと比較してください。
- 検体を希釈した場合、MPN値に希釈倍数を掛けて、適切な定量結果を求めてください。
- 希釈には、緩衝液や酸化物質の入っていない、滅菌された水だけを使用してください。
- Colilertは、水の一次検査です。 Colilertの性能特性として、増菌培地で培養または濃縮によって変質した検体に適用できません。
- Colilertを加えるとき、過剰の塩素がある検体で、青色を呈する場合があります。 これが見られる場合、検体はテストに適さないので、テストを中止してください。
- Colilertを使用する際は、常に無菌操作を行ってください。 GLPIに従って、廃棄してください。

**品質管理手順**

以下の品質管理は、Colilertの各ロットについて行うことをお勧めします。:

- 100mlの滅菌水の入った3つの滅菌容器に以下の菌を接種してください:
  - Quanti-Cult™\*\*\*\* 大腸菌、またはATCC\*\*\*\* 25922または11775
  - Quanti-Cult *Klebsiella pneumoniae*、またはATCC 31488 (大腸菌群)
  - Quanti-Cult *Pseudomonas aeruginosa*、またはATCC 10145または27853
- 上記の定性法 (P/A) 手順またはQuanti-Tray定量法手順に従ってください。
- 結果は上の結果解釈表と一致するはずです。

\*IDEXX P/A 比色管, カタログ # WP104, QTTレイ比色トレイ #WQTC,または QT-Tレイ/2000比色トレイ#WQT2KC
\*\* Eaton AD, Clesceri LS, Greenberg AE. Standard Methods for the Examination of Water and Wastewater. American Public Health Association, 1998, Washington, DC.
\*\*\* Quanti-Cult™ - IDEXX カタログ # WKIT-1001
\*\*\*\*American Type Culture Collection 1-800-638-6597

Colilert Defined Substrate Technology, DST, およびQuanti-Trayは、米国IDEXX及び/または他国のIDEXX Laboratories, Inc.の商標または登録商標です。 Quanti-Cult は、Remel Inc.の商標です。

© 2007 IDEXX Laboratories, Inc. 全著作権所有
4,925,789; 5,429,933; 5,518,892; 5,610,029; 5,620, 865; 5,620,895; 5,753,456および5,780,259. 他の米国および/または外国の発行された特許または出願中の特許。

# Colilert®



06-12999-03

**IDEXX**

www.idexx.com/water

IDEXX Laboratories, Inc., One IDEXX Drive, Westbrook, Maine 04092 USA

**IDEXX**

Australia: 1 800 655 978

Japan: + 81 422 71 5921

China: + 86-21-61279528

UK: + 44 (0) 1638 676800

Europe: 00800 4399 9111

North/South America: 1-207-556-4496/1-800-321-0207

**For Technical Support, please call:**

# IDEXX **Quanti-Tray**

Insert and Most Probable Number (MPN) Table



## **Quanti-Tray Certificate of Sterility**

This certifies that the enclosed Quanti-Trays have been sterilized with ethylene oxide.

For further information or documentation, contact IDEXX Laboratories, Inc.

North/South America: 1-207-556-4496/1-800-321-0207

Europe: 00800 4339 9111

UK: +44 (0) 1638 676800

China: +86-21-61279528

Japan: +81 422 71 5921

Australia: 1800 655 978

**IDEXX**

IDEXX Laboratories, Inc.  
One IDEXX Drive  
Westbrook, Maine 04092 USA



# IDEXX Quanti-Tray

English Version

## Introduction

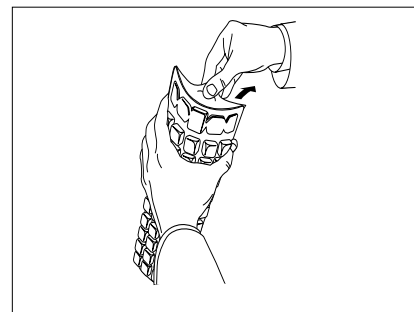
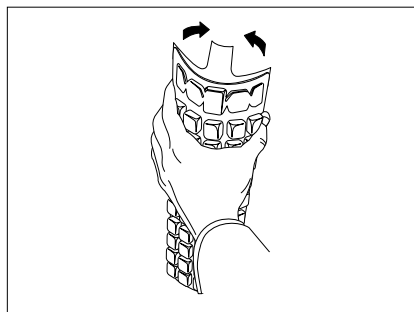
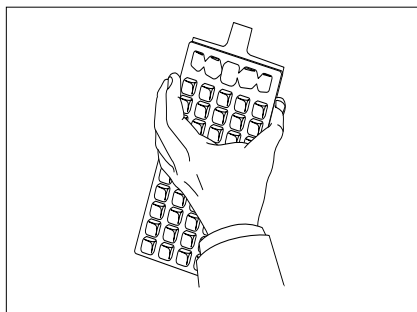
IDEXX Quanti-Trays are designed to give quantitated bacterial counts of 100 mL samples using IDEXX Defined Substrate Technology reagent products. Add the reagent/sample mixture to a Quanti-Tray, seal it in a Quanti-Tray Sealer and incubate per the reagent instructions. Then count the number of positive wells and use the Most Probable Number (MPN) Table attached to determine the MPN.

## Contents

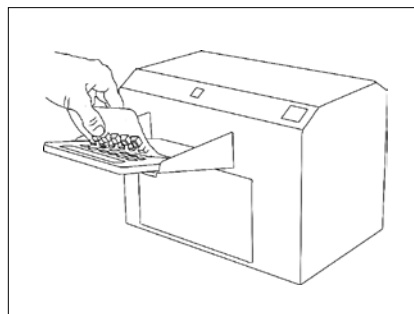
This package contains sterile 51-well Quanti-Trays.

## User Instructions

1. Use one hand to hold a Quanti-Tray upright with the well side facing the palm.
2. Squeeze the upper part of the Quanti-Tray so that the Quanti-Tray bends toward the palm.
3. Open the Quanti-Tray by pulling the foil tab away from the well side. Avoid touching the inside of the foil or tray.



4. Pour the reagent/sample mixture directly into the Quanti-Tray, avoiding contact with the foil tab. Allow foam to settle.
5. Place the sample-filled Quanti-Tray onto the rubber tray carrier of the Quanti-Tray Sealer with the well side (plastic) of the Quanti-Tray facing down to fit into the carrier.



6. Seal according to the Quanti-Tray Sealer instructions.
7. Incubate according to reagent instructions.
8. Count positive wells and refer to the MPN table on the back of this instruction sheet to find the MPN.
9. Dispose of media in accordance with good laboratory practices.

**For Technical Assistance**  
**U.S./Canada 1-800-321-0207 or 1-207-556-4496**  
**[www.idexx.com/water](http://www.idexx.com/water)**

**IDEXX**

## 51-Well Quanti-Tray MPN Table

No. of wells giving positive reaction per 100 mL sample	Most Probable Number (MPN)	95% Confidence Limits	
		Lower	Upper
0	<1	0.0	3.7
1	1.0	0.3	5.6
2	2.0	0.6	7.3
3	3.1	1.1	9.0
4	4.2	1.7	10.7
5	5.3	2.3	12.3
6	6.4	3.0	13.9
7	7.5	3.7	15.5
8	8.7	4.5	17.1
9	9.9	5.3	18.8
10	11.1	6.1	20.5
11	12.4	7.0	22.1
12	13.7	7.9	23.9
13	15.0	8.8	25.7
14	16.4	9.8	27.5
15	17.8	10.8	29.4
16	19.2	11.9	31.3
17	20.7	13.0	33.3
18	22.2	14.1	35.2
19	23.8	15.3	37.3
20	25.4	16.5	39.4
21	27.1	17.7	41.6
22	28.8	19.0	43.9
23	30.6	20.4	46.3
24	32.4	21.8	48.7
25	34.4	23.3	51.2
26	36.4	24.7	53.9
27	38.4	26.4	56.6
28	40.6	28.0	59.5
29	42.9	29.7	62.5
30	45.3	31.5	65.6
31	47.8	33.4	69.0
32	50.4	35.4	72.5
33	53.1	37.5	76.2
34	56.0	39.7	80.1
35	59.1	42.0	84.4
36	62.4	44.6	88.8
37	65.9	47.2	93.7
38	69.7	50.0	99.0
39	73.8	53.1	104.8
40	78.2	56.4	111.2
41	83.1	59.9	118.3
42	88.5	63.9	126.2
43	94.5	68.2	135.4
44	101.3	73.1	146.0
45	109.1	78.6	158.7
46	118.4	85.0	174.5
47	129.8	92.7	195.0
48	144.5	102.3	224.1
49	165.2	115.2	272.2
50	200.5	135.8	387.6
51	> 200.5	146.1	infinite

# IDEXX Quanti-Tray

Version Française

## Introduction

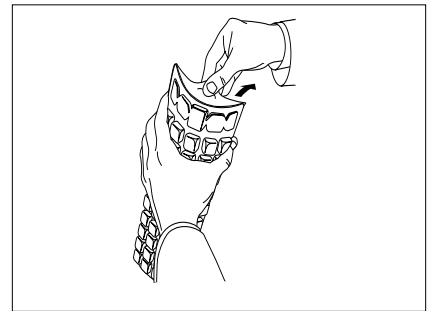
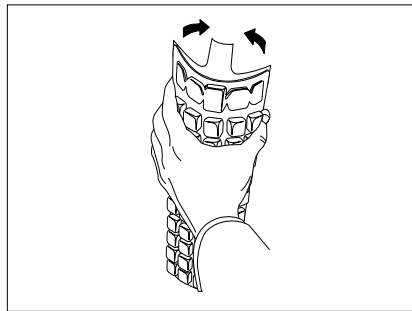
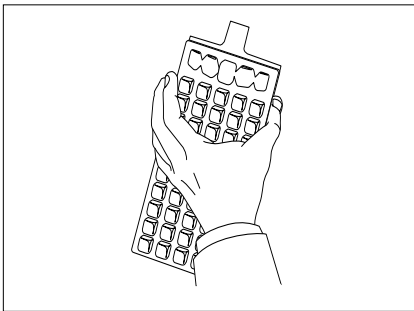
Les plateaux Quanti-Tray d'IDEXX, spécialement conçus pour des numérations bactériennes sur des échantillons de 100 millilitres, font appel à la technologie Defined Substrate Technology d'IDEXX basée sur l'utilisation de réactifs. Versez le mélange réactif/échantillon dans un Quanti-Tray, placez ensuite le tout dans le Quanti-Tray Sealer et procédez à l'incubation du mélange selon les instructions accompagnant les réactifs. Comptez ensuite le nombre de cupules positives et référez-vous à la table ci-dessous pour déterminer le nombre le plus probable (NPP).

## Contenu

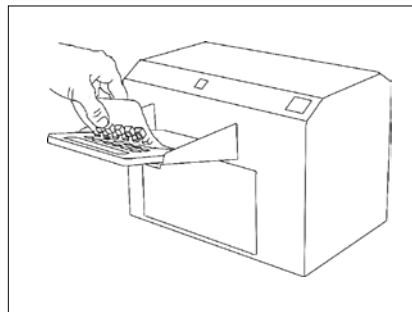
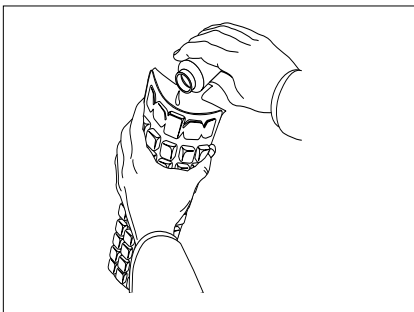
Cette boîte contient 100 Quanti-Tray stériles composés chacun de 51 cupules.

## Mode d'emploi

1. Prenez un Quanti-Tray et tenez-le à la verticale en veillant à orienter les cupules vers la paume de la main.
2. Appuyez sur la partie supérieure du Quanti-Tray afin qu'il vienne se loger dans la paume de la main.
3. Ouvrez le Quanti-Tray en écartant la languette en aluminium des cupules. Évitez tout contact avec la partie intérieure de l'aluminium ou du plateau.



4. Versez directement le mélange réactif/échantillon dans le Quanti-Tray en évitant tout contact avec la languette d'aluminium. Laissez la mousse se dissiper.
5. Placez le Quanti-Tray rempli d'échantillons sur le porte-plateau en caoutchouc du Quanti-Tray Sealer en veillant à orienter les cupules (parties en plastique) vers le bas afin qu'elles viennent s'encaster parfaitement dans le porte-plateau.



6. Scellez le Quanti-Tray conformément aux instructions accompagnant le Sealer.
7. Incubez conformément aux instructions accompagnant le réactif.
8. Comptez le nombre de cupules positives, puis référez-vous à la table NPP au verso pour déterminer le nombre le plus probable (NPP).
9. Débarrassez-vous du milieu en suivant les bonnes pratiques de laboratoire.

**Services techniques IDEXX**  
00800-4339-9111  
[www.idexx.fr/eau](http://www.idexx.fr/eau)

**IDEXX**



**Table NPP du Quanti-Tray a "51 Cupules"**

Nombre de cupules donnant une réaction positive par échantillon de 100 ml	Nombre le plus probable	Limites de confiance à 95%	
		Minimum	Maximum
0	<1	0.0	3.7
1	1.0	0.3	5.6
2	2.0	0.6	7.3
3	3.1	1.1	9.0
4	4.2	1.7	10.7
5	5.3	2.3	12.3
6	6.4	3.0	13.9
7	7.5	3.7	15.5
8	8.7	4.5	17.1
9	9.9	5.3	18.8
10	11.1	6.1	20.5
11	12.4	7.0	22.1
12	13.7	7.9	23.9
13	15.0	8.8	25.7
14	16.4	9.8	27.5
15	17.8	10.8	29.4
16	19.2	11.9	31.3
17	20.7	13.0	33.3
18	22.2	14.1	35.2
19	23.8	15.3	37.3
20	25.4	16.5	39.4
21	27.1	17.7	41.6
22	28.8	19.0	43.9
23	30.6	20.4	46.3
24	32.4	21.8	48.7
25	34.4	23.3	51.2
26	36.4	24.7	53.9
27	38.4	26.4	56.6
28	40.6	28.0	59.5
29	42.9	29.7	62.5
30	45.3	31.5	65.6
31	47.8	33.4	69.0
32	50.4	35.4	72.5
33	53.1	37.5	76.2
34	56.0	39.7	80.1
35	59.1	42.0	84.4
36	62.4	44.6	88.8
37	65.9	47.2	93.7
38	69.7	50.0	99.0
39	73.8	53.1	104.8
40	78.2	56.4	111.2
41	83.1	59.9	118.3
42	88.5	63.9	126.2
43	94.5	68.2	135.4
44	101.3	73.1	146.0
45	109.1	78.6	158.7
46	118.4	85.0	174.5
47	129.8	92.7	195.0
48	144.5	102.3	224.1
49	165.2	115.2	272.2
50	200.5	135.8	387.6
51	> 200.5	146.1	infini

# IDEXX Quanti-Tray

Version Italiano

## Introduzione

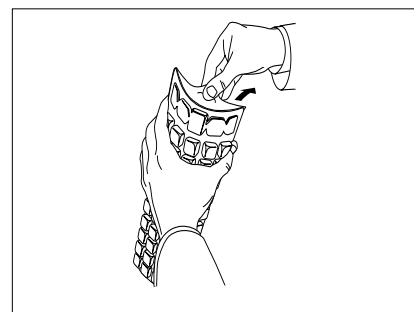
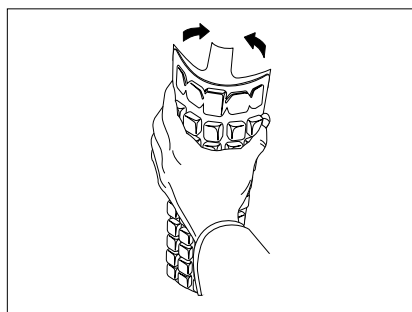
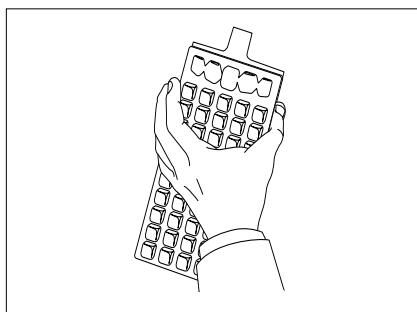
Quanti-Tray IDEXX sono concepiti per fornire la densità batterica (quantitativa) di campioni da 100 mL utilizzando reagenti Defined Substrate Technology IDEXX. Aggiungere la miscela di reagente/campione ad un Quanti-Tray, inserire quest'ultimo nel Quanti-Tray Sealer ed incubare in conformità alle istruzioni fornite con il reagente. Contare quindi il numero di pozzetti positivi e, con l'ausilio della tabella MPN allegata, determinare il numero più probabile (MPN).

## Contenuto

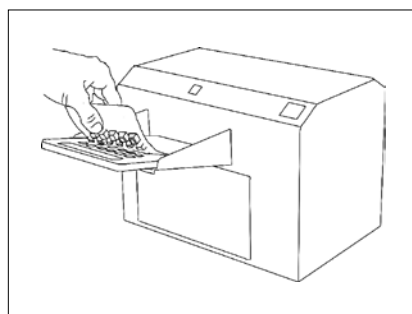
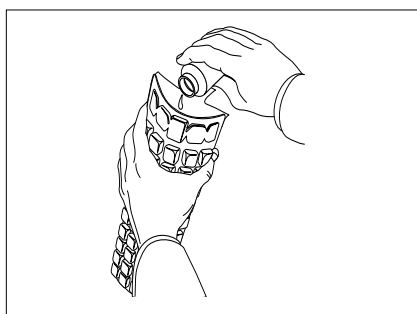
Questa confezione contiene Quanti-Tray sterili, a 51 pozzetti.

## Istruzioni per l'uso

1. Con una mano, tenere il Quanti-Tray in posizione verticale, con il lato dei pozzetti rivolto verso il palmo.
2. Comprimerne la parte superiore del Quanti-Tray in modo da fletterlo verso il palmo.
3. Aprire il Quanti-Tray tirando la linguetta in alluminio in direzione opposta al lato dei pozzetti. Evitare di toccare la parte interna del foglio protettivo in alluminio o del dispositivo a pozzetti.



4. Versare direttamente la miscela di reagente/campione nel Quanti-Tray, evitando di toccare la linguetta in alluminio. Consentire alla schiuma di sedimentare.
5. Una volta versata la miscela, collocare il Quanti-Tray nel portapozzetti in gomma del Quanti-Tray Sealer, con il lato dei pozzetti (in plastica) rivolto verso il basso, in modo da assicurarne il corretto posizionamento.
6. Sigillare secondo le istruzioni del Quanti-Tray Sealer.
7. Incubare secondo le istruzioni fornite con il reagente.
8. Contare i pozzetti positivi e consultare la tabella MPN sul retro del foglio delle istruzioni, per individuare il numero più probabile. (MPN) corretto.
9. Eliminare il terreno in accordo alle Buone pratiche di laboratorio.



**Supporto Tecnico IDEXX**  
**00800-4339-9111**  
**[www.idexx.it/acqua](http://www.idexx.it/acqua)**

**IDEXX**

## Tabella MPN Quanti-Tray a 51 pozzetti

N° di pozzetti positivi in un campione da 100 ml	Numero più probabile	Limiti fiduciali del 95% Inferiore	Limiti fiduciali del 95% Superiore
0	<1	0.0	3.7
1	1.0	0.3	5.6
2	2.0	0.6	7.3
3	3.1	1.1	9.0
4	4.2	1.7	10.7
5	5.3	2.3	12.3
6	6.4	3.0	13.9
7	7.5	3.7	15.5
8	8.7	4.5	17.1
9	9.9	5.3	18.8
10	11.1	6.1	20.5
11	12.4	7.0	22.1
12	13.7	7.9	23.9
13	15.0	8.8	25.7
14	16.4	9.8	27.5
15	17.8	10.8	29.4
16	19.2	11.9	31.3
17	20.7	13.0	33.3
18	22.2	14.1	35.2
19	23.8	15.3	37.3
20	25.4	16.5	39.4
21	27.1	17.7	41.6
22	28.8	19.0	43.9
23	30.6	20.4	46.3
24	32.4	21.8	48.7
25	34.4	23.3	51.2
26	36.4	24.7	53.9
27	38.4	26.4	56.6
28	40.6	28.0	59.5
29	42.9	29.7	62.5
30	45.3	31.5	65.6
31	47.8	33.4	69.0
32	50.4	35.4	72.5
33	53.1	37.5	76.2
34	56.0	39.7	80.1
35	59.1	42.0	84.4
36	62.4	44.6	88.8
37	65.9	47.2	93.7
38	69.7	50.0	99.0
39	73.8	53.1	104.8
40	78.2	56.4	111.2
41	83.1	59.9	118.3
42	88.5	63.9	126.2
43	94.5	68.2	135.4
44	101.3	73.1	146.0
45	109.1	78.6	158.7
46	118.4	85.0	174.5
47	129.8	92.7	195.0
48	144.5	102.3	224.1
49	165.2	115.2	272.2
50	200.5	135.8	387.6
51	> 200.5	146.1	Infinito

# IDEXX Quanti-Tray

Versión Español

## Introducción

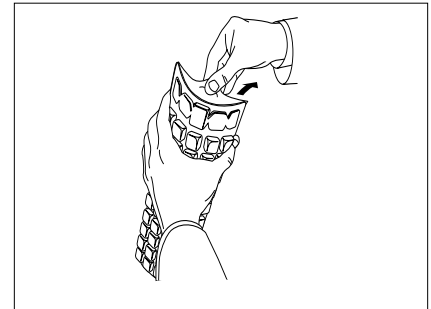
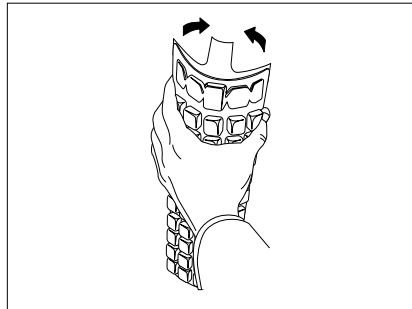
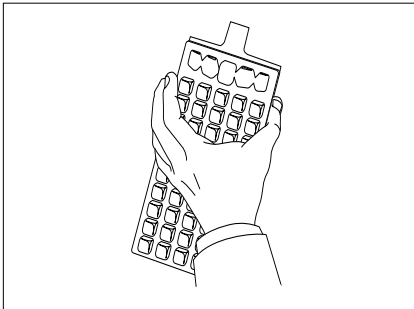
Los dispositivos Quanti-Tray de IDEXX están diseñados para producir recuentos bacterianos cuantificados de muestras de 100 mL, al ser utilizadas con productos de reactivos de la Tecnología del Sustrato Definido (Defined Substrate Technology) de IDEXX. Agregue la mezcla de reactivo y muestra a un dispositivo Quanti-Tray, séllelo en el Quanti-Tray Sealer (Sellador) e incúbela según las instrucciones del reactivo. Luego cuente el número de celdas positivas y utilice la tabla de NMP adjunta para determinar el Número Más Probable (NMP).

## Contenido

Este paquete contiene 100 dispositivos Quanti-Tray estériles, de 51 celdas c/u.

## Instrucciones para el usuario

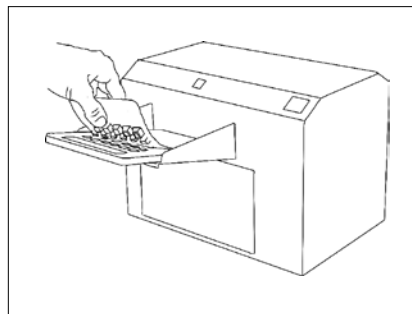
1. Sostenga en una mano el dispositivo Quanti-Tray en posición vertical, con el lado de las celdas orientado hacia la palma.
2. Apriete la parte superior de el dispositivo Quanti-Tray de modo de doblarla hacia la palma.
3. Abra el dispositivo Quanti-Tray desprendiendo la lengüeta metálica del lado que contiene las celdas. Evite tocar el interior del metal o del dispositivo.



4. Vierta la mezcla de reactivo y la muestra directamente dentro de el dispositivo Quanti-Tray, evitando tocar la lengüeta metálica. Deja reposar la espuma.



5. Coloque el dispositivo Quanti-Tray lleno de muestra sobre el portadispositivo de goma del sellador Quanti-Tray, orientando el lado de las celdas (plásticas) del dispositivo hacia abajo de manera que quepa en el portadispositivo.



6. Selle el dispositivo según las instrucciones del sellador.
7. Incube de acuerdo con las instrucciones del reactivo.
8. Cuente las celdas positivas. Para determinar el número más probable, recurra a la tabla NMP al dorso de esta hoja de instrucciones.
9. Verter el medio de cultivo conforme a Buenas Prácticas del Laboratorio.

Soporte técnico de IDEXX  
00800-4339-9111  
[www.idexx.es/agua](http://www.idexx.es/agua)

**IDEXX**

## Tabla de NMP para dispositivo Quanti-Tray de 51 celdas

Nº de celdas que producen una reacción positiva, por muestra de 100 ml	Número más probable	Límites de confianza del 95%	
		Inferior	Superior
0	<1	0.0	3.7
1	1.0	0.3	5.6
2	2.0	0.6	7.3
3	3.1	1.1	9.0
4	4.2	1.7	10.7
5	5.3	2.3	12.3
6	6.4	3.0	13.9
7	7.5	3.7	15.5
8	8.7	4.5	17.1
9	9.9	5.3	18.8
10	11.1	6.1	20.5
11	12.4	7.0	22.1
12	13.7	7.9	23.9
13	15.0	8.8	25.7
14	16.4	9.8	27.5
15	17.8	10.8	29.4
16	19.2	11.9	31.3
17	20.7	13.0	33.3
18	22.2	14.1	35.2
19	23.8	15.3	37.3
20	25.4	16.5	39.4
21	27.1	17.7	41.6
22	28.8	19.0	43.9
23	30.6	20.4	46.3
24	32.4	21.8	48.7
25	34.4	23.3	51.2
26	36.4	24.7	53.9
27	38.4	26.4	56.6
28	40.6	28.0	59.5
29	42.9	29.7	62.5
30	45.3	31.5	65.6
31	47.8	33.4	69.0
32	50.4	35.4	72.5
33	53.1	37.5	76.2
34	56.0	39.7	80.1
35	59.1	42.0	84.4
36	62.4	44.6	88.8
37	65.9	47.2	93.7
38	69.7	50.0	99.0
39	73.8	53.1	104.8
40	78.2	56.4	111.2
41	83.1	59.9	118.3
42	88.5	63.9	126.2
43	94.5	68.2	135.4
44	101.3	73.1	146.0
45	109.1	78.6	158.7
46	118.4	85.0	174.5
47	129.8	92.7	195.0
48	144.5	102.3	224.1
49	165.2	115.2	272.2
50	200.5	135.8	387.6
51	> 200.5	146.1	infinito

# IDEXX Quanti-Tray

Deutsch Version

## Einführung

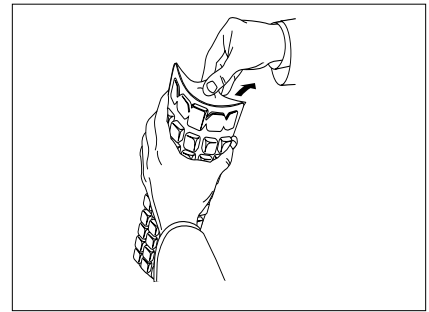
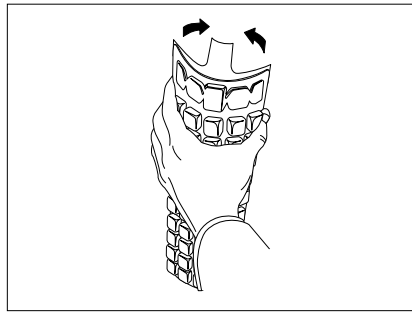
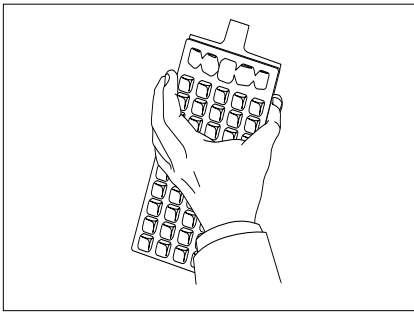
Quanti-Tray von IDEXX dienen zur quantitativen Bakterienzählung in 100-mL-Proben unter Verwendung von IDEXX Defined Substrate Technology-Reagenzien. Die Mischung aus Probe und Reagenz in einen Quanti-Tray geben, diesen in einem Quanti-Tray-Versiegelungsgerät verschließen und laut Reagenz-Packungsbeilage inkubieren. Anschließend die Anzahl der positiven Vertiefungen zählen und mit der beigelegten MPN-Tabelle die "Wahrscheinlichste Anzahl" (MPN) bestimmen.

## Inhalt

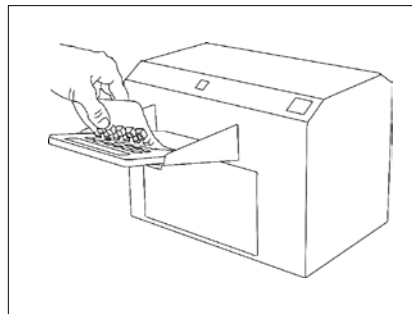
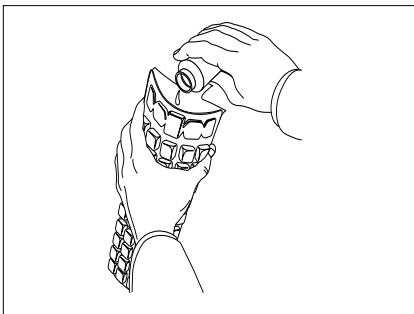
Diese Packung enthält 100 sterile Quanti-Tray mit jeweils 51 Vertiefungen.

## Gebrauchsanweisung

1. Quanti-Tray mit einer Hand fassen und senkrecht halten, wobei die Seite mit den Vertiefungen zur Handfläche zeigt.
2. Den oberen Teil des Quanti-Trays zusammendrücken, so daß sich der Träger zur Handfläche hin biegt.
3. Quanti-Tray öffnen, indem die Folienlasche von der Seite mit den Vertiefungen abgezogen wird. Die Innenseite der Folie oder des Trays nicht berühren.



4. Die Mischung aus Probe und Reagenz direkt in einen Quanti-Tray gießen. Dabei eine Berührung der Folienlasche vermeiden. Schaum einwirken lassen.
5. Den mit der Probe gefüllten Quanti-Tray auf die Gummi-Trägerunterlage des Quanti-Tray-Versiegelungsgeräts stellen. Die Seite mit den Vertiefungen (Kunststoff) des Quanti-Trays muß dabei nach unten weisen, damit sie in die Unterlage paßt.
6. Das Verschließen erfolgt laut Anweisungen für das Versiegelungsgerät.
7. Entsprechend den Reagenzanweisungen inkubieren.
8. Die positiven Vertiefungen zählen und mit Hilfe der MPN-Tabelle auf der Rückseite dieser Packungsbeilage die Wahrscheinlichste Anzahl (MPN) ermitteln.
9. Entsorgen Sie die Quanti-Trays gemäß guter Laborpraxis.



**IDEXX Technischer Dienst**  
00800-4339-9111  
[www.idexx.de/wasser](http://www.idexx.de/wasser)

**IDEXX**

## MPN-Tabelle für Quanti-Tray mit 51 Vertiefungen

Anzahl der Vertiefungen, die bei einer 100-ml-Probe positiv reagieren	Wahrscheinlichste Anzahl	95% Vertrauensgrenze	
		Untere	Obere
0	<1	0.0	3.7
1	1.0	0.3	5.6
2	2.0	0.6	7.3
3	3.1	1.1	9.0
4	4.2	1.7	10.7
5	5.3	2.3	12.3
6	6.4	3.0	13.9
7	7.5	3.7	15.5
8	8.7	4.5	17.1
9	9.9	5.3	18.8
10	11.1	6.1	20.5
11	12.4	7.0	22.1
12	13.7	7.9	23.9
13	15.0	8.8	25.7
14	16.4	9.8	27.5
15	17.8	10.8	29.4
16	19.2	11.9	31.3
17	20.7	13.0	33.3
18	22.2	14.1	35.2
19	23.8	15.3	37.3
20	25.4	16.5	39.4
21	27.1	17.7	41.6
22	28.8	19.0	43.9
23	30.6	20.4	46.3
24	32.4	21.8	48.7
25	34.4	23.3	51.2
26	36.4	24.7	53.9
27	38.4	26.4	56.6
28	40.6	28.0	59.5
29	42.9	29.7	62.5
30	45.3	31.5	65.6
31	47.8	33.4	69.0
32	50.4	35.4	72.5
33	53.1	37.5	76.2
34	56.0	39.7	80.1
35	59.1	42.0	84.4
36	62.4	44.6	88.8
37	65.9	47.2	93.7
38	69.7	50.0	99.0
39	73.8	53.1	104.8
40	78.2	56.4	111.2
41	83.1	59.9	118.3
42	88.5	63.9	126.2
43	94.5	68.2	135.4
44	101.3	73.1	146.0
45	109.1	78.6	158.7
46	118.4	85.0	174.5
47	129.8	92.7	195.0
48	144.5	102.3	224.1
49	165.2	115.2	272.2
50	200.5	135.8	387.6
51	> 200.5	146.1	endlos

# IDEXX Quanti-Tray

日本語版

## はじめに

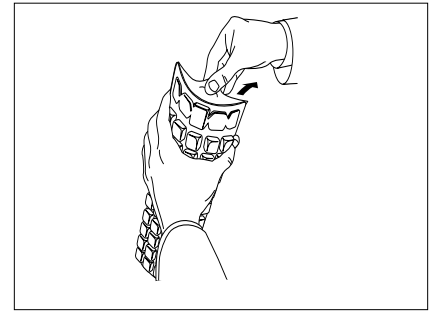
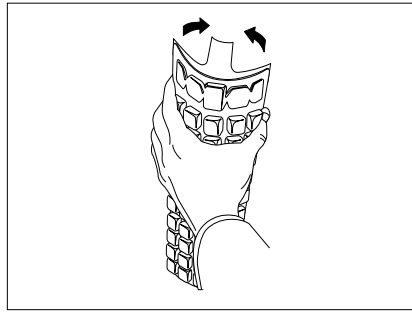
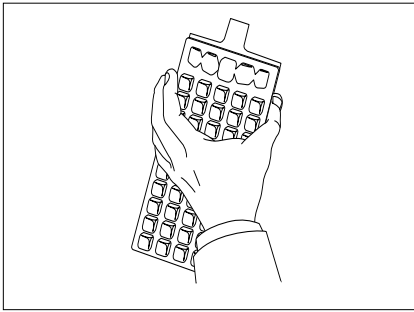
IDEXX Quanti-Tray(QT-トレイ)は、IDEXXが特許を取得しているDefined Substrate Technology(特定酵素基質法)に基づいたColilertを用い、検体100mL中の最確数を測定する新しいシステムです。Colilertと検体の混合液をQuanti-Trayに加え、シーラーで封入し、取扱説明書に従い培養してください。その後、陽性ウェル数を数え、添付の最確数(MPN)表を用いて、MPNを測定します。

## 内容

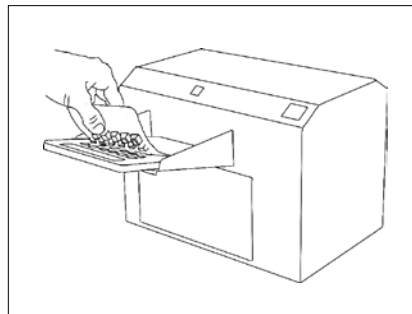
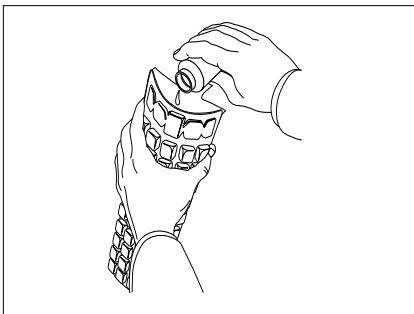
このパッケージには、滅菌済みの51ウェル Quanti-Tray が100個入っています。

## 操作手順

1. ウェル側を手のひらに向けてトレイを垂直に持ってください。
2. トレイが手のひらに向かって曲がるように、トレイの上部を強く握ってください。
3. トレイのつまみをウェル側から引き離して、注入口を広げてください。トレイのつまみ、またはトレイの内部に触れないようにしてください。



4. トレイのつまみにかからないように直接、Colilertと検体の混合液を注いでください。気泡は軽く指ではじくように取り除いてください。
5. 検体の入ったトレイをシーラーのゴム製シートの上にウェル側を下に向けてセットしてください。
6. シーラーの取扱説明書に従って密封してください。
7. Colilertの取扱説明書に従って培養してください。
8. 陽性ウェル数を数え、添付の最確数(MPN)表を使用してMPNを求めてください。
9. 検体及びトレイの廃棄は、高圧滅菌してください。



ご質問やサポートに関しては以下にご連絡ください。

アイデックス ラボラトリーズ株式会社  
TEL: 0422-71-5921 [www.idexx.co.jp/water](http://www.idexx.co.jp/water)

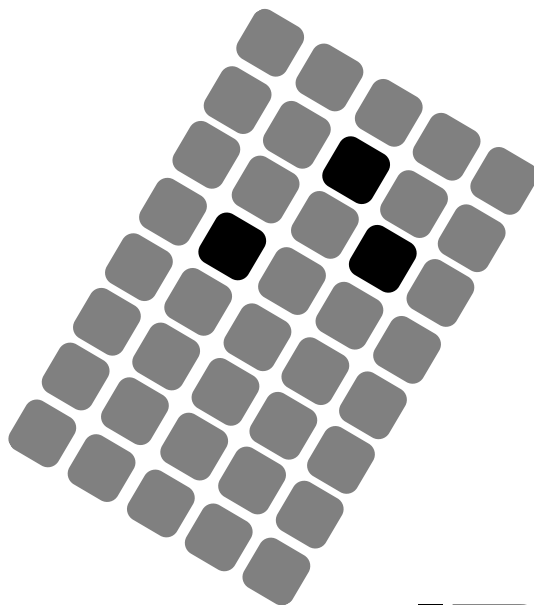
**IDEXX**



## 51 ウェル Quanti-Tray MPN 表

100ml の検体で陽性 反応を呈するウェル数	最確数 (MPN)	95% 信頼限界	
		下限	上限
0	<1	0.0	3.7
1	1.0	0.3	5.6
2	2.0	0.6	7.3
3	3.1	1.1	9.0
4	4.2	1.7	10.7
5	5.3	2.3	12.3
6	6.4	3.0	13.9
7	7.5	3.7	15.5
8	8.7	4.5	17.1
9	9.9	5.3	18.8
10	11.1	6.1	20.5
11	12.4	7.0	22.1
12	13.7	7.9	23.9
13	15.0	8.8	25.7
14	16.4	9.8	27.5
15	17.8	10.8	29.4
16	19.2	11.9	31.3
17	20.7	13.0	33.3
18	22.2	14.1	35.2
19	23.8	15.3	37.3
20	25.4	16.5	39.4
21	27.1	17.7	41.6
22	28.8	19.0	43.9
23	30.6	20.4	46.3
24	32.4	21.8	48.7
25	34.4	23.3	51.2
26	36.4	24.7	53.9
27	38.4	26.4	56.6
28	40.6	28.0	59.5
29	42.9	29.7	62.5
30	45.3	31.5	65.6
31	47.8	33.4	69.0
32	50.4	35.4	72.5
33	53.1	37.5	76.2
34	56.0	39.7	80.1
35	59.1	42.0	84.4
36	62.4	44.6	88.8
37	65.9	47.2	93.7
38	69.7	50.0	99.0
39	73.8	53.1	104.8
40	78.2	56.4	111.2
41	83.1	59.9	118.3
42	88.5	63.9	126.2
43	94.5	68.2	135.4
44	101.3	73.1	146.0
45	109.1	78.6	158.7
46	118.4	85.0	174.5
47	129.8	92.7	195.0
48	144.5	102.3	224.1
49	165.2	115.2	272.2
50	200.5	135.8	387.6
51	> 200.5	146.1	以上

- **IDEXX Quanti-Tray\* Sealer Model 2X  
User Manual**
- **IDEXX Quanti-Tray\* Sealer Modèle 2X  
Manuel de l'utilisateur**
- **Manual del usuario del Sellador Quanti-Tray\*  
Modelo 2X**
- **Sigillatrice IDEXX Quanti-Tray\* Modello 2X  
Manuale d'uso**
- **Quanti-Tray\* Versiegelungsgerät Modell 2X  
Benutzeranleitung**





# IDEXX Quanti-Tray\* Sealer Model 2X User Manual

## CAUTION



**CAUTION: RISK OF ELECTRICAL SHOCK**

Do not open the cover of this Sealer.



Do not allow water to spill into this Sealer.

Pour water samples into Quanti-Trays as described in the Quanti-Tray insert.



**CAUTION: RISK OF SKIN BURNS**

Your company/institution may qualify personnel for cleaning the inside of the Sealer. Qualified personnel should refer to the Preventive Maintenance Instructions for directions on how to clean the inside of the Sealer.

---

IDEXX Laboratories, Inc. One IDEXX Drive, Westbrook, Maine 04092 USA • Tel.: 1-207-856-0496 or 1-800-321-0207 Fax: 1-207-856-0630

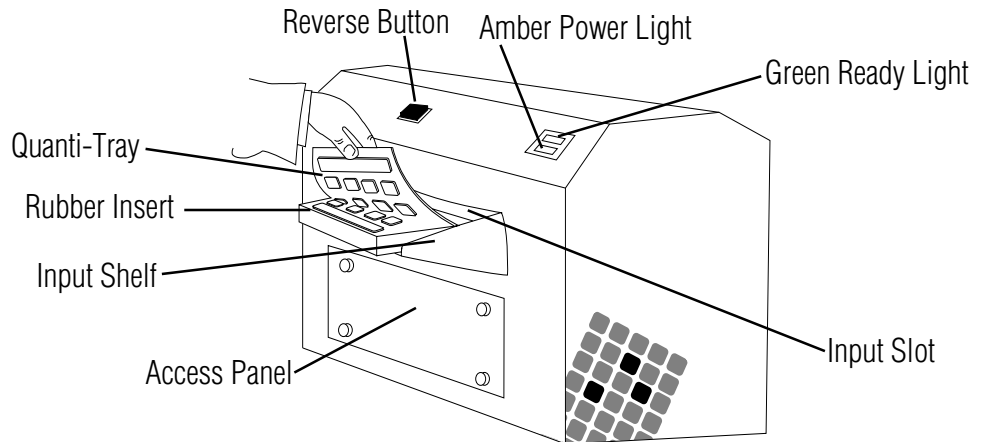
[www.idexx.com](http://www.idexx.com)

**IDEXX**

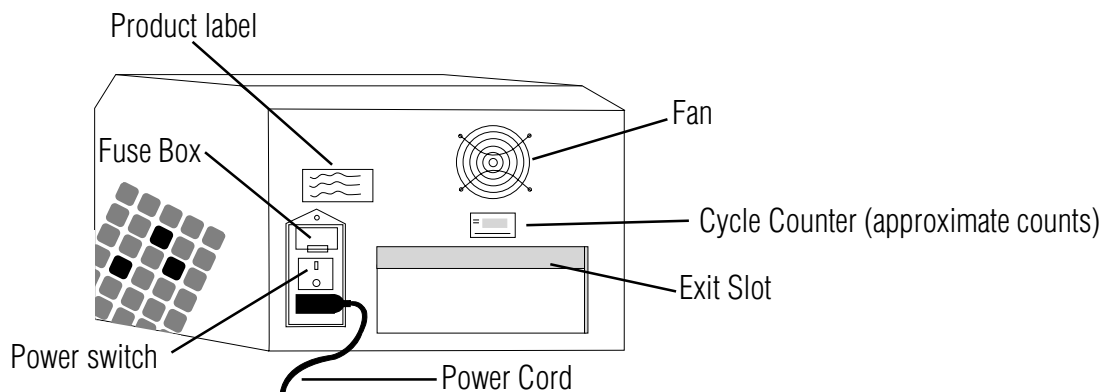
## Description

The IDEXX Quanti-Tray<sup>®</sup> Sealer Model 2X is a motor-driven, heated roller instrument designed to seal IDEXX Quanti-Trays (including Quanti-Tray<sup>®</sup> /2000s). This Sealer, used with Quanti-Trays and any IDEXX Defined Substrate Technology<sup>®</sup> reagent, like Colilert<sup>®</sup>, Colilert<sup>®</sup>-18, Colisure<sup>®</sup> and Enterolert<sup>®</sup>, automates the sample handling of bacterial enumeration. Together, they produce counts as accurate as membrane filtration with the ease of a presence/absence test.

**Diagram 1**



**Diagram 2**



## Contents

Each Model 2X Sealer comes with the base Sealer unit, an input shelf, one Quanti-Tray<sup>®</sup> Rubber Insert, MPN tables, this User Manual, and Preventive Maintenance Instructions. The 115V model also comes with a standard US, 3-prong grounding power cord. The 230V model also comes with 3 cords: a UK cord, a European/Shuko cord, and a Swiss cord.

**Note:** Quanti-Tray/2000 Rubber Inserts (WQTSRBR-2k) are available separately. Extra Quanti-Tray Rubber Inserts (WQTSRBR-51) are also available separately.

## Setting Up

- Unpack contents and save packaging for future shipping.
- Position Sealer on a level surface with adequate space for Trays to be inserted and ejected. Sealer can be used in any orientation (left-to-right or right-to-left).
- Attach Input Shelf to Sealer by inserting shelf tabs into the two slots on the front of the Sealer and clipping firmly in place.
- Ensure that Power Switch is turned off.
- Plug power cord into Sealer and then into a grounded outlet of proper voltage (see Product Label).

## Operating Directions

**Warning: Personal injury, Sealer damage, property damage and/or inaccurate test results may occur unless Sealer is used according to these instructions.**

- Turn Power Switch on. The amber Power Light should illuminate.
- Allow the Sealer to warm up and the green Ready Light to come on (up to 10 minutes). Sealer will not operate until both the amber power light and the green Ready Light are illuminated, indicating that the unit has reached operating temperature.
- Place an empty Quanti-Tray or Quanti-Tray/2000 Rubber Insert on the Input Shelf with the large cutout facing away from the Sealer.
- Place a Quanti-Tray or Quanti-Tray/2000 filled with sample and DST\* reagent onto the Rubber Insert, making sure that the Tray is properly seated in the Rubber Insert, and with each well of the Tray in its corresponding Rubber Insert hole.
- Slide the Rubber Insert with Tray into the Sealer until the motor grabs the Rubber Insert and begins to draw it into the Sealer.
- In approximately 15 seconds, the Tray will be sealed and partially ejected from the rear of the Sealer. Remove the Rubber Insert and Tray from the rear of the Sealer.
- If at any time you wish to reverse the motor drawing the Rubber Insert into the Sealer (for example, if a misaligned Tray is accidentally fed into the Sealer), press and hold the Reverse Button. However, do not reverse the motor once the Rubber Insert has been drawn fully into the Input Slot.
- Multiple Rubber Inserts can be run consecutively without pausing.
- Turn off Sealer when not in use.

## Technical Specifications

Weight	Dimensions	Ambient Temperature	Power
35 lbs	12" H x 11" D x 16" W	32-90°F	115V, 60Hz, 6Amp (model 99-10893-00)
16 kg	30cm H x 27cm D x 39cm W	0-32°C	230V, 50Hz, 3Amp (model 99-10896-00)

## Cleaning

The Rubber Insert may be autoclaved, or it may be cleaned with isopropyl alcohol or household bleach, taking the usual precautions when handling such liquids. Be sure to clean the rubber insert if it shows any signs of built up grime.

Clean the outside of the Sealer with a soft, dry cloth. A soft cloth moistened with water, household bleach, or isopropyl alcohol may also be used, taking the usual precautions when handling such liquids.

The Access Panel should only be opened by personnel qualified to clean the inside of the Sealer. Refer to the Preventive Maintenance Instructions for directions on how to clean the inside of the Sealer. **Cleaning should only be performed by trained personnel at your facility.** Do not open the Access Panel or tilt the Sealer if sample is dripping from the unit.

## Changing Fuses

Fuses are located in the fuse holder just above the Power Switch. If it is necessary to change a fuse, turn off the Sealer and unplug the Power Cord from the Sealer before opening fuse holder. Use 6 Amp Buss MDL-6 fuses or equivalent in the 115V unit and 4 Amp Buss GDC-4 fuses or equivalent in the 230V unit.

## Troubleshooting

Symptom	Recommended Action
Amber Power Light doesn't illuminate.	<ul style="list-style-type: none"> <li>• Verify that the Sealer is plugged into a live outlet.</li> <li>• Ensure that the power switch is on.</li> <li>• Check fuses and replace if necessary.</li> </ul>
Amber Power Light comes on, but the Green Ready Light takes more than 20 minutes to turn on or goes off during operation.	<ul style="list-style-type: none"> <li>• Call IDEXX Technical Support or your local distributor.</li> </ul>
Motor won't start when a Quanti-Tray is inserted.	<ul style="list-style-type: none"> <li>• Be sure that Sealer has warmed up and that the green Ready Light is illuminated.</li> <li>• Be sure that the Quanti-Tray is face down in the Rubber Insert with the white Tray backing facing upward.</li> </ul>
Motor starts when Quanti-Tray is inserted, but doesn't pull Tray through.	<ul style="list-style-type: none"> <li>• Be sure Tray is in the Rubber Insert.</li> <li>• Ensure that Rubber Insert is pushed firmly into roller until motor engages it.</li> <li>• Clean Rubber Insert.</li> </ul>
Quanti-Tray and Rubber Insert get stuck in Sealer.	<ul style="list-style-type: none"> <li>• Press and HOLD the Reverse Button to reverse the motor until the Tray is ejected from the Input Slot. <b>NOTE:</b> If the Tray has gone all the way into the Sealer, do not use Reverse Button because the Tray may become lodged in the Sealer. Instead, pull the Rubber Insert out the Exit Slot.</li> </ul>
Sealer makes loud hissing noise when sealing or liquid is dripping from the bottom of the Sealer.	<ul style="list-style-type: none"> <li>• This is part of normal operation when trays are over filled. Do not fill Trays with more than 100ml of sample. The Sealer is designed to automatically remove excess sample from the Tray and discard it into the bottom of the Sealer.</li> </ul>
Trays appear to have blistered, or paper backing is yellowed, after sealing.	<ul style="list-style-type: none"> <li>• Call IDEXX Technical Support or your local distributor. Sealer heated roller may be running too hot.</li> </ul>

### LIMITED WARRANTY

IDEXX Laboratories, Inc. ("IDEXX") warrants this product to conform to our published specifications, when stored under appropriate conditions and given normal, proper and intended usage, until the expiration of its stated shelf life, or, if none is stated, for one year from the date of delivery of this product to the original end user purchaser ("Buyer"). IDEXX agrees during the applicable warranty period to replace all non-conforming products within 30 days after date of return to IDEXX and without cost to Buyer. IDEXX shall not have any obligation under this Limited Warranty to make replacements which result, in whole or in part, from catastrophe, fault or negligence of the Buyer, or anyone claiming through or on behalf of the Buyer, or from improper use of the products, or use of the products in a manner for which they were not designed, or by causes external to the products.

Buyer shall notify IDEXX of any products which it believes to be non-conforming during the warranty period. At IDEXX's option, such products shall be returned by Buyer, transportation and insurance prepaid, to IDEXX's designated facility for examination and testing. IDEXX shall repair or replace, within 30 days of receipt by IDEXX, any such product found to be so non-conforming and promptly return such products to Buyer, transportation and insurance prepaid. Should IDEXX's examination and testing not disclose any non-conformity covered by the foregoing warranty, IDEXX shall so advise Buyer and dispose of or return the product in accordance with Buyer's instructions and at Buyer's sole expense.

**THE PROVISIONS OF THE FOREGOING LIMITED WARRANTY ARE IN LIEU OF ANY OTHER WARRANTY, WHETHER EXPRESS OR IMPLIED, WRITTEN OR ORAL (INCLUDING ANY WARRANTY OF MERCHANTABILITY OR FITNESS FOR A PARTICULAR PURPOSE). IDEXX'S LIABILITY ARISING OUT OF THE MANUFACTURE, SALE OR SUPPLYING OF THE PRODUCTS OR THEIR USE OR DISPOSITION, WHETHER BASED UPON WARRANTY, CONTRACT, TORT OR OTHERWISE, SHALL NOT EXCEED THE ACTUAL PURCHASE PRICE PAID BY BUYER FOR THE PRODUCTS. IN NO EVENT SHALL IDEXX BE LIABLE TO BUYER OR ANY OTHER PERSON OR ENTITY FOR SPECIAL, INCIDENTAL, CONSEQUENTIAL, INDIRECT OR EXEMPLARY DAMAGES (INCLUDING, BUT NOT LIMITED TO, LOSS OF PROFITS OR LOSS OF USE DAMAGES) ARISING OUT OF THE MANUFACTURE, SALE OR SUPPLY OF THE PRODUCTS. THE FOREGOING WARRANTIES EXTEND TO BUYER ONLY AND SHALL NOT BE APPLICABLE TO ANY OTHER PERSON OR ENTITY INCLUDING, WITHOUT LIMITATION, CUSTOMERS OF BUYER.**

## IDEXX US/Canada Technical Support

**Telephone 1-800-321-0207 or 1-207-856-0496 Fax 1-207-856-0630**

Manufactured under one or more of the following U.S. patents: 4,925,789; 5,429,933; 5,518,892; 5,610,029; 5,620,865; 5,620,895; 5,753,456 and 5,780,259. Other U.S. and/or foreign patents issued or pending.

\*Quanti-Tray, Defined Substrate Technology, Colilert, Colisure, Enterolert and DST are either trademarks or registered trademarks of IDEXX Laboratories, Inc. in the United States and/or other countries.

© 2002 IDEXX Laboratories, Inc.

# IDEXX Quanti-Tray\* Sealer Modèle 2X Manuel de l'utilisateur

## ATTENTION



### ATTENTION : RISQUE DE DECHARGES ÉLECTRIQUES

N'ouvrez pas le couvercle de votre sealer.

Ne renversez jamais d'eau à l'intérieur de votre sealer.



Versez les échantillons d'eau dans les plaques Quanti-Trays conformément aux instructions du protocole.



### ATTENTION : RISQUE DE BRÛLURES

Votre société/institution peut former du personnel pour le nettoyage de l'intérieur du sealer. Le personnel qualifié doit consulter les instructions de maintenance préventive pour ce qui concerne la manière de nettoyer l'intérieur du sealer.



## Description

Le modèle 2X du Quanti-Tray<sup>®</sup> Sealer de IDEXX est un instrument motorisé, à rouleau chauffé, conçu pour sceller les plaques Quanti-Trays IDEXX, ainsi que les Quanti-Tray<sup>®</sup>/2000s. Ce sealer, utilisé avec des Quanti-Trays et tout réactif Defined Substrate Technology<sup>®</sup> de IDEXX, comme le Colilert<sup>®</sup>, le Colilert<sup>®</sup>-18, Colisure<sup>®</sup> ou l'Enterolert<sup>®</sup>, automatise l'introduction de l'échantillon pour l'énumération bactérienne. Cette combinaison du sealer et des plaques Quanti-Tray produit des numérations aussi précises que par filtration sur membrane, avec la facilité d'un test présence/absence.

Diagramme 1

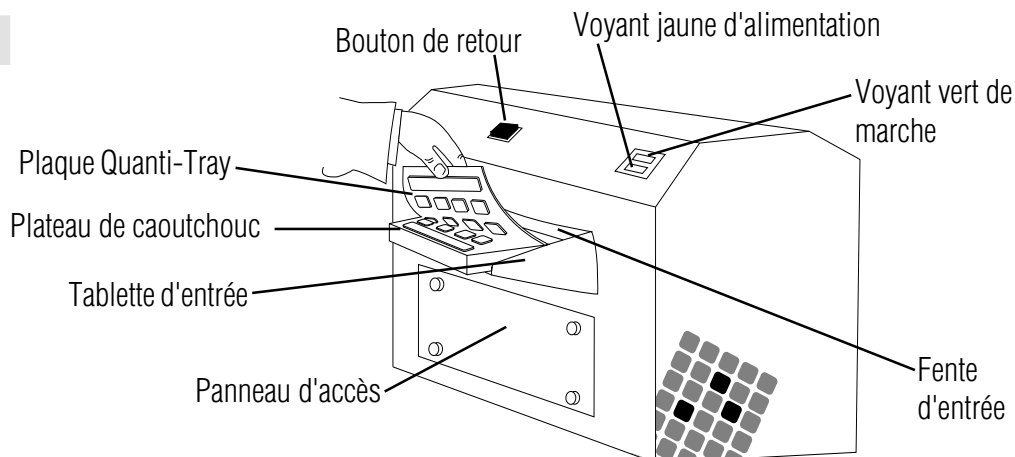
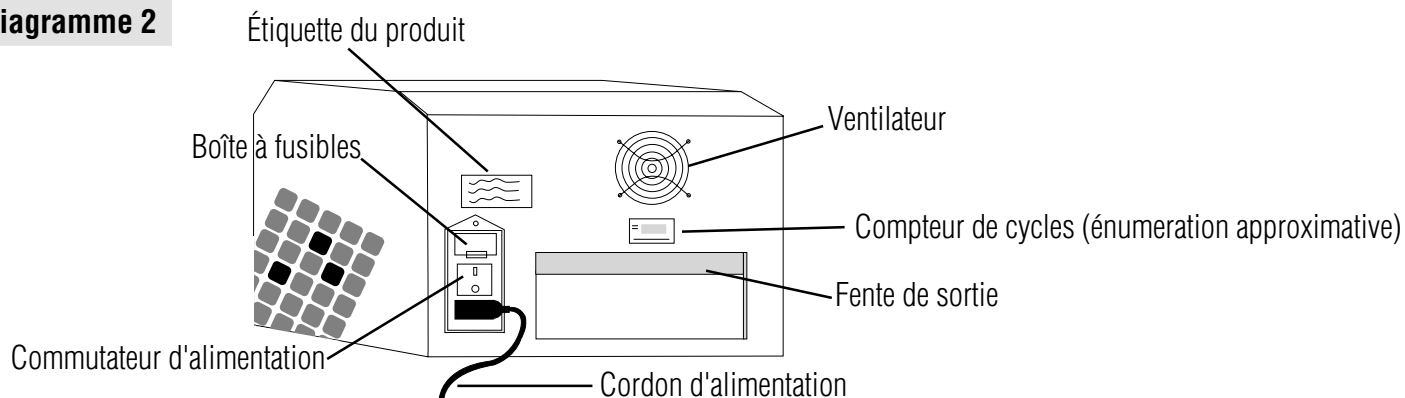


Diagramme 2



## Contenu

Chaque sealer modèle 2X comprend l'unité de base, une tablette d'entrée, un plateau de caoutchouc Quanti-Tray, des abaques de nombre le plus probable, ce manuel de l'utilisateur et des instructions de maintenance préventive. Le modèle 115V comprend également un cordon d'alimentation 3 broches avec mise à la terre normalisé US. Le modèle 230V comprend également 3 cordons: un cordon RU, un cordon européen/Shuko et un cordon suisse.

**Note:** Les plateaux de caoutchouc Quanti-Tray/2000 (WQTSRBR-2k) sont vendus séparément. Les plateaux de caoutchouc Quanti-Tray supplémentaires (WQTSRBR-51) sont aussi vendus séparément.

## Installation

- Déballez le contenu et conservez l'emballage pour toute expédition ultérieure.
- Placez votre sealer sur une surface horizontale, avec suffisamment d'espace pour permettre d'insérer et d'éjecter les Quanti-Trays. Vous pouvez utiliser votre sealer dans n'importe quel sens (de gauche à droite ou de droite à gauche).
- Fixez la tablette d'entrée à votre sealer en insérant les taquets de la tablette dans les deux fentes situées à l'avant de la machine et en les fixant solidement en place en appuyant sur la tablette.
- Assurez-vous que le commutateur d'alimentation soit bien en position "OFF" (hors tension).
- Branchez le cordon d'alimentation à votre sealer, puis à une prise de voltage adéquat avec mise à la terre (consultez l'étiquette du produit).

## Fonctionnement

**Avertissement : Vous risquez de vous blesser, d'endommager votre sealer, de causer des dommages matériels et d'obtenir des résultats de test erronés si vous ne vous conformez pas aux présentes instructions quand vous utilisez votre sealer.**

- Mettez le commutateur en position "ON" (sous tension). Le voyant jaune s'allume.
- Laissez chauffer votre sealer. Le voyant vert s'allume (cela peut prendre jusqu'à 10 minutes) ce qui indique que l'appareil a atteint sa température de fonctionnement. Votre sealer ne peut fonctionner que lorsque le voyant jaune et le voyant vert sont tous deux allumés.
- Placez un plateau de caoutchouc vide pour Quanti-Tray ou pour Quanti-Tray/2000 sur la tablette d'entrée, la plus grande alvéole vers vous.
- Placez un Quanti-Tray ou un Quanti-Tray/2000 rempli de mélange échantillon/réactif DST\* sur le plateau de caoutchouc. Assurez-vous que le Quanti-Tray repose bien sur le plateau de caoutchouc et que chaque puits du Quanti-Tray se trouve bien dans le trou du plateau de caoutchouc correspondant.
- Faites coulisser le plateau de caoutchouc avec la plaque dans le sealer jusqu'à ce que le moteur saisisse le plateau et commence à l'entraîner à l'intérieur.
- Au bout d'environ 15 secondes, le plateau est scellé et partiellement éjecté de votre sealer. Enlevez le plateau de caoutchouc et le Quanti-Tray de l'arrière de votre sealer.
- Vous pouvez récupérer la plaque Quanti-Tray et son support en maintenant enfoncé le bouton noir de retour (si, par exemple, vous avez mal aligné le plateau en le mettant dans votre sealer). Cependant, ne faites jamais retourner le plateau de caoutchouc s'il a pénétré entièrement dans la machine.
- Vous pouvez traiter consécutivement sans vous arrêter plusieurs plateaux de caoutchouc.
- Mettez votre sealer hors tension quand vous ne l'utilisez pas.

## Caractéristiques techniques

Poids	Dimensions	Température ambiante	Alimentation
35 lbs	12" H x 11" P x 16" L	32-90°F	115V, 60Hz, 6Amp (modèle 99-10893-00)
16 kg	30cm H x 27cm P x 39cm L	0-32°C	230V, 50Hz, 3Amp (modèle 99-10896-00)

## Nettoyage

Vous pouvez nettoyer le plateau de caoutchouc à l'autoclave, ou bien à l'alcool isopropylique ou à l'eau de javel domestique, en prenant les précautions d'usage. Assurez-vous de bien nettoyer le plateau de caoutchouc si vous voyez des signes d'encrassement.

Nettoyez l'extérieur de votre sealer avec un chiffon doux, sec. Vous pouvez également utiliser un chiffon doux imbibé d'eau, d'eau de javel domestique ou d'alcool isopropylique en prenant les précautions d'usage.

Le panneau d'accès ne doit être ouvert que par du personnel qualifié pour nettoyer l'intérieur du sealer. Consultez les instructions de maintenance préventive pour ce qui concerne la manière de nettoyer l'intérieur du sealer. **Le nettoyage ne doit être effectué que par du personnel formé sur les lieux.** N'ouvrez pas le panneau d'accès ou n'inclinez pas le sealer si l'échantillon s'écoule de l'unité.

## Changement des fusibles

Les fusibles sont situés dans la boîte à fusibles, juste au-dessus du commutateur. Si vous devez changer un fusible, mettez votre sealer hors tension et débranchez le cordon d'alimentation avant d'ouvrir la boîte à fusibles. Utilisez des fusibles de 6 Amp Buss MDL-6 ou leur équivalent dans un sealer de 115V et des fusibles de 4 Amp Buss GDC-4 ou leur équivalent dans un sealer de 230V.

## En cas de panne (Troubleshooting)

Symptômes	Mesures recommandées
Le voyant jaune d'alimentation ne s'allume pas.	<ul style="list-style-type: none"> <li>• Vérifiez que votre sealer est bien branché.</li> <li>• Assurez-vous que le commutateur soit en position "ON" (sous tension).</li> <li>• Vérifiez les fusibles et changez-les si nécessaire.</li> </ul>
Le voyant jaune d'alimentation s'allume, mais le voyant vert de marche prend plus de 20 minutes pour s'allumer ou s'éteint alors que votre sealer est en fonctionnement.	<ul style="list-style-type: none"> <li>• Appelez le service technique IDEXX ou votre distributeur local.</li> </ul>
Le moteur ne se met pas en marche quand vous insérez un Quanti-Tray.	<ul style="list-style-type: none"> <li>• Assurez-vous que votre sealer ait atteint sa température de fonctionnement et que le voyant vert soit allumé.</li> <li>• Assurez-vous que l'arrière blanc de la plaque Quanti-Tray soit tournée vers vous.</li> </ul>
Le moteur se met en marche quand vous insérez le Quanti-Tray, mais ne l'entraîne pas complètement.	<ul style="list-style-type: none"> <li>• Vérifiez que la plaque est dans le plateau de caoutchouc.</li> <li>• Assurez-vous de bien pousser le plateau de caoutchouc dans la fente, jusqu'à ce que le moteur l'entraîne.</li> <li>• Nettoyez le plateau de caoutchouc.</li> </ul>
Le Quanti-Tray et le plateau de caoutchouc sont coincés dans votre sealer.	<ul style="list-style-type: none"> <li>• APPUYEZ sur le bouton de retour et tenez-le enfoncé pour mettre en marche arrière le moteur, jusqu'à ce que le Quanti-Tray soit éjecté par la fente d'entrée. <b>NOTE</b> : Si le Quanti-Tray est complètement entré dans votre sealer, n'utilisez pas le bouton de retour, parce que cela risque de coincer le Quanti-Tray à l'intérieur. Par contre, faites sortir le plateau de caoutchouc par la fente de sortie en tirant dessus.</li> </ul>
Votre sealer émet des sifflements quand il scelle ou du liquide coule du fond de la machine.	<ul style="list-style-type: none"> <li>• Ceci fait partie de l'utilisation normale lorsque les plaques sont trop remplies. Ne remplissez pas les plaques avec plus de 100 ml d'échantillon. Le sealer est conçu pour enlever automatiquement de la plaque tout excès d'échantillon et le déverser au fond du sealer.</li> </ul>
Les Quanti-Trays se boursoufflent, ou leur papier protecteur jaunit après le scellement.	<ul style="list-style-type: none"> <li>• Appelez le service technique d'IDEXX ou votre distributeur local. Le rouleau de votre sealer chauffe peut-être trop.</li> </ul>

### GARANTIE LIMITÉE

IDEXX Laboratories, Inc. («IDEXX») garantit que ce produit est conforme aux caractéristiques décrites dans nos publications jusqu'à la date de péremption indiquée ou, en l'absence de toute mention, pendant une durée de un an à compter de la date de réception dudit produit par l'acheteur original et l'utilisateur final («Acheteur») lorsque les conditions de conservation requises sont respectées et dans des conditions normales d'utilisation conformes à l'usage auquel le produit est destiné. Pendant toute la période où cette garantie est en vigueur, IDEXX s'engage à remplacer tout produit non conforme dans les 30 jours qui suivent la date de réexpédition à IDEXX, et ce sans aucun frais pour l'Acheteur. Dans le cadre de cette garantie limitée, IDEXX ne peut en aucune façon être tenue de procéder à des échanges résultant, en totalité ou en partie, de toute catastrophe, faute ou négligence de la part de l'Acheteur ou de toute personne effectuant une réclamation pour le compte de l'Acheteur, ou de l'utilisation impropre des produits, ou encore pour des raisons indépendantes aux produits.

L'Acheteur doit notifier IDEXX de tout produit présumé non conforme pendant la période de garantie. À la discrétion d'IDEXX, lesdits produits seront retournés par l'Acheteur, frais d'envoi et d'assurance prépayés, à l'établissement désigné par IDEXX pour y être examinés et testés. IDEXX réparera ou remplacera tout produit s'avérant non conforme sous 30 jours après réception par IDEXX et retournera promptement lesdits produits à l'Acheteur, frais d'envoi et d'assurance prépayés. Dans l'éventualité où IDEXX établirait, à la suite des tests et examens nécessaires, que lesdits produits ne présentent aucune non-conformité couverte par la susdite garantie, IDEXX en notifiera l'Acheteur et détruira ou retournera les produits conformément aux instructions de l'Acheteur et aux frais de ce dernier.

**LES DISPOSITIONS DE LA SUSDITE GARANTIE LIMITÉE TIENNENT LIEU DE TOUTE AUTRE GARANTIE, QU'ELLE SOIT EXPLICITE, IMPLICITE, ÉCRITE OU VERBALE (Y COMPRIS TOUTE GARANTIE DE QUALITÉ MARCHANDE OU D'ADAPTATION À UN USAGE PARTICULIER). LA RESPONSABILITÉ D'IDEXX'S CONCERNANT LA FABRICATION, LA VENTE OU L'APPROVISIONNEMENT EN PRODUITS, DE MÊME QUE LEUR UTILISATION OU ÉLIMINATION, QUE CELA SOIT BASÉ SUR LA GARANTIE, UN CONTRAT, DES DOMMAGES-INTÉRÊTS OU AUTRE, NE PEUT EXCÉDER LE PRIX D'ACHAT RÉEL DÉBOURSÉ PAR L'ACHETEUR POUR LES PRODUITS. EN AUCUN CAS IDEXX NE PEUT ÊTRE TENUE POUR RESPONSABLE ENVERS L'ACHETEUR OU TOUTE AUTRE PERSONNE OU ENTITÉ DE TOUT DOMMAGE PARTICULIER, ACCESSOIRE, INDIRECT OU IMMATÉRIEL NI PASSIBLE DE DOMMAGES-INTÉRÊTS EXEMPLAIRES (Y COMPRIS, MAIS SANS S'Y LIMITER, LES PERTES DE PROFITS OU LA PRIVATION DE JOUISSANCE) SURVENANT POUR DES RAISONS RELEVANT DE LA FABRICATION, LA VENTE OU L'APPROVISIONNEMENT DES PRODUITS. LA SUSDITE GARANTIE EST LIMITÉE À L'ACHETEUR UNIQUEMENT ET NE PEUT S'APPLIQUER À TOUTE AUTRE PERSONNE OU ENTITÉ, Y COMPRIS, ET SANS S'Y LIMITER, LES CLIENTS DE L'ACHETEUR.**

**Service technique aux États-Unis/Canada**  
**Téléphone: 1-207-856-0496 ou 1-800-321-0207 Fax 1-207-856-0630**

Manufacturé sous un ou plusieurs du suivant brevets U.S. nos 4,925,789; 5,429,933; 5,518,892; 5,610,029; 5,620,865; 5,620,895; 5,753,456 et 5,780,259. Autres brevets américains et/ou étrangers enregistrés ou en cours d'enregistrement.  
 \*Quanti-Tray, Defined Substrate Technology, Colilert, Colisure, Enterolert et DST sont soit des marques de fabrique soit des marques déposées d'IDEXX Laboratories, Inc. aux États-Unis et/ou dans d'autres pays.

© 2002 IDEXX Laboratories, Inc.

# Manual del usuario del Sellador Quanti-Tray\* Modelo 2X

## PRECAUCION



**PRECAUCIÓN: RIESGO DE ELECTROCUCIÓN**

No abrir la tapa de este sellador.



Impedir el derrame de agua en este sellador.

Poner las muestras de agua en los Quanti-Tray, tal como se describe en las instrucciones.



**PRECAUCIÓN: RIESGO DE QUEMADURAS DE LA PIEL**

Su compañía o institución podría disponer de personal cualificado para la limpieza del interior del sellador. El personal cualificado deberá consultar las Instrucciones de mantenimiento preventivo como guía para limpiar el interior del sellador.

## Descripción

El Sellador IDEXX Quanti-Tray\* Modelo 2X es un instrumento motorizado con rodillo calentado, diseñado para sellar IDEXX Quanti-Tray\* (incluyendo Quanti-Tray\*/2000). El sellador se usa con Quanti-Tray\* y con cualquier reactivo IDEXX Defined Substrate Technology\*, como Colilert\*, Colilert\*-18, Colisure\* y Enterolert\*, para automatizar el manejo de muestras para recuento bacterial. Con esta combinación, se pueden obtener recuentos tan precisos como los obtenidos con filtración con membrana y con la facilidad de una prueba de presencia/ausencia.

Diagrama 1

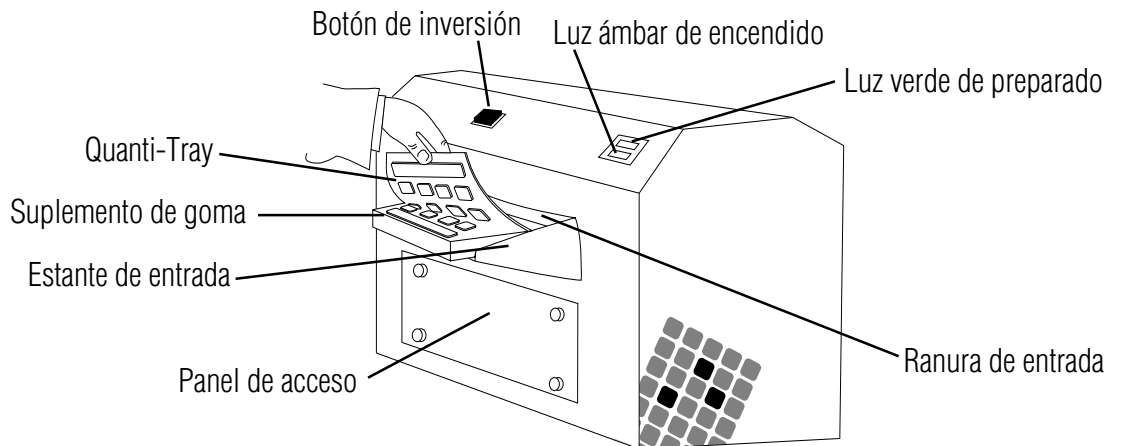
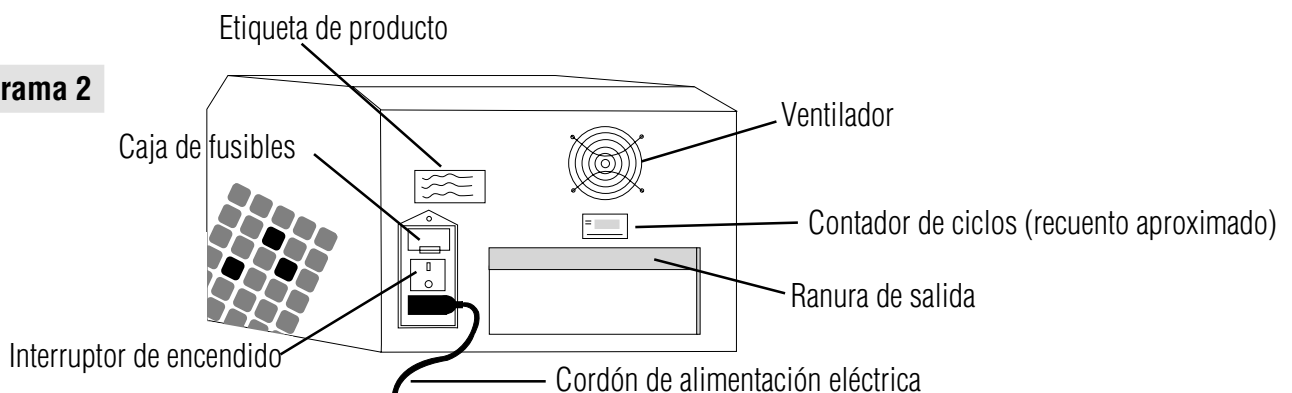


Diagrama 2



## Contenido de la unidad

Cada sellador Modelo 2X viene con la unidad selladora básica, un estante de entrada, un suplemento de goma del Quanti-Tray, tablas MPN, este Manual del usuario, y el conjunto de Instrucciones de mantenimiento preventivo. El modelo de 115 V también viene con un cordón eléctrico de 3 patas con puesta a tierra (estándar de EE.UU). El modelo de 230 V también viene con 3 cordones eléctricos para uso en: el Reino Unido, Europa (Shuko) y Suiza.

**Nota:** Los suplementos de goma de Quanti-Tray/2000 (WQTSRBR-2k) se suministran por separado. También se pueden pedir separadamente suplementos de goma adicionales de Quanti-Tray (WQTSRBR-51).

## Instalación

- Sacar el contenido del embalaje y guardar el embalaje en caso de que deba ser enviado en el futuro.
- Colocar el sellador sobre una superficie nivelada, donde haya suficiente espacio para las bandejas que deban ser introducidas y sacadas. El sellador se puede usar con cualquier orientación (izquierda a derecha o derecha a izquierda).
- Acoplar el estante de entrada al sellador, introduciendo las pestañas del estante en las dos ranuras frontales del sellador y presionando para que quede firmemente en posición.
- Verificar que el interruptor esté en posición de apagado.
- Enchufar el cordón de alimentación eléctrica en el sellador y el otro extremo en un tomacorriente con pata de puesta a tierra y el voltaje que corresponda (véase la Etiqueta del Producto).

## Instrucciones de uso

**Advertencia: Si el sellador no se usa de acuerdo con estas instrucciones, se pueden producir lesiones personales, averías al sellador, rotura de otros objetos y/o se podría perder precisión en los resultados.**

- Encender la unidad con el interruptor. La luz ámbar de encendido debe quedar iluminada.
- Dejar que el sellador se precaliente y que la luz verde de preparado se encienda, indicando que la unidad ha alcanzado la temperatura de servicio.
- Colocar un suplemento de goma de Quanti-Tray o Quanti-Tray/2000 en el estante de entrada, con la abertura grande orientada hacia el lado opuesto al sellador.
- Colocar una Quanti-Tray o Quanti-Tray/2000 llena con la muestra y reactivo DST\* sobre el suplemento de goma, verificando que quede bien asentada y con cada cavidad de la bandeja en el correspondiente agujero del suplemento de goma.
- Desplazar el suplemento de goma con la bandeja en el sellador hasta que el mecanismo motorizado lo tome y comience a empujarlo hacia el interior del sellador.
- En un período de aproximadamente 15 segundos, la bandeja será sellada y expulsada parcialmente por la parte trasera del sellador. Sacar el suplemento de goma y la bandeja por la parte trasera del sellador.
- Si, en cualquier momento dado, es necesario invertir la dirección de tracción del motor que está introduciendo el suplemento de goma en el sellador (por ejemplo, porque la bandeja se está introduciendo cruzada en el sellador), simplemente oprimir y mantener oprimido el botón de inversión. No invertir la dirección de tracción del motor una vez que el suplemento de goma esté totalmente introducido en la Ranura de Entrada.
- Se pueden introducir varios suplementos de goma en forma consecutiva y sin pausas.
- Apagar el sellador cuando no sea usado.

## Especificaciones técnicas

Peso	Dimensiones	Temperatura ambiente	Alimentación eléctrica
35 lbs	12" A x 11" L x 16" A	32-90°F	115V, 60Hz, 6Amp (model 99-10893-00)
16 kg	30cm A x 27cm L x 39cm A	0-32°C	230V, 50Hz, 3Amp (model 99-10896-00)

## Limpieza

El suplemento de goma se puede desinfectar en autoclave o también se puede limpiar con alcohol isopropílico o hipoclorito de sodio (blanqueador de uso domiciliario), tomando las precauciones necesarias para usar dichos líquidos. Limpiar bien el suplemento de goma si mostrara señales de suciedad sedimentada o pegada.

Limpiar el exterior del sellador con un paño blando y seco. También se puede usar un paño blando humedecido con agua, con hipoclorito de sodio (blanqueador) o con alcohol isopropílico, tomando las precauciones necesarias para usar dichos líquidos.

Únicamente personal capacitado de mantenimiento debe abrir el panel de acceso para limpiar el interior del sellador. El personal de mantenimiento debe consultar las Instrucciones de mantenimiento preventivo para aplicar los procedimientos de limpieza interna del sellador. **Únicamente personal capacitado debe llevar a cabo la limpieza en sus instalaciones.** No abrir el panel de acceso ni inclinar el sellador, si se notara que la muestra está goteando.

## Cambio de fusibles

Los fusibles están en el portafusible ubicado encima del interruptor de encendido. Si fuera necesario cambiar un fusible, apagar el sellador y desenchufar el cordón antes de abrir el portafusible. Usar fusibles de 6 amp. Buss MDL-6 o tipo equivalente en la unidad de 115V, y de 4 amp. Buss GDC-4 o tipo equivalente en la unidad de 230V.

## Diagnóstico de fallas

Síntoma	Medida correctiva recomendada
Luz ámbar de encendido no se ilumina.	<ul style="list-style-type: none"> <li>• Verificar que el sellador esté recibiendo alimentación eléctrica.</li> <li>• Verificar que el interruptor esté en posición de encendido.</li> <li>• Revisar los fusibles y cambiarlos si fuera necesario.</li> </ul>
Luz ámbar de encendido se ilumina, pero la luz verde de preparado tarda más de 20 minutos en iluminarse o se apaga durante el uso de la unidad.	<ul style="list-style-type: none"> <li>• Llamar a Apoyo Técnico de IDEXX o al distribuidor local de sus productos.</li> </ul>
El motor no arranca cuando se introduce una Quanti-Tray.	<ul style="list-style-type: none"> <li>• Verificar que el sellador se haya precalentado y que la luz verde esté encendida.</li> <li>• Verificar que la Quanti-Tray esté hacia abajo, apoyada sobre el suplemento de goma, con el papel blanco de fondo de la bandeja hacia arriba.</li> </ul>
El motor arranca cuando se introduce una Quanti-Tray, pero no traiciona la bandeja hacia adentro.	<ul style="list-style-type: none"> <li>• Verificar que la bandeja esté sobre el suplemento de goma.</li> <li>• Asegurarse de empujar firmemente el suplemento de goma contra el rodillo, hasta que el mecanismo motorizado lo tome.</li> <li>• Limpiar el suplemento de goma</li> </ul>
Quanti-Tray y suplemento de goma se quedan atascadas en el sellador.	<ul style="list-style-type: none"> <li>• Oprimir y MANTENER oprimido el botón de inversión del motor hasta que la bandeja sea expulsada de la ranura de entrada. <b>NOTA:</b> Si la bandeja ha entrado completamente en el sellador, no usar el botón de inversión, ya que la bandeja podría quedar atascada adentro. Tirar del suplemento de goma y sacarlo por la ranura de salida.</li> </ul>
El sellador hace un ruido silbante fuerte cuando está sellando o hay pérdida o goteo de líquido por la parte inferior del sellador.	<ul style="list-style-type: none"> <li>• Esto es normal cuando se sobrecargan las bandejas. No cargar las bandejas con más de 100 ml de muestra. El sellador está diseñado para eliminar automáticamente el exceso de muestra en la bandeja y desechar dicho exceso por la parte inferior del sellador.</li> </ul>
Después del sellamiento, la bandeja aparece ampollada o con el papel del fondo amarillento.	<ul style="list-style-type: none"> <li>• Llamar a Apoyo Técnico de IDEXX o al distribuidor local de sus productos. El rodillo del sellador podría estar trabajando a una temperatura excesivamente alta.</li> </ul>

### GARANTÍA LIMITADA

IDEXX Laboratories, Inc. ("IDEXX") garantiza que este producto cumplirá con nuestras especificaciones publicadas cuando se almacene bajo las condiciones apropiadas y se use en la forma normal, apropiada e intentada, hasta la fecha de caducidad de su vida útil declarada o, si no se declara una vida útil, durante un año desde la fecha de entrega de este producto al comprador usuario original ("Comprador"). Durante el período de la garantía correspondiente, IDEXX se compromete a reemplazar todos los productos defectuosos dentro de los 30 días después de la fecha de devolución a IDEXX y sin costo para el Comprador. Bajo esta garantía limitada, IDEXX no estará obligado a efectuar reemplazos que hayan sido el resultado, total o parcialmente, de catástrofes, fallas o negligencia del Comprador o de cualquiera que presente reclamos a través o a nombre del Comprador, o por el uso impropio de los productos o el uso de los productos de una manera para la cual no han sido diseñados, o bien, por causas externas a los productos.

El Comprador deberá notificar a IDEXX sobre cualquier producto que considere no aceptable durante el período de la garantía. A discreción de IDEXX, tales productos deberán ser devueltos por el Comprador, con el transporte y seguro pago, a las instalaciones indicadas por IDEXX para su examen y pruebas. IDEXX reparará o reemplazará, dentro de los 30 días de haber sido recibido por IDEXX, cualquier producto que se haya demostrado ser no aceptable y devolverá sin demora tales productos al Comprador, con gastos de transporte y seguros prepagos. En caso de que el examen y las pruebas hechos por IDEXX no revelen defecto alguno cubierto por la garantía anterior, IDEXX informará de esto al Comprador y desechará o devolverá el producto de acuerdo con las instrucciones del Comprador, quien será responsable de los gastos consiguientes.

**LAS PROVISIONES DE LA GARANTÍA LIMITADA ANTERIOR REEMPLAZAN CUALQUIER OTRA GARANTÍA, EXPLÍCITA O IMPLÍCITA, EMITIDA POR ESCRITO U ORALMENTE (INCLUSO CUALQUIER GARANTÍA DE COMERCIABILIDAD O PERTINENCIA PARA UN FIN EN PARTICULAR). LA RESPONSABILIDAD DE IDEXX QUE SURJA DE LA FABRICACIÓN, VENTA O ABASTECIMIENTO DE LOS PRODUCTOS, SU USO O SU DISPOSICIÓN, SEA QUE SE BASEN EN GARANTÍAS, CONTRATOS, AGRAVIOS U OTROS, NO EXCEDERÁ EL PRECIO DE COMPRA REAL PAGADO POR EL COMPRADOR POR LOS PRODUCTOS. EN NINGÚN CASO SERÁ IDEXX RESPONSABLE ANTE EL COMPRADOR O CUALQUIER OTRA PERSONA O ENTIDAD, POR DAÑOS ESPECIALES, INCIDENTALES, CONSIGUIENTES, INDIRECTOS O PUNITIVOS (CON INCLUSIÓN, ENTRE OTROS, DE DAÑOS POR PÉRDIDAS DE GANANCIAS O PÉRDIDA DE USO) QUE SURJAN DE LA MANUFACTURA, VENTA O ABASTECIMIENTO DE LOS PRODUCTOS. LAS GARANTÍAS MENCIONADAS SE EXTIENDEN SOLAMENTE AL COMPRADOR Y NO SE APLICARÁN A NINGUNA OTRA PERSONA O ENTIDAD, CON INCLUSIÓN Y SIN LIMITARSE A LOS CLIENTES DEL COMPRADOR.**

**Apoyo Técnico de IDEXX en EE.UU./Canadá**  
**Teléfono 1-207-856-0496 o 1-800-321-0207 Fax 1-207-856-0630**

Fabricado bajo una o más de las patentes siguientes de los E.U. 4,925,789; 5,429,933; 5,518,892; 5,610,029; 5,620, 865; 5,620,895; 5,753,456 y 5,780,259. Otras patentes norteamericanas y/o extranjeras concedidas o pendientes de concesión.  
 \*Quanti-Tray, Defined Substrate Technology, Colilert, Colisure, Enterolert y DST son marcas o marcas registradas de IDEXX Laboratories, Inc. en los Estados Unidos de America y/o en otros países.

© 2002 IDEXX Laboratories, Inc.

# Sigillatrice IDEXX Quanti-Tray\* Modello 2X Manuale d'uso

## ATTENZIONE



### ATTENZIONE: PERICOLO DI SCARICHE ELETTRICHE

Non aprire il coperchio della sigillatrice.

Evitare le infiltrazioni d'acqua nella sigillatrice.



Versare i campioni d'acqua nella vaschetta Quanti-Tray seguendo la procedura descritta nell'inserito Quanti-Tray.



### ATTENZIONE: PERICOLO DI USTIONI

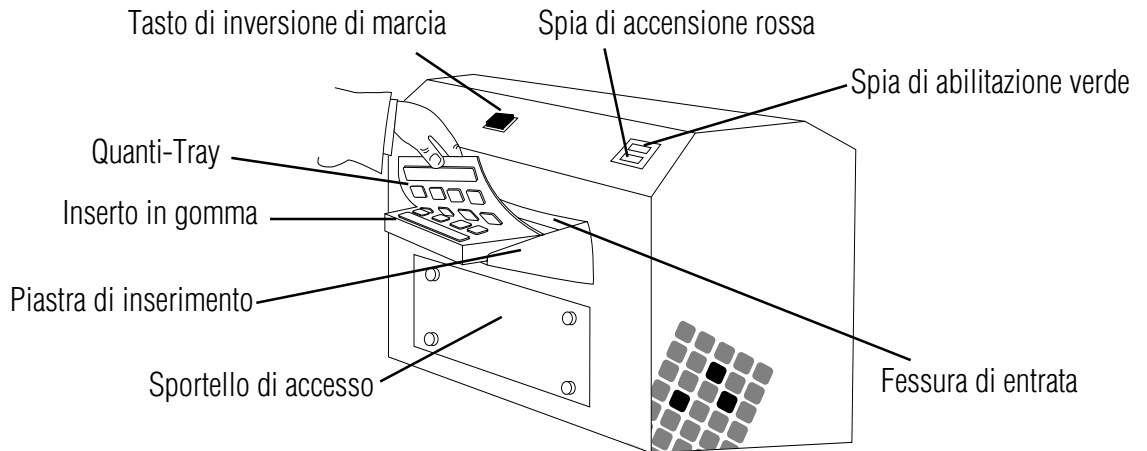
La vostra azienda può preparare del personale specificamente per le operazioni di pulitura all'interno della sigillatrice. Il personale qualificato dovrà consultare le istruzioni per la manutenzione preventiva per informazioni su come pulire l'interno della sigillatrice.



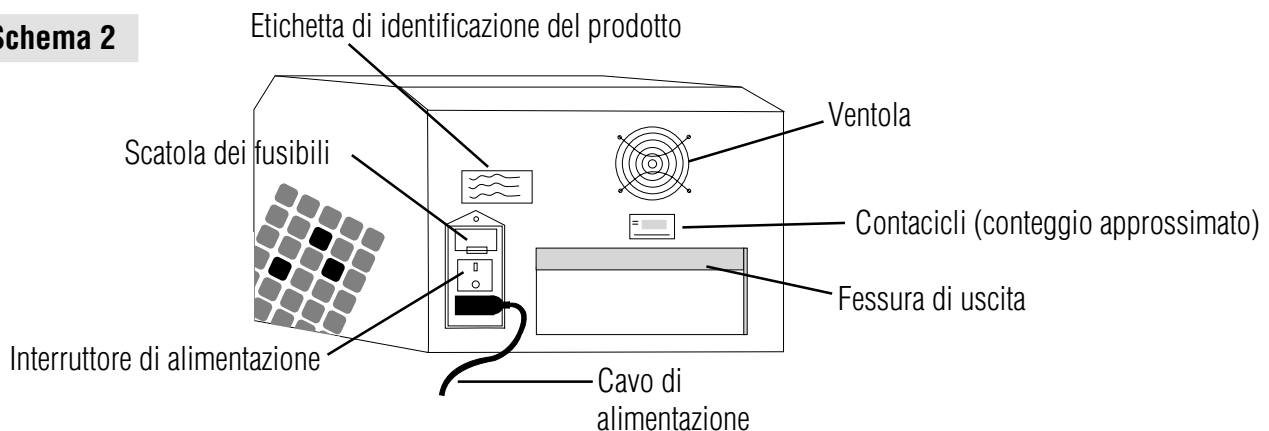
## Descrizione

La Sigillatrice IDEXX Quanti-Tray\* Modello 2X è un apparecchio motorizzato a rullo termico che serve per sigillare le vaschette IDEXX Quanti-Tray\* (comprese le vaschette Quanti-Tray\*/2000). Questo apparecchio, che utilizza vaschette Quanti-Tray\* e qualsiasi tipo di reagente a tecnologia IDEXX Defined Substrate Technology\*, come Colilert\*, Colilert\*-18, Colisure\* ed Enterolert\*, automatizza il processo di gestione dei campioni per la conta batterica. Insieme, questi strumenti forniscono una conta tanto accurata quanto quella offerta dal metodo della filtrazione a membrana, con il vantaggio delle prove di presenza/assenza.

### Schema 1



### Schema 2



## Contenuto della confezione

Tutte le confezioni della Sigillatrice Modello 2X contengono una sigillatrice, una piastra di inserimento, un inserto in gomma Quanti-Tray, le tabelle MPN, il presente manuale d'uso e le istruzioni per la manutenzione preventiva. Il modello da 115 V è dotato di cavo tripolare standard U.S.A. con polo di messa a terra. Il modello da 230 V è dotato di 3 cavi di alimentazione: un cavo per la Gran Bretagna, un cavo europeo/Shuko e un cavo per la Svizzera.

**N.B.:** gli inserti in gomma Quanti-Tray/2000 (WQTSRBR-2k) sono disponibili separatamente. Si possono ordinare separatamente anche inserti in gomma aggiuntivi Quanti-Tray (WQTSRBR-51).

## Installazione

- Aprire la confezione e conservarla per future esigenze di trasporto.
- Collocare la sigillatrice su una superficie piana, lasciando spazio sufficiente per l'inserimento e l'estrazione delle vaschette. La sigillatrice può essere orientata in qualsiasi direzione (da sinistra a destra o viceversa).
- Fissare la piastra di inserimento alla sigillatrice inserendo le linguette nelle due apposite fessure sul pannello anteriore della sigillatrice, assicurandosi che siano agganciate saldamente.
- Assicurarsi che l'interruttore di alimentazione sia spento.
- Collegare il cavo di alimentazione alla sigillatrice e inserire la spina in una presa di corrente alimentata alla tensione opportuna (vedere l'etichetta del prodotto) e dotata di presa di terra.

## Istruzioni d'uso

**Attenzione: l'uso della sigillatrice in modo non conforme alle presenti istruzioni può provocare infortuni, danni alla sigillatrice e ad altri oggetti e risultati imprecisi nei test.**

- Accendere l'interruttore di alimentazione: la spia di accensione si illumina.
- Dar tempo alla sigillatrice di scaldarsi e attendere che si accenda la spia verde di abilitazione (possono trascorrere fino a dieci minuti). La sigillatrice non funzionerà fino a quando entrambe le spie, quella rossa di accensione e quella verde di abilitazione, non si saranno accese a indicare che l'apparecchio ha raggiunto la temperatura di esercizio necessaria.
- Collocare un inserto in gomma vuoto Quanti-Tray o Quanti-Tray/2000 sulla piastra di inserimento in modo che l'ampia porzione ritagliata dell'inserto corrisponda all'estremità della piastra più lontana dalla sigillatrice.
- Preparare una vaschetta Quanti-Tray o Quanti-Tray/2000 con campioni e reagente DST\* e collocarla sull'inserto in gomma, assicurandosi che la vaschetta sia alloggiata correttamente e che tutti i pozzetti della vaschetta siano ben inseriti nei fori corrispondenti dell'inserto in gomma.
- Far scivolare l'inserto in gomma con la piastra all'interno della sigillatrice finché il motore non afferra l'inserto e non comincia a tirarlo all'interno della sigillatrice.
- Trascorsi quindici secondi circa, la vaschetta sarà sigillata e fuoriuscirà in parte sul retro della sigillatrice. Rimuovere l'inserto in gomma e la vaschetta dal retro dell'apparecchio.
- Se per qualsiasi motivo si volesse invertire la direzione di marcia del motorino che trascina l'inserto di gomma nella sigillatrice (perché, ad esempio, si è spinta una vaschetta mal allineata all'interno della sigillatrice), si può premere e tenere il tasto di inversione di marcia. Tuttavia, questa operazione va evitata se l'inserto in gomma è già stato trascinato interamente nella fessura di entrata.
- È possibile inserire diversi inserti in gomma consecutivamente senza interruzione.
- Quando non è in funzione, la sigillatrice va spenta.

## Caratteristiche tecniche

Peso	Dimensioni (in cm)	Temperatura ambiente	Alimentazione
35 lbs	12" Alt. x 11" Pro. x 16" Lar.	32-90°F	115V, 60Hz, 6Amp (modello 99-10893-00)
16 kg	30cm Alt. x 27cm Pro. x 39cm Lar.	0-32°C	230V, 50Hz, 3Amp (modello 99-10896-00)

## Pulizia

L'inserto in gomma può essere sterilizzato in autoclave o pulito con alcol isopropilico o candeggina, prendendo le precauzioni necessarie per l'uso di detti prodotti. Aver cura di pulire l'inserto in gomma se presenta un accumulo di sporco.

Per la pulizia della parte esterna della sigillatrice usare un panno soffice e asciutto. Si può anche utilizzare un panno soffice inumidito con acqua, candeggina o alcol isopropilico, prendendo le precauzioni necessarie per l'uso di dette sostanze.

Lo sportello di accesso va aperto esclusivamente da personale qualificato per la pulitura all'interno della sigillatrice. Per informazioni su come pulire l'interno della sigillatrice, consultare le istruzioni per la manutenzione preventiva. **La pulitura va eseguita esclusivamente da personale preparato presso il proprio sito operativo.** Non aprire lo sportello di accesso e non capovolgere la sigillatrice se il campione cola dall'unità.

## Sostituzione dei fusibili

I fusibili si trovano nella scatola dei fusibili situata sopra l'interruttore di alimentazione. Se occorre sostituire un fusibile, spegnere la sigillatrice e disinserire il cavo di alimentazione dalla sigillatrice prima di aprire la scatola dei fusibili. Utilizzare fusibili Buss MDL-6 da sei ampere, o equivalenti, per il modello a 115 Volt e fusibili Buss GDC-4 da quattro ampere, o equivalenti, per il modello a 230 Volt.

## Diagnostica

Sintomo	Rimedio suggerito
La spia rossa di accensione non si accende.	<ul style="list-style-type: none"> <li>• Verificare che la sigillatrice sia collegata a una presa alimentata.</li> <li>• Assicurarsi di aver acceso l'interruttore di alimentazione.</li> <li>• Controllare i fusibili e sostituirli se necessario.</li> </ul>
La spia rossa di accensione si accende ma trascorrono oltre venti minuti prima che la spia verde di abilitazione si accenda; oppure la spia di abilitazione si spegne durante il funzionamento.	<ul style="list-style-type: none"> <li>• Contattare il servizio di assistenza tecnica IDEXX o il rivenditore locale.</li> </ul>
Quando si inserisce una vaschetta Quanti-Tray il motorino non si avvia.	<ul style="list-style-type: none"> <li>• Assicurarsi che la sigillatrice si sia scaldata e che la spia verde di abilitazione sia accesa.</li> <li>• Verificare che la vaschetta Quanti-Tray si trovi rivolta verso il basso nell'inserito di gomma, con il rivestimento bianco della vaschetta rivolto verso l'alto.</li> </ul>
Il motore si avvia quando si inserisce una vaschetta Quanti-Tray, ma non riesce a trascinare completamente la vaschetta.	<ul style="list-style-type: none"> <li>• Accertarsi che la piastra si trovi nell'inserito in gomma.</li> <li>• Spingere fino in fondo l'inserito in gomma contro il rullo, finché il motore non fa presa.</li> <li>• Pulire l'inserito in gomma.</li> </ul>
La vaschetta Quanti-Tray e l'inserito in gomma si inceppano nella sigillatrice.	<ul style="list-style-type: none"> <li>• Premere e TENERE PREMUTO il tasto di inversione di marcia per invertire la direzione del motore fino a quando la vaschetta non viene espulsa dalla fessura di entrata. <b>N.B.:</b> se la vaschetta è stata trascinata interamente all'interno della sigillatrice, non usare il tasto di inversione di marcia, per evitare che la vaschetta si incastri all'interno della sigillatrice. Estrarre invece l'inserito in gomma dalla fessura di uscita.</li> </ul>
La sigillatrice emette un sibilo acuto durante l'operazione di sigillatura o presenta una perdita di fluido dal fondo.	<ul style="list-style-type: none"> <li>• Questo fa parte del funzionamento regolare quando le piastre sono eccessivamente piene. Non versare più di 100 ml di campione nelle piastre. La sigillatrice è concepita per eliminare automaticamente il campione in eccesso ed eliminarlo nella sua parte inferiore.</li> </ul>
Le vaschette presentano bolle, oppure la carta di rivestimento è ingiallita dopo l'operazione di sigillatura.	<ul style="list-style-type: none"> <li>• Contattare il servizio di assistenza tecnica IDEXX o il rivenditore locale. Il rullo della sigillatrice potrebbe essersi surriscaldato.</li> </ul>

### GARANZIA LIMITATA

La IDEXX Laboratories, Inc. ("IDEXX") garantisce che i suoi prodotti saranno conformi alle specifiche pubblicate, se conservati in condizioni adeguate e usati nel modo normale, adeguato e inteso, fino alla data di conservazione indicata, oppure, se non è indicata alcuna data, per un periodo di un anno dalla data di consegna del prodotto all'originale utente finale che lo ha acquistato ("Acquirente"). La IDEXX, durante il periodo di garanzia applicabile, concorda di sostituire tutti i prodotti non conformi entro 30 giorni dalla data di restituzione alla IDEXX stessa e senza alcun addebito per l'Acquirente. La IDEXX non avrà alcun obbligo, secondo i termini di questa garanzia limitata, di effettuare sostituzioni di prodotti i cui difetti derivano, in toto o in parte, da catastrofe, colpa o negligenza dell'Acquirente, o di qualsiasi persona che presenti reclamo attraverso o a nome dell'Acquirente, oppure risultanti da un uso improprio dei prodotti, o l'uso dei prodotti in modi per cui i prodotti non sono stati progettati, o per cause esterne ai prodotti.

L'Acquirente avvertirà la IDEXX di qualsiasi prodotto che ritiene essere non conforme durante il periodo di garanzia. Ad opzione della IDEXX, tali prodotti verranno restituiti dall'Acquirente, con spese di trasporto e assicurazione prepagate, alla struttura IDEXX designata per l'ispezione e la prova. La IDEXX riparerà o rimpiazzerà, entro 30 giorni dalla sua ricezione, qualsiasi prodotto di tal genere trovato essere non conforme, e restituirà prontamente tale prodotto all'Acquirente, con spese di trasporto e assicurazione prepagate. Se l'ispezione e la prova da parte della IDEXX non dovesse riscontrare la mancanza di conformità coperto dalla presente garanzia, la IDEXX ne notificherà l'Acquirente ed eliminerà o rispedirà il prodotto a sole spese dell'Acquirente.

**LE CLAUSOLE DELLA PRESENTE GARANZIA LIMITATA SOSTITUISCONO QUALSIASI ALTRA GARANZIA, ESPRESSA O IMPLICITA, SCRITTA OD ORALE (COMPRESSE EVENTUALI GARANZIE DI COMMERCIALIZZABILITÀ O IDONEITÀ AD UNO SCOPO PARTICOLARE). LA RESPONSABILITÀ DELLA IDEXX DERIVANTE DALLA FABBRICAZIONE, DALLA VENDITA O DALLA FORNITURA DEI PRODOTTI, O DAL LORO USO O ELIMINAZIONE, BASATA SU GARANZIA, CONTRATTO, TORTO O ALTRO, NON SUPERERÀ IL PREZZO DI ACQUISTO EFFETTIVO PAGATO DALL'ACQUIRENTE PER I PRODOTTI. IN NESSUN CASO LA IDEXX SARÀ RESPONSABILE NEI CONFRONTI DELL'ACQUIRENTE O DI QUALSIASI ALTRA PERSONA O ENTITÀ PER QUANTO RIGUARDA DANNI SPECIALI, INCIDENTALI, DERIVATI, INDIRETTI O ESEMPLARI (INCLUSI, SENZA LIMITARSI AD ESSI, LA PERDITA DI PROFITTI O I DANNI DERIVATI DALLA PERDITA DI USO) DERIVANTI DALLA FABBRICAZIONE, DALLA VENDITA O DALLA FORNITURA DEI PRODOTTI. LE PRESENTI GARANZIE SI ESTENDONO ESCLUSIVAMENTE ALL'ACQUIRENTE E NON PERTERRANNO A NESSUN'ALTRA PERSONA O ENTITÀ COMPRESI, SENZA LIMITARSI AD ESSI, I CLIENTI DELL'ACQUIRENTE.**

**IDEXX US/Canada Assistenza tecnica**  
**Telefono 1-207-856-0496 o 1-800-321-0207**  
**Fax 1-207-856-0630**

Prodotto sotto uno o più di seguenti brevetti USA n. 4,925,789; 5,429,933; 5,518,892; 5,610,029; 5,620,865; 5,620,895; 5,753,456 e 5,780,259. Altri brevetti degli U.S.A. e/o stranieri concessi o domate di brevetto degli U.S.A. e/o stranieri pendenti.

\*Quanti-Tray, Defined Substrate Technology, Colilert, Colisure, Enterolert e DST sono marchi di proprietà di, e/o registrati da, IDEXX Laboratories, Inc. e protetti negli Stati Uniti e/o in altri paesi.

© 2002 IDEXX Laboratories, Inc.

# Quanti-Tray\* Versiegelungsgerät Modell 2X Benutzeranleitung

## VORSICHT



### **VORSICHT! STROMSCHLAGGEFAHR!**

Den Deckel des Versiegelungsgerätes nicht öffnen.

Das Versiegelungsgerät darf nicht naß werden.



Die Wasserproben wie im Quanti-Tray-Beipackzettel beschrieben in die Quanti-Trays füllen.



### **VORSICHT! VERBRENNUNGSGEFAHR!**

Ihr Unternehmen bzw. Ihre Einrichtung sollte erwägen, Personal speziell in der Reinigung der Innenflächen des Geräts zu schulen. Das qualifizierte Personal wird auf die Serviceanleitung verwiesen, die die Reinigungsanleitung für die Innenflächen des Versiegelungsgeräts enthält.

## Beschreibung

Das Versiegelungsgerät IDEXX Quanti-Tray\*, Modell 2X ist ein aufheizbares Rollengerät mit Motorantrieb, das zur Versiegelung der IDEXX Quanti-Trays (einschließlich Quanti-Tray\*/2000s) vorgesehen ist. Dieses Versiegelungsgerät, das zusammen mit Quanti-Trays und beliebigen Reagensen von IDEXX Defined Substrate Technology\* wie z.B. Colilert\*, Colilert\*-18, Colisure\* und Enterolert\* verwendet wird, automatisiert die Probenbehandlung bei Bakterienzählungen. Zusammen erbringen sie Ergebnisse, die so genau wie die der Membranfiltration, aber so einfach sind wie ein Nachweistest.

Diagramm 1

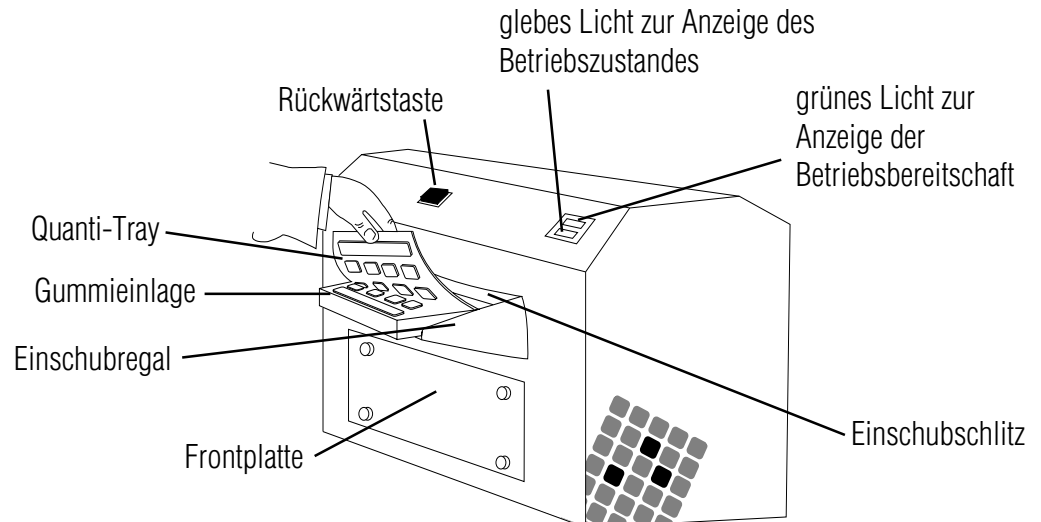
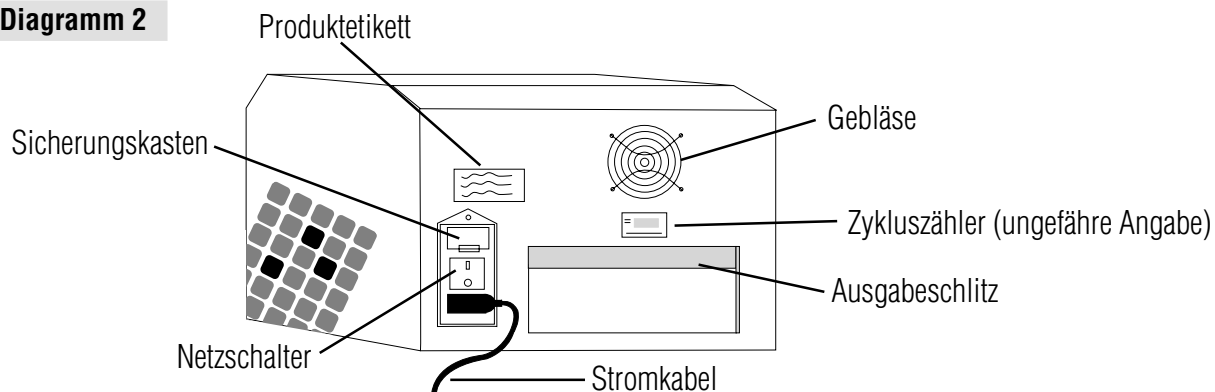


Diagramm 2



## Lieferumfang

Zum Lieferumfang jedes Versiegelungsgeräts Modell 2X gehören das Grundgerät, ein Einschubregal, eine Quanti-Tray Gummieinlage, MPN-Tabellen, diese Benutzeranleitung und Serviceanleitung. Das 115V-Modell umfasst ferner ein dreipoliges US-Norm-Kabel. Das 230V-Modell wird auch mit den folgenden drei Kabeln geliefert: je ein Kabel nach GB-, europäischer (Schuko) und Schweizer Norm.

**Hinweis:** Die Gummieinlagen für Quanti-Tray/2000 (WQTSRBR-2k) sind auch gesondert erhältlich. Gummieinlagen für Quanti-Tray (WQTSRBR-51) können ebenfalls nachbestellt werden.

## Aufstellen des Gerätes

- Das Gerät auspacken und das Verpackungsmaterial aufbewahren.
- Das Versiegelungsgerät auf einer ebenen Fläche aufstellen. Dabei sollte genügend Platz vorhanden sein, daß die Trays eingeschoben und ausgestoßen werden können. Das Versiegelungsgerät kann für eine beliebige Richtung ausgerichtet werden (links nach rechts bzw. rechts nach links).
- Nun das Einschubregal durch Einlegen der Stifte am Regal in die zwei Schlitze vorne am Versiegelungsgerät montieren und fest ankleben.
- Der Netzschalter muß ausgeschaltet sein.
- Das Kabel zunächst in das Versiegelungsgerät und dann in die entsprechende geerdete Steckdose einstecken. (s. Produktetikett).

## Betriebsanleitung

**Achtung: Bei unsachgemäßem Gebrauch des Versiegelungsgeräts besteht Verletzungsgefahr, Gefahr von Schäden am Versiegelungsgerät oder sonstiger Schäden im Arbeitsumfeld und/oder Gerät erbringt ungenaue Testergebnisse.**

- Den Netzschalter einschalten. Das gelbe Licht zur Anzeige des Betriebszustandes muß aufleuchten.
- Das Versiegelungsgerät aufwärmen lassen bis das grüne Licht zur Anzeige der Betriebsbereitschaft aufleuchtet (max. 10 min.). Das Versiegelungsgerät ist erst dann betriebsbereit, wenn sowohl das gelbe als auch das grüne Licht aufleuchten und damit anzeigen, daß das Gerät die Betriebstemperatur erreicht hat.
- Eine leere Quanti-Tray- bzw. Quanti-Tray/2000-Gummieinlage in das Einschubregal einlegen, wobei der große Ausschnitt vom Versiegelungsgerät weg zeigen muß.
- Anschließend ein mit Proben und DST\* Reagens gefülltes Quanti-Tray bzw. Quanti-Tray/2000 auf die Gummieinlage legen, wobei das Tray fest auf der Gummieinlage aufliegen, und jede Vertiefung im entsprechenden Loch in der Gummieinlage plaziert sein muß.
- Die Gummieinlage mit dem Tray in das Versiegelungsgerät einschieben, bis der Motor sie greift und in das Gerät einzieht.
- Das Tray wird innerhalb von 15 Sekunden versiegelt und teilweise hinten am Versiegelungsgerät wieder ausgeworfen. Die Gummieinlage und das Tray von der Rückseite des Versiegelungsgerätes aus entfernen.
- Sollte es notwendig sein, den Motor rückwärts laufen zu lassen während die Gummieinlage in das Versiegelungsgerät eingezogen wird (z.B. wenn ein falsch ausgerichtetes Tray in das Versiegelungsgerät eingeführt wird), dann einfach die Rückwärtstaste gedrückt halten. Dies darf jedoch nicht geschehen, wenn der Motor die Gummieinlage bereits vollständig in den Einschubschlitz eingezogen hat.
- Es können mehrere Gummieinlagen nacheinander ohne Unterbrechung eingegeben werden.
- Das Versiegelungsgerät bei Nichtgebrauch ausschalten.

## Technische Daten

Gewicht	Abmessungen	Umgebungstemperatur	Stromversorgung
35 lbs	12" H x 11" T x 16" B	32-90°F	115V, 60Hz, 6Amp (Modell 99-10893-00)
16 kg	30cm H x 27cm T x 39cm B	0-32°C	230V, 50Hz, 3Amp (Modell 99-10896-00)

## Reinigung

Die Gummieinlage kann autoklaviert oder mit Isopropylalkohol oder einfacher Haushaltsbleiche unter Einhaltung der üblichen Sicherheitsvorkehrungen für solche Mittel gereinigt werden. Die Gummieinlage muß gereinigt werden, sobald Ablagerungen sichtbar werden.

Die Außenseite des Versiegelungsgerätes mit einem weichen, trockenen Tuch reinigen. Es ist auch möglich, ein weiches, mit Wasser, Haushaltsbleiche oder Isopropylalkohol getränktes Tuch unter Einhaltung der üblichen Sicherheitsvorkehrungen für solche Mittel zu verwenden.

Die Frontplatte darf nur von Personal geöffnet werden, das in der Reinigung der Innenflächen des Geräts geschult wurde. Die Serviceanleitung enthält die Reinigungsanleitung für die Innenflächen des Versiegelungsgeräts. **Die Reinigung des Geräts sollte nur von speziell geschultem Personal an Ihrer Einrichtung vorgenommen werden.** Die Frontplatte darf nicht entfernt und das Versiegelungsgerät nicht gekippt werden, wenn Probeflüssigkeit vom Gerät tropft.

## Auswechseln der Sicherungen

Die Sicherungen befinden sich im Sicherungskasten über dem Netzschalter. Sollte es notwendig sein, eine Sicherung auszuwechseln, das Versiegelungsgerät vor dem Öffnen des Sicherungskastens abschalten und das Kabel aus dem Gerät abziehen. Für das 115 Volt-Gerät müssen 6 Amp Buss MDL-6 oder gleichwertige Sicherungen, für das 230 Volt-Gerät müssen 4 Amp Buss GDC-4 oder gleichwertige Sicherungen verwendet werden.

## Fehlersuche- und behebung

Problem	Lösung
Das gelbe Licht leuchtet nicht auf.	<ul style="list-style-type: none"> <li>• Sicherstellen, daß dem Netzstecker Strom zugeführt wird.</li> <li>• Sicherstellen, daß der Netzschalter eingeschaltet ist.</li> <li>• Die Sicherungen überprüfen und, falls notwendig, auswechseln.</li> </ul>
Das gelbe Licht leuchtet auf, aber das grüne Licht zur Anzeige der Betriebsbereitschaft braucht mehr als 20 Sekunden, um aufzuleuchten bzw. erlischt während des Betriebs.	<ul style="list-style-type: none"> <li>• Wenden Sie sich an die technische Unterstützung von IDEXX oder an Ihren örtlichen Vertriebs Händler.</li> </ul>
Der Motor startet nicht, wenn ein Quanti-Tray eingelegt wird.	<ul style="list-style-type: none"> <li>• Sicherstellen, daß das Versiegelungsgerät aufgewärmt ist und das grüne Licht zur Anzeige der Betriebsbereitschaft leuchtet.</li> <li>• Sicherstellen, daß das Quanti-Tray richtig auf der Gummieinlage aufliegt und die weiße Rückseite des Trays nach oben zeigt.</li> </ul>
Der Motor startet wenn das Quanti-Tray eingelegt wird, zieht das Tray aber nicht ein.	<ul style="list-style-type: none"> <li>• Darauf achten, dass das Tray in der Gummieinlage aufliegt.</li> <li>• Sicherstellen, daß die Gummieinlage fest in die Rollen eingelegt ist bis der Motor sie einzieht.</li> <li>• Die Gummieinlage reinigen.</li> </ul>
Quanti-Tray und Bummieinlage bleiben im Versiegelungsgerät stecken.	<ul style="list-style-type: none"> <li>• Die Rückwärtstaste gedrückt HALTEN bis der Motor rückwärts läuft und das Tray durch den Einschubschlitz auswirft. <b>HINWEIS:</b> Ist das Tray bereits vollständig in das Versiegelungsgerät eingezogen, darf die Rückwärtstaste nicht mehr benutzt werden, da sonst die Möglichkeit besteht, daß sich das Tray im Versiegelungsgerät verklemmt. Ist das Tray bereits vollständig eingezogen, die Gummieinlage durch den Ausgabeschlitz ziehen.</li> </ul>
Versiegelungsgerät gibt laute Zischlaute während des Versiegelungsvorgangs von sich oder Flüssigkeit tropft unten aus dem Gerät.	<ul style="list-style-type: none"> <li>• Das ist normal, wenn die Trays zu voll sind. Höchstens 100 ml Probeflüssigkeit in die Trays füllen. Das Versiegelungsgerät ist so ausgelegt, dass es automatisch überschüssige Probeflüssigkeit aus dem Tray entfernt und diese dann nach unten im Gerät abgibt.</li> </ul>
Die Trays zeigen Blasen auf oder die Rückenbeschichtung aus Papier ist nach dem Versiegelungsvorgang gelb.	<ul style="list-style-type: none"> <li>• Wenden Sie sich an die technische Unterstützung von IDEXX oder an Ihren örtlichen Vertriebs Händler. Die Temperatur der heißen Rollen des Versiegelungsgerätes ist wahrscheinlich zu hoch.</li> </ul>

### INGESCHRÄNKTE GARANTIE

IDEXX Laboratories, Inc. („IDEXX“) garantiert, dass dieses Produkt bis zum aufgedruckten Haltbarkeitsdatum oder, wenn kein solches Verfallsdatum angegeben ist, bis zu einem Jahr ab Datum der Lieferung dieses Produkts an den Original-Endverbraucher/Käufer („Käufer“) den angegebenen Spezifikationen entspricht, wenn es unter den vorgeschriebenen Bedingungen gelagert wird und für den normalen, vorgesehenen Verwendungszweck verwendet wird. IDEXX erklärt sich während der anwendbaren Garantiezeit bereit, Produkte, die nicht den angegebenen Spezifikationen entsprechen, innerhalb von 30 Tagen nach dem Datum der Rückgabe an IDEXX ohne Kosten für den Käufer zu ersetzen. IDEXX ist im Rahmen dieser eingeschränkten Garantie nicht zu Ersatzleistungen verpflichtet, die sich ganz oder teilweise aus Katastrophen, Fehlern oder Fahrlässigkeit des Käufers oder aus Ansprüchen durch Vermittlung oder im Namen des Käufers oder aus einer falschen oder nicht der Zweckbestimmung entsprechenden Verwendung des Produkts oder aus produktexternen Ursachen ergeben.

Der Käufer ist verpflichtet, IDEXX über Produkte in Kenntnis zu setzen, die während der Garantiezeit mutmaßlich nicht den angegebenen Spezifikationen entsprechen. Nach Ermessen von IDEXX sind solche Produkte vom Käufer an die designierte Einrichtung zwecks Prüfung und Test einzusenden. Die Transport- und Versicherungskosten sind im Voraus zu entrichten. Wenn sich das Produkt bei der Prüfung als nicht den angegebenen Spezifikationen entsprechend erweist, wird es von IDEXX innerhalb von 30 Tagen nach Eingang bei IDEXX repariert oder ersetzt und dem Käufer unverzüglich unter Vorauszahlung der Transport- und Versicherungskosten zugestellt. Sollte die von IDEXX durchgeführte Prüfung und der Test keine durch die oben beschriebene Garantie abgedeckte Nichtentsprechung der angegebenen Spezifikationen ergeben, wird der Käufer dahingehend informiert und das Produkt entsorgt oder gemäß den Anweisungen des Käufers auf Kosten des Käufers zurückgesandt.

**DIE BESTIMMUNGEN DER OBEN BESCHRIEBENEN INGESCHRÄNKTEN GARANTIE GELTEN ANSTELLE ANDERER AUSDRÜCKLICHER ODER STILLSCHWEIGENDER, SCHRIFTLICHER ODER MÜNDLICHER GARANTIE (EINSCHLIEßLICH ZUSICHERUNG ALLGEMEINER GEBRAUCHSTAUGLICHKEIT ODER EIGNUNG FÜR EINEN BESTIMMTEN ZWECK). DIE HAFTUNG SEITENS IDEXX, DIE AUS DER HERSTELLUNG, DEM VERKAUF ODER DER LIEFERUNG DER PRODUKTE ODER IHRER VERWENDUNG BZW. VERFÜGUNG ENTSTEHT, OB AUF DER GRUNDLAGE VON GARANTIE, VERTRAG, SCHADENSERSATZRECHT ODER EINER ANDEREN GRUNDLAGE, GEHT NICHT ÜBER DEN TATSÄCHLICHEN, VOM KÄUFER FÜR DAS PRODUKT GEZAHLTEN KAUFFREIS HINAUS. IN KEINEM FALL IST IDEXX DEM KÄUFER ODER EINER ANDEREN PERSON ODER JURISTISCHEN PERSON GEGENÜBER HAFTBAR FÜR SONDER-, NEBEN-, FOLGE-, INDIREKTE ODER ÜBER DEN VERURSACHTEN SCHADEN HINAUSGEHENDE SCHÄDEN (EINSCHLIEßLICH, OHNE AUF DIESE BESCHRÄNKT ZU SEIN, SCHÄDEN DURCH ENTGANGENE GEWINNE ODER ENTGANGENEN NUTZEN), DIE SICH AUS DER HERSTELLUNG, DEM VERKAUF ODER DER LIEFERUNG DER PRODUKTE ERGEBEN. DIE VORSTEHENDEN GARANTIE ERSTRECKEN SICH NUR AUF DEN KÄUFER UND GELTEN FÜR KEINE ANDERE PERSON ODER JURISTISCHE PERSON, EINSCHLIEßLICH UND OHNE EINSCHRÄNKUNG, KUNDEN DES KÄUFERS.**

**IDEXX/US Technische Unterstützung**  
**Telefon 1-207-856-0496 oder 1-800-321-0207 Fax 1-207-856-0630**

Hergestellt unter einem oder mehr der folgenden US-Patente 4,925,789; 5,429,933; 5,518,892; 5,610,029; 5,620,865; 5,620,895; 5,753,456 und 5,780,259. Andere U.S. und/oder ausländische Patente erteilt oder angemeldet. \*Quanti-Tray, Defined Substrate Technology, Colilert, Colisure, Enterolert und DST sind entweder Schutzmarken oder eingetragene Schutzmarken von IDEXX Laboratories, Inc. in den Vereinigten Staaten und/oder in anderen Ländern.

© 2002 IDEXX Laboratories, Inc.



**STANDARD OPERATING PROCEDURE**  
**MAINE VOLUNTEER RIVER MONITORING PROGRAM**  
**METHODS FOR USING THE YSI PROFESSIONAL PLUS**  
**HANDHELD METER IN RIVERS AND STREAMS**



**Note:** The mention of brand names does not constitute recommendation of a specific company.





## Volunteer River Monitoring Program (VRMP)

### Standard Operating Procedure Methods for using the YSI Professional Plus Handheld Meter

**1. Applicability.** This standard operating procedure (SOP) is used by the Volunteer River Monitoring Program (VRMP) of the Maine Department of Environmental Protection’s Division of Watershed Management. It applies to the collection of dissolved oxygen (DO) and temperature from rivers and streams in Maine using the YSI Professional Plus handheld meter.

**2. Purpose.** This purpose of this SOP is to provide standardized methods for volunteer groups to determine dissolved oxygen of rivers and streams by volunteers as an instantaneous reading using the YSI Professional Plus handheld meter.

#### 3. Definitions.

**A. YSI.** Yellow Springs International, manufacturer of water quality monitoring meters.

**B. Sensor.** Electrode sensing portion of the cable assembly.

**C. O2 solution.** Electrolyte solution used to fill the probe.

**D. Calibration.** Set of procedures established by the manufacturer to ensure that the meter is operating properly; a critical quality assurance step in meter preparation prior to use.

**E. Membrane.** A clear, transparent and paper-thin substance similar to cellophane on the end of the probe. The membrane is permeable and allows gases such as oxygen to pass through into probe sensors while at the same time isolating most other undesirable substances.

**F. Jigging.** To move the probe under water using steady movements. Unless the probe is being held in swiftly flowing water, the probe shall be moved (“jigged”) to overcome the inherent consumption of oxygen by the sensor. The rate of jigging depends on the type of membrane on the sensor:

- 3” per second for 2.0 PE membrane
- 6” per second for 1.25 PE membrane
- 12” per second for Teflon membrane

#### 4. Responsibilities.

##### A. *Volunteer Monitors & Volunteer Groups*

- **Certification.** It is the responsibility of the individual obtaining this data to maintain current certification for the parameter(s) they collect if they wish their data to be



entered into the VRMP database. Training will be provided to volunteers on an annual basis by VRMP/DEP staff, and certification will last for one year from the date of training.

- **Data Recording.** It is the responsibility of the individual obtaining this data to record the results and additional qualifying information on current field sheets obtained from their affiliated watershed association or through the VRMP program of the DEP.
- **Data Quality Checks and Data Submission.** The data manager for the volunteer group will collect and enter volunteer field sheet data onto the appropriate computer file, perform quality assurance checks (Refer to Section 5.10 of the Quality Assurance Program Plan), and submit data to the VRMP following protocols outlined in the volunteer group’s latest sampling and analysis plan (SAP) that has been approved by the VRMP.

#### ***B. Volunteer River Monitoring Program (VRMP) Staff***

- **Oversight of Volunteer Groups and Volunteers.** VRMP staff will oversee volunteer groups and volunteers through a variety of ways including maintaining an up-to-date VRMP quality assurance program plan (QAPP); reviewing sampling and analysis plans (SAPs) of the volunteer groups; providing annual training/certification sessions for volunteers; conducting quality assurance checks on data submitted by volunteer groups and laboratories; and uploading data into the DEP’s EGAD database. These tasks are described in greater detail in the VRMP’s latest QAPP.

### **5. Guidelines and procedures.**

#### ***A. YSI Professional Plus Meter Preparation.***

- **Sensor options.** The Professional Plus has two sensor options for dissolved oxygen – Polarographic or Galvanic sensor. Be sure of which type of sensor is installed and follow requirements for that type of sensor and setup.
- **First time use.** Follow manufacturer’s instructions for preparation and set up of the meter for first time use. (Refer to Appendix A: “Setup”, pg. 2; “Preparing the DO Sensor for the First Time, pg. 21; and “Setup – Dissolved Oxygen, pg. 22).
- **Beginning of field season.** Before each field season, volunteer monitoring groups shall conduct a full inspection of the meter. If membrane has been stored dry, follow manufacturer’s instructions for first time use (see above). A new membrane and batteries shall be installed prior to the start of field sampling and additionally, as needed (refer to Appendix A, “Sensor Maintenance – Dissolved Oxygen”, pg. 60). In addition, each meter “setup” should be equipped with the following items so that field repairs can be undertaken as necessary:



- Extra O<sub>2</sub> solution and membrane caps for probe
  - Extra batteries
  - Field data sheet
  - Screwdriver for removing back of meter to replace batteries
  - Pencil with eraser
- **Prior to field sampling.** Before each field sample collection, the volunteer shall inspect the meter including an inspection of the condition of the probe membrane, membrane, and batteries.
    - (1) Check the membrane for air bubbles and wrinkles. If bubbles or wrinkles are present, remove membrane, refill with O<sub>2</sub> solution, and replace membrane (Refer to Appendix A, “Sensor Maintenance – Dissolved Oxygen”, pg. 60).
    - (2) Check to make sure drops of water are not clinging to the membrane. If drops are present, blow on membrane to gently remove droplets. Don't tap; these probes are very fragile. Replace probe into the calibration chamber on the side of the meter.
    - (3) Batteries should be checked for charge and/or expiration.
    - (4) Be familiar with the testing, inspection, maintenance, and calibration considerations described in sections 5.6 through 5.8 of the VRMP QAPP (MDEP, 2009).
    - (5) Power on the meter and allow sufficient warm-up time prior to initial use for the day. The Polarographic sensor requires 5-15 minutes to warm-up. The Galvanic sensor does not require a warm-up.
  - **Dissolved Oxygen Calibration.** If collecting dissolved oxygen measurements, the YSI Professional Plus meter shall be calibrated each time the unit is turned on. Meters shall be calibrated to a 100% water-saturated air environment (for instructions, refer to Appendix A, “Calibration – Dissolved Oxygen”, pg. 27).
  - **Dissolved Oxygen Check Against “Zero Dissolved Oxygen” Standard.** VRMP staff shall check DO meter using zero oxygen solution at the beginning of the field season. Volunteers shall check their DO meter using zero oxygen solution in mid-season and at the end of the field season. The zero oxygen solution is provided by VRMP/DEP staff. Volunteers shall record the dissolved oxygen value they measure with their meter in the appropriate blank on the field data sheet.

### ***B. Dissolved Oxygen and Temperature Measurements.***

- **Sampling Period and Site Location.** Sampling period and site location information will be documented in the volunteer groups' SAPs (that require approval by the VRMP) which are submitted by the volunteer groups prior to any sampling. (Detailed information regarding how volunteer groups are to obtain and document site location information can be found in VRMP SOP-02 [Documenting Site Location].)



- **Sample Timing.** Dissolved oxygen data collected between dawn and 8 am are important for assessment of attainment of DO criteria within Maine’s Water Quality Standards. But, except as naturally occurs, DO concentrations below the applicable DO criteria at any time of day signal non-attainment. If there are no DO concentrations below the criteria after 8 am, then data between dawn and 8 am must be collected to assess attainment of the criteria.
- **Familiarize Yourself With the Meter.** Familiarize yourself with the basic operation, keypad, and readouts of the meter (Appendix A, “Key Pad”, pg. 9 and “Main Display”, pg. 11).
- **General Sampling Protocol.**
  - Record site location on data sheet.
  - Remove probe from calibration cup or sleeve.
  - Submerge probe in the water at the site where you are monitoring, as described in your group’s approved SAP. Give the probe a quick shake to release any air bubbles.
  - For either parameter (DO or temperature), allow the temperature reading to stabilize (at least 15 seconds) before recording the value on the field sheet.
  - Follow the instructions below measuring specific parameters.
  - The meter should remain turned on between stations, unless time between samplings exceeds 30-60 minutes. If meter is turned off, the field probe should be stored inside the calibration chamber during transport, sufficient time (5-15 min) should be allowed for warm-up, and the meter should be re-calibrated.
- **Dissolved Oxygen Measurements.**
  - (1) Review and follow the instructions for making DO measurements in Appendix A, “Taking Measurements”, pg. 51. Record DO in both mg/L (or ppm) and % saturation.
  - (2) *Note of caution:* Unless the probe is equipped with a stirrer, jiggling of the probe is extremely important for obtaining accurate dissolved oxygen readings, unless you have placed the probe in a swiftly-moving section of stream or river. (The probe is dependent on the amount of oxygen that passes across the membrane, and the probe actually consumes oxygen as it is making measurements.)
- **Temperature Measurements.**
  - (1) Record temperature value displayed on the screen.
- **Quality Control.**
  - (1) At the beginning of each field season, all VRMP staff and VRMP volunteers who collect dissolved oxygen, temperature, specific conductance, and salinity data will have a training/refreshers/certification session to (re)familiarize themselves with the contents of this SOP.



(2) For every volunteer, a field duplicate shall be obtained for all parameters for at least 10% of their own sampling efforts. A field duplicate will be collected for every 10 samples monitored.

(3) Refer to the VRMP quality assurance project plan (QAPP) for more QA/QC details.

(4) Review “Preparing the DO Sensor for the First Time”, p. 21, “Set-up – Dissolved Oxygen”, p. 22 and “Sensor Maintenance – Dissolved Oxygen”, p. 60.

## 6. Equipment Care.

### A. *Start of field season.*

1. Follow manufacturer's directions for preparation of a new probe or renewing probe in the spring. Be sure to replace membrane at the start of each sampling season.
2. Use new batteries at start of each sampling season. An extra set of appropriate size batteries should be included in the meter carrying case.
3. Each D.O. meter should be equipped with extra items for making repairs in the field. See section 5-A of this SOP for a list of items.

### B. *Field Season*

1. Ideally the meter should be in water-resistant case with padding to protect it from damage.
2. Store the sensor in the sensor storage cup or sleeve. Keep the sponge moistened with tap water to maintain a 100% saturated air environment.
3. Allow the case and contents to air-dry at end of each day. This may be accomplished by simply propping the lid open. When contents are very wet, remove the contents and spread out to facilitate drying.
4. Keep meter from freezing.
5. Refer to Appendix A, “Sensor Maintenance – Dissolved Oxygen”, p. 60 and Appendix B, “YSI Calibration Tips” for manufacturer’s recommendations for maintenance requirements.

### C. *End of field season*

1. Completely dry meter, case, and all items in the case before storing.
2. Remove batteries.
3. Remove membrane.
4. Rinse entire probe and calibration chamber with distilled water and allow to air dry.
5. Install a clean dry new membrane cap over top of probe to keep dust and dirt out for winter.
6. Keep meter dry and at room temperature to prevent corrosion of electronic parts.
7. Review Appendix A for more tips.
8. Record winterization date and equipment repairs in your volunteer group’s Equipment Log.



9. Label the meter and case as ‘WINTERIZED’ in an obvious manner (so users will know the current status of the unit).

## 7. Specifications

Measurement	Range	Resolution	Accuracy
Temperature	-5 °C to 70 °C	0.1 °C	±0.2 °C
Dissolved Oxygen (%)	0 to 200%	0.1% or 1% user selectable	±2% air sat or ±2% of reading, whichever is greater
	200 to 500%		±6% of reading
Dissolved Oxygen (mg/L)	0 to 20 mg/L	0.01 mg/L or 0.1 mg/L, user selectable	±0.2 mg/L or ±2% or reading, whichever is greater
	20 to 50 mg/L		±6% of reading

## 8. Appendix

### A. YSI Meter owner’s manual:

YSI Incorporated. March 2009. YSI Model Professional Plus User Manual. Yellow Springs, Ohio.

### B. YSI Professional Plus Calibration Tips.

Rev A December 2010.

## 9. References

### A. DEP Standard Operating Procedures:

- Document number #:DEP-LW0890: Dissolved Oxygen and Temperature, Instantaneous Measurement using Electronic Meters
- Document number #: DEPLW0636: Protocols for using Hanna Dissolved Oxygen and Specific Conductance/Temperature/pH Meters

### B. Maine VRMP QAPP:

- Maine Department of Environmental Protection (MDEP). 2020. Maine Volunteer River Monitoring Program (VRMP) Quality Assurance Program Plan (VRMP). DEPLW-0984.



# Professional *Plus*



## USER MANUAL

# CONTENTS

---

Warranty .....	i
Introduction .....	1
Getting Started .....	1
Initial Inspection .....	1
Battery Installation .....	1
Setup .....	2
Keypad .....	9
Main Display .....	11
Menu Layout.....	11
Alpha/Numeric Entry.....	12
System Menu .....	13
Date/Time .....	13
GLP.....	14
Language .....	18
Radix Point .....	18
Logging .....	18
Auto Shutoff .....	19
Backlight .....	19
SW Version (Software Version).....	19
Serial #.....	19
Unit ID .....	20
Parameters: Setup, Display, Auto Stable, and Calibration .....	20
Temperature.....	20

Item # 605596  
Rev D  
Drawing # A605596  
March 2009

©2009 YSI Incorporated.

The YSI logo and Confidence Solution are registered trademarks of YSI Incorporated.

Teflon is a registered trademark of E. I. du Pont de Nemours and Company.

Microsoft and Windows are registered trademarks of the Microsoft Corporation in the United States and other countries.

Pentium is a registered trademark of Intel Corporation.



Dissolved Oxygen (DO) .....	21	Sensor Maintenance.....	60
Barometer .....	31	Sensor Storage .....	66
Conductivity.....	32	Troubleshooting .....	68
pH.....	38	Help .....	68
ORP .....	42	Error Messages .....	69
Ammonium, Nitrate, Chloride.....	45	Dissolved Oxygen .....	70
Taking Measurements.....	51	Restore Default Calibration Values .....	70
Dissolved Oxygen .....	51	Accessories / Part Numbers .....	71
Conductivity .....	52	Declaration of Conformity.....	75
pH/ORP .....	52	Recycling.....	78
Ammonium, Nitrate, and Chloride .....	52	Contact Information.....	79
Logging Data .....	52	Ordering and Technical Support.....	79
Files and Site Lists .....	53	Service Information .....	79
File Memory .....	53		
Viewing Saved Data .....	53		
Site List.....	54		
Folder .....	54		
Delete Data .....	54		
Data Manager Desktop Software.....	55		
Using the Communications Saddle.....	56		
Manage Logged Data .....	57		
Real Time Studies .....	57		
Configure Instruments.....	58		
Care, Maintenance, and Storage .....	58		
Updating Instrument Firmware .....	58		
General Maintenance .....	58		

---

THIS PAGE LEFT INTENTIONALLY BLANK

---

## WARRANTY

---

The YSI Professional Plus Instrument (Pro Plus) is warranted for three (3) years from date of purchase by the end user against defects in materials and workmanship, exclusive of batteries and any damage caused by defective batteries. Pro Plus field cables are warranted for two (2) years from date of purchase by the end user against defects in material and workmanship (6 months for non-field rugged cables\*). Pro Plus sensors (pH, ORP, pH/ORP combo, Polarographic DO) are warranted for one (1) year from date of purchase by the end user against defects in material and workmanship (6 months for ammonium\*\*, nitrate\*\*, chloride\*\*, and Galvanic DO). Pro Plus systems (instrument, cables & sensors) are warranted for 90 days from date of purchase by the end user against defects in material and workmanship when purchased by rental agencies for rental purposes. Within the warranty period, YSI will repair or replace, at its sole discretion, free of charge, any product that YSI determines to be covered by this warranty.

To exercise this warranty, call your local YSI representative, or contact YSI Customer Service in Yellow Springs, Ohio at +1 937 767-7241, 800-897-4151 or visit [www.YSI.com](http://www.YSI.com) (Support tab) for a Product Return Form. Send the product and proof of purchase, transportation prepaid, to the Authorized Service Center selected by YSI. Repair or replacement will be made and the product returned, transportation prepaid. Repaired or replaced products are warranted for the balance of the original warranty period, or at least 90 days from date of repair or replacement.

### LIMITATION OF WARRANTY

This Warranty does not apply to any YSI product damage or failure caused by:

1. failure to install, operate or use the product in accordance with YSI's written instructions;
2. abuse or misuse of the product;
3. failure to maintain the product in accordance with YSI's written instructions or standard industry procedure;
4. any improper repairs to the product;
5. use by you of defective or improper components or parts in servicing or repairing the product;
6. modification of the product in any way not expressly authorized by YSI.

THIS WARRANTY IS IN LIEU OF ALL OTHER WARRANTIES, EXPRESSED OR IMPLIED, INCLUDING ANY WARRANTY OF MERCHANTABILITY OR FITNESS FOR A PARTICULAR PURPOSE. YSI's LIABILITY UNDER THIS WARRANTY IS LIMITED TO REPAIR OR REPLACEMENT OF THE PRODUCT, AND THIS SHALL BE YOUR SOLE AND EXCLUSIVE REMEDY FOR ANY DEFECTIVE PRODUCT COVERED BY THIS WARRANTY. IN NO EVENT SHALL YSI BE LIABLE FOR ANY SPECIAL, INDIRECT, INCIDENTAL OR CONSEQUENTIAL DAMAGES RESULTING FROM ANY DEFECTIVE PRODUCT COVERED BY THIS WARRANTY.

\* The warranty period for the non-field rugged cables (605107, 605177, 605108, 605178, 605109, 605179) is listed as 6 months. However, the true “working life” of these sensors may be 3-9 months depending on storage and usage in solutions other than clean aqueous samples.

\*\* The warranty for the ammonium, nitrate, and chloride sensors (605104, 605105, 605106) is listed as 6 months. However, the true “working life” of these sensors may be 3-9 months depending on storage and usage in solutions other than clean aqueous samples.

## INTRODUCTION

---

Thank you for purchasing the YSI Professional Plus (Pro Plus). The Pro Plus features a waterproof (IP-67) case, backlit display and keypad, user-selectable cable options, USB connectivity, large memory with extensive site list capabilities, and a rugged, rubber over-molded case.

Reading the entire manual before use is recommended for an overall understanding of the instrument's features.

## GETTING STARTED

---

### INITIAL INSPECTION

---

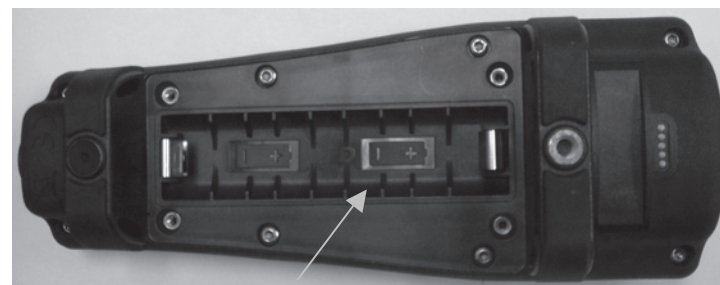
Carefully unpack the instrument and accessories and inspect for damage. Compare received parts with items on the packing list. If any parts or materials are damaged, contact YSI Customer Service at 800-897-4151 (+1 937 767-7241) or the authorized YSI distributor from whom the instrument was purchased.

### BATTERY INSTALLATION

---

The Pro Plus requires (2) alkaline C-cell batteries which are included with the purchase of a new instrument. Battery life depends on parameters and usage. Under normal conditions, battery life is approximately 80 hours for continuous use at room temperature. To install or replace the batteries:

1. Turn the instrument over to view the battery cover on the back.
2. Unscrew the four captive battery cover screws.
3. Remove the battery cover and install the new batteries, ensuring correct polarity alignment on the instrument or the removed cover. (Figure 1)
4. Replace the battery cover on the back of the instrument and tighten the four screws. Do NOT over-tighten.



*Figure 1. Pro Plus with battery cover removed. Notice battery symbols indicating polarities.*



Batteries must be installed in the instrument even if powering the unit via the USB connection. This will retain the correct date and time if the PC is turned off. If the USB power is disconnected and there are no batteries in the instrument, the date and time will need to be reset upon subsequent power on.

NOTE - On subsequent battery changes you will have approximately 2 minutes to change the batteries before the clock resets. If the clock resets, the instrument will automatically bring up the Date/Time menu the next time it is powered on in order to update this information. This is important, especially if you intend to log data!

## SETUP

The Pro Plus instrument has several compatible field-rugged cable/sensor options, each with temperature:

<u>Cable:</u>	<u>Available Sensors:</u>
Cable number 60520-x	DO/temp (605780 for lab BOD)
Cable number 60530-x	Conductivity/temp
Cable number 60510-x	ISE*/temp
Cable number 6051010-x	ISE*/ISE*/temp
Cable number 6051020-x	ISE*/DO/temp
Cable number 6051030-x	ISE*/conductivity/temp
Cable number 6052030-x	DO/conductivity/temp
Cable number 605790-x	DO/conductivity/ISE*/ISE*/temp (Quatro**)

\*ISE (Ion Selective Electrode) notates a port that can accept pH, ORP, Ammonium, Nitrate, Chloride, and, in some cases, a pH/ORP combination sensor.

\*\*Cable 605790 will be referred to as a Quatro cable throughout this manual.

All cables come in standard lengths of 1, 4, 10, 20, and 30-meters (3.28, 13, 32.8, 65.6, and 98.4-feet) with options for special order lengths up to 100-meters (328-feet) on the 60520-x cables. Contact YSI or your local representative for additional information.

In addition there are several cable options with built in sensors for the measurement of pH and ORP that are not considered field-rugged (non-replaceable sensors, less rugged single-junction sensors). These cables are

recommended for lab use or controlled conditions where a more rugged, field cable is not necessary. These cables include:

Cable number 605107	1-meter cable; single-junction pH sensor
Cable number 605177	4-meter cable; single-junction pH sensor
Cable number 605108	1-meter cable; single-junction ORP sensor
Cable number 605178	4-meter cable; single-junction ORP sensor
Cable number 605109	1-meter cable; single-junction pH/ORP sensors
Cable number 605179	4-meter cable; single-junction pH/ORP sensors

## STANDARD PRO SERIES SENSOR INSTALLATION

Throughout the manual, the term “sensor” refers to the removable portion or electrode sensing portion of the cable assembly. For example, the DO sensor or pH sensor is the part that can be removed from a field cable and replaced with a new sensor. The conductivity sensor is not removable from a non-Quatro cable but still refers to the “sensing” portion and will be referred to as a sensor. This section covers most of the sensor installations on a Professional Series cable bulkhead including the following sensors:

2003 - Polarographic DO (black)	1001 - pH	1003 - pH/ORP	1005 - Chloride
2002 - Galvanic DO (gray)	1002 - ORP	1004 - Ammonium	1006 - Nitrate

See the next section of this manual for installation instructions for the Quatro cable’s Conductivity/Temperature sensor.



Dual sensor bulkhead ports are numbered 1 and 2, see figure to the left. Please refer to the following tables to determine correct sensor installation into each port of a two port cable.

	<b>Port 1 Options</b>	<b>Port 2 Options</b>
1010 dual cable	pH	pH
	ORP	ORP
	pH or pH/ORP*	pH or pH/ORP*
	ammonium	ammonium
	chloride	chloride
	nitrate	nitrate
		none (port plug)

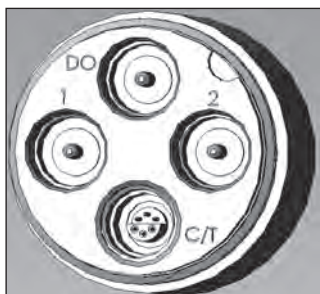
\* If using a 6051010 cable, a sensor must be installed in port 1 for correct operation. If you install a pH/ORP combo sensor into a 6051010 cable, ORP will not be measured. It is not recommended to use a pH/ORP combo sensor on a 6051010 cable.

	<b>Port 1 Options</b>	<b>Port 2 Options</b>
1020 dual cable	pH	Polarographic DO
	ORP	Galvanic DO
	pH or pH/ORP	none (port plug)
	ammonium	
	chloride	
	nitrate	
	none (port plug)	

If using a 1020 cable, install a pH, ORP, pH/ORP, Ammonium, Nitrate or Chloride sensor in port 1 and a DO sensor in port 2.



*If using a 605103 pH/ORP combination probe on a 6051020 or 6051030 cable you can report both pH and ORP. However, it is recommended to set ISE1 as pH and ISE2 as ORP in the Sensor Setup menu.*



The Quatro cable bulkheads are labeled 1, 2, DO, and CT, see figure to the left. All sensors except the Conductivity/Temperature sensor can be installed following the Standard Pro Series Sensor Installation instructions. Conductivity/Temperature sensor installation is described in the next section. For ease of installation, YSI recommends that you install a sensor into port 1 first; followed by DO installation, then port 2, and lastly C/T.

	<b>Port 1 Options</b>	<b>Port 2 Options</b>	<b>DO Port Options</b>	<b>CT Port Options</b>
Quatro Cable (pn: 605790)	pH	pH	Polarographic DO	5560 Conductivity/ Temperature sensor only
	ORP	ORP	Galvanic DO	
	pH or pH/ORP*	pH or pH/ORP*	none (port plug)	
	ammonium	ammonium		
	chloride	chloride		
	nitrate	nitrate		
		none (port plug)		

\* If using a Quatro cable, a sensor must be installed in port 1 for correct operation of port 2. If you install a pH/ORP combo sensor into a Quatro cable, ORP will not be measured. It is not recommended to use a pH/ORP combo sensor on a Quatro cable.



*Before installing either dissolved oxygen sensor, the instrument must be configured for the sensor being installed. See the Setup - Dissolved Oxygen section of this manual for instrument configuration instructions. Failure to do this may result in damage not covered under warranty.*

**First, ensure both the sensor connector and sensor port on the cable are clean and dry.** To connect the sensor, grasp the sensor with one hand and the sensor connection end of the cable (bulkhead) in the other. Push the sensor into the connector on the cable until it is properly seated and only one o-ring is visible. Failure to properly seat the probe may result in damage. Twist the sensor clockwise to engage threads and finger tighten (Figure 2). Do not use a tool. This connection is waterproof. Please refer to the sensor installation sheet that is included with each sensor for detailed instructions.

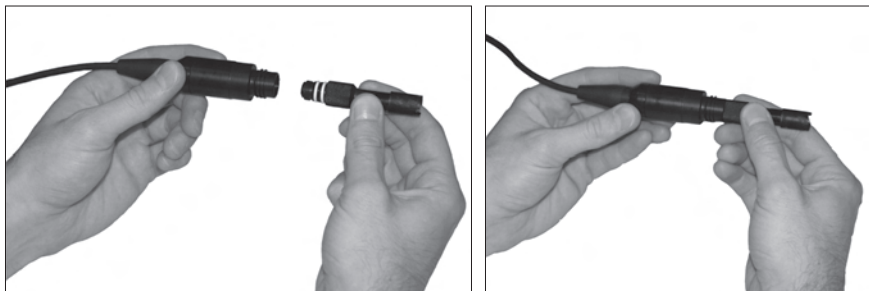


Figure 2. The image on the left shows a clean, dry sensor being aligned with the bulkhead. On the right, the sensor has been pushed into the bulkhead and is being screwed into place.

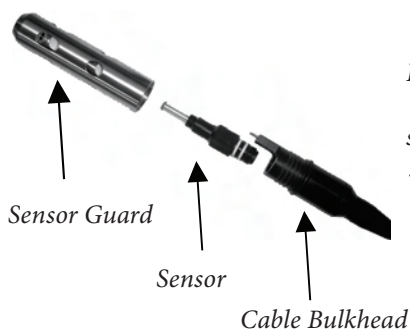


Figure 3. The sensor(s) will install directly in the cable bulkhead. Once installed, the sensor guard will protect the sensor during sampling (DO cap membrane not shown).

## CONDUCTIVITY/TEMPERATURE SENSOR INSTALLATION IN A QUATRO CABLE

As mentioned, the installation of the Conductivity/Temperature sensor (model 5560) in a Quatro cable is different from all other Pro Series sensor installations. Follow these instructions when installing a conductivity/temperature sensor in a Quatro cable:

1. Locate the C/T port and, if replacing, remove the old sensor using the installation tool to loosen the stainless steel retaining nut. Once the stainless steel retaining nut has been completely unscrewed from the bulkhead, remove the old sensor from the bulkhead by pulling the sensor straight out of the bulkhead.
2. Apply a thin coat of o-ring lubricant (supplied with the sensor) to the o-rings on the connector side of the new sensor.

**i** Visually inspect the port for moisture. If moisture is found, it must be completely dried prior to sensor installation.

3. Align the connectors of the new sensor and the port. With connectors aligned, push the sensor in towards the bulkhead until you feel the sensor seat in its port. You will experience some resistance as you push the sensor inward, this is normal
4. Once you feel the sensor seat into the port, gently rotate the stainless steel sensor nut clockwise with your fingers, Do not use the tool.
5. The nut must be screwed in by hand. If the nut is difficult to turn, STOP, as this may indicate cross threading. If you feel resistance or cross threading at any point, unscrew the nut and try again until you are able to screw the nut down completely without feeling any resistance. Damage to your cable/sensor may occur if you force the parts together.
6. Once completely installed, the nut will seat flat against the bulkhead. At this point, use the tool that was included with the sensor to turn the nut an additional  $\frac{1}{4}$  to  $\frac{1}{2}$  turn so it cannot come loose (figure 4). DO NOT over tighten.

**i** Do not cross thread the sensor nut. Seat nut on face of bulkhead. Do not over tighten.

Please refer to the sensor installation sheet that is included with the conductivity/temperature sensor for detailed instructions.

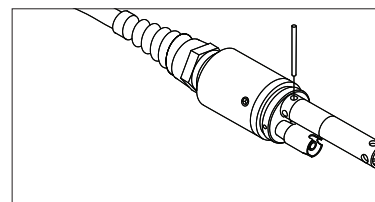


Figure 4. Installation tool used to tighten stainless steel retaining nut of 5560 conductivity/temperature sensor.

## INSTALLING PORT PLUGS IN UNUSED PORTS

As necessary, install a port plug into any port that does not have an installed sensor. This will protect the bulkhead from water damage. Port plugs and a tube of o-ring lubricant are included with all Quatro cables. These items can be ordered separately if needed. To install a port plug, apply a thin coat of o-ring lubricant to the two o-rings on the port plug. After application, there should be a thin coat of o-ring lubricant on the o-rings. Remove any excess o-ring lubricant from the o-ring and/or port plug with a lens cleaning tissue. Next, insert the plug into an empty port on the bulkhead and press firmly until seated. Then, turn the plug clockwise to engage the threads and finger-tighten until the plug is installed completely. Do **not** use a tool to tighten the plug.

## CONNECTING THE CABLE TO AN INSTRUMENT

To connect a cable, align the keys on the cable connector to the slots on the instrument connector. Push together firmly, then twist the outer ring until it locks into place (figure 5). This connection is water-proof.



Figure 5. Note the keyed connector. The cable and instrument connectors can only be mated once the keys are properly aligned.



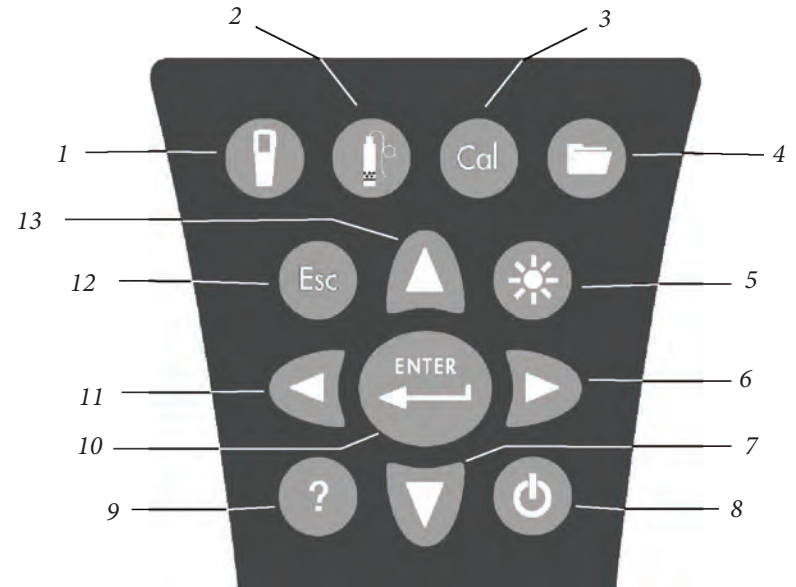
When a sensor is not installed, the sensor and cable sensor connectors are NOT water-proof. Do not submerge the cable without a sensor or port plug installed in all available ports.

When the cable is disconnected, the cable's instrument connector and the connector on the instrument maintain an IP-67 rating.









## SENSOR STORAGE

The cable assembly is supplied with a storage container, or sleeve, that installs on to the cable. The container is used for short-term storage (less than 30 days). Be sure to keep a small amount of moisture (tap water) in the container during storage. This is done to maintain a 100% saturated air environment which is ideal for short-term sensor storage (see Care, Maintenance, and Storage for more detailed information). Do not submerge the sensors in an aqueous solution. The intent is to create a humid air storage environment.


## KEYPAD

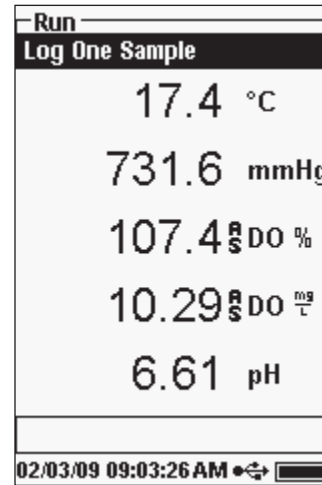


Number	Key	Description
1		<b>System</b> Opens System Menu from any screen. Use to adjust system settings.
2		<b>Sensor</b> Opens Sensor Menu from any screen. Use to enable sensors and display units.
3		<b>Calibrate</b> Opens Calibrate Menu from any screen. Use to calibrate all parameters except temperature.
4		<b>File</b> Opens File Menu from any screen. Use to view data and GLP files, set up site and folder lists, and delete data.
5		<b>Backlight</b> Press to turn the instrument backlight on and off and to adjust the display contrast when pressed with the left or right arrow key.

Number	Key	Description
6		<b>Right Arrow</b> Use to navigate right in alpha/numeric entry screens. Can be pressed simultaneously with Backlight key to increase display contrast.
7		<b>Down Arrow</b> Use to navigate through menus and to navigate down in alpha/numeric entry screens.
8		<b>Power</b> Press to turn the instrument on. Press and hold for 3 seconds to turn off.
9		<b>Help</b> Press to receive hints & tips during operation.
10		<b>Enter</b> Press to confirm selections, including alpha/numeric key selections.
11		<b>Left Arrow</b> Use to navigate left in alpha/numeric entry screens. Press to return to previous menu in all screens except alpha/numeric entry. Can be pressed simultaneously with Backlight key to decrease display contrast.
12		<b>Exit/Escape</b> Exits back to Run Screen. When in alpha/numeric entry screen, escapes to previous menu.
13		<b>Up Arrow</b> Use to navigate through menus and to navigate up in alpha/numeric entry screens.


## MAIN DISPLAY

Press the Power key  to turn the instrument on. The instrument will briefly display the splash screen with the YSI logo then go directly to the main run screen. The first time the instrument is powered up or if the instrument has had a battery change (with batteries removed for more than 2 minutes), you will need to set the date and time. Follow the instructions under **System Menu | Date/Time**.



The display at the left shows the run mode (main display) with temperature in °C, barometer in mmHg, DO in % and mg/L, and pH as the reported parameters. The date, time and battery level are indicated at the bottom of the screen. The logging preference of Log One Sample at a time is indicated at the top of the screen.







This screen also shows the message line towards the bottom of the display above the date and time. In this case, it doesn't show a message but messages will appear frequently to indicate calibration steps, set date and time, etc.

A USB symbol  will show up on the bottom of the display when connected to a PC through USB with the communications saddle. The instrument will display full battery power when it is receiving power through the USB connection.



**Contrast** – the contrast adjustment can be accomplished by pressing the backlight key and the left or right arrow key at the same time.

## MENU LAYOUT

Press Esc  at anytime in the menus to escape back to the Run screen. The left arrow  can be used to go back to the previous menu in all screens except alpha/numeric entry screens. You must use Esc to get out of the alpha/numeric screens if you want to exit before finishing or without saving changes. Functions that are enabled appear as a circle with a dot  or a box with a check mark . Disabled functions appear as a circle only  or an empty .



## ALPHA/NUMERIC ENTRY

The numeric screens will display numbers only (shown on the left). Alpha/numeric screens will display numbers across the top and letters along the bottom rows (shown on the right). Letters appear as a common keyboard arrangement.

When an alpha or numeric character is required, the screen will show the alpha/numeric entry screen. To select a character, highlight it by using the arrow keys to move the highlight box over the desired selection. Then, press **Enter** on the keypad to confirm the selection. After confirming the selection, it will appear in the line at the top of the display.

For capital letters or lower case entry, highlight “SHIFT” and press **Enter** on the keypad to change the characters from upper to lower case.

To delete the entire line of the current entry, highlight **←** and press **Enter** on the keypad. The **←** symbol functions as a backspace key in the alpha/numeric entry screens by deleting one character at a time. Use the “SPACE” function to add a space between characters.

When you have finished entering the correct information (16 character max), highlight <<<ENTER>>> at the bottom of the screen and press **Enter** on the keypad to confirm.



The **←** key cannot be used to escape to the previous menu from an alpha/numeric entry screen. Instead, use the **Esc** key to go back to the previous menu when in alpha/numeric entry screens.

## SYSTEM MENU

Press System **ⓘ** to access any of the following menu items.

The System menu will allow you to access the setup options of the instrument including; **Date/Time**, **GLP**, **Language**, **Radix Point**, **Logging**, **Auto-Shutoff**, **Backlight**, **SW** (Software) **Version**, **Serial #**, and **Unit ID**. Any item with [brackets] shows the current setting inside the brackets. For instance, in the example at the left, Radix Point is currently set to [Decimal]. The brackets will also give a quick visual clue as to what items can be changed.

## DATE/TIME

Highlight **Date/Time** from the **System** menu. Press enter to select.

**Date Format** – Highlight and press enter to open a sub menu for selecting the preferred date format: YY/MM/DD, MM/DD/YY, DD/MM/YY, or YY/DD/MM.

**Date** – Highlight and press enter to use the numeric entry screen to set the correct date.

**Time Format** – Highlight and press enter to open a submenu to select the preferred time format from 12-hour or 24-hour.

**Time** – Highlight and press enter to use the numeric entry screen to set the correct time.



The date and time will need to be reset if a battery change takes longer than 2 minutes. When this occurs, the Date/Time menu will automatically appear upon power up and require you to set the date and time.

## GLP

The GLP or 'Good Laboratory Practice' file saves detailed information about calibrations. It also includes diagnostic information about the sensors. Calibrations are logged into a file, the GLP, for later review as needed. A single GLP file is utilized to store all calibration records and is capable of storing 500 records. Once the GLP file is full, the instrument will begin to overwrite the oldest record with each new calibration record.



*In order to keep all of your GLP records, periodically download the GLP to Data Manager and export it to another program. Otherwise, the unit will overwrite the oldest record once the memory is full. Also, since Data Manager saves GLP files under the Unit ID, you must periodically export and rename the GLP file on your PC or it will be overwritten each time you upload the GLP file from the instrument.*

Several calibration parameters are saved for each calibration record including optional ones that can be enabled by the user. Standard parameters include date/time stamp, calibration method, and sensor information. Optional, user selectable parameters include User ID, Probe ID, and User Fields 1 and 2.

The sensor specific information that is saved with each calibration point is different for each sensor. The sensor specific values saved are:

### Conductivity

Method (Spec Cond, Cond, Salinity)  
Cal Value (value of calibration solution)  
Sensor Value (Cell Constant)  
Temperature Reference (User selected in Sensor Setup menu)  
Temperature Compensation Coefficient %/°C (User selected in Sensor Setup menu)  
TDS Constant (User selected in Sensor Setup menu)  
Temperature  
Cal Cell Constant  
Calibrate Status

### DO

Method (% , mg/L)  
Cal Value  
Sensor Value (Sensor Current)  
Sensor Type (Polarographic/Galvanic)  
Membrane Type (Teflon Black, PE Yellow, PE Blue)  
Salinity Mode (user entered value if in Manual Salinity Mode)  
Temperature  
Barometer  
Calibrate Status

### pH (up to 6 calibration points)

Buffer Value  
Sensor Value (mV)  
Temperature  
Slope (mV/pH)  
Slope (% of ideal)  
Calibrate Status

### ORP

Cal Solution Value  
Sensor Value  
Temperature  
Calibrate Status

### Ammonium

Buffer Value  
Sensor Value (mV)  
Temperature  
Calibrate Status

### Chloride

Buffer Value  
Sensor Value (mV)  
Temperature  
Calibrate Status

### Nitrate

Buffer Value  
Sensor Value (mV)  
Temperature  
Calibrate Status

**An example of a GLP record**

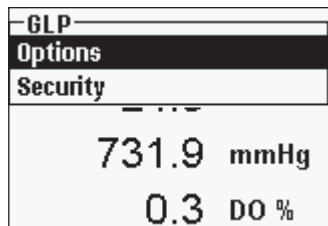
(Operation performed is single point % DO Calibration)

\*\*\* Calibrate – DO% \*\*\*

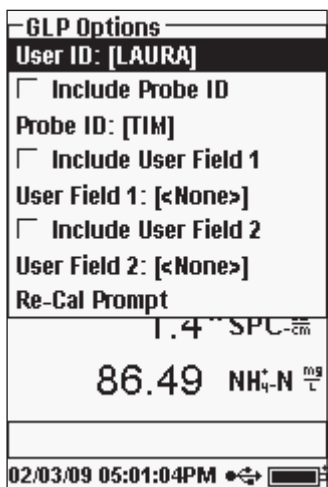
Date 02/03/09 MM/DD/YY  
 Time 12:14:57PM 12-hour  
 User ID: Tech 1  
 Probe ID 08D

Method DO Air Calibrate  
 Cal Value: 100.00%  
 Sensor Value: 5.175155uA  
 Sensor Type Polarographic  
 Membrane Type 1.25 PE Yellow  
 Salinity Mode 5.175165 Auto  
 Temperature 23.9 °C  
 Barometer 731.4 mmHg  
 Calibrate Status Calibrated

**GLP SETTINGS**



In the System menu, highlight **GLP** and press enter to view and modify the GLP settings.



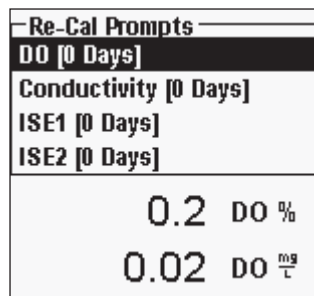
Highlight **Options** and press enter to access **User ID**, **Probe ID**, **User Defined Fields**, and **Re-Cal Prompt**.

**User ID** may be used to identify the person calibrating the instrument. Highlight **User ID** and press enter to select, edit, or delete a User ID from a list of previously entered IDs. Or, highlight **Add New** and press enter to create a new User ID using the alpha/numeric entry screen. The User ID may also be changed in the **Calibration** menu during the calibration process. The selected User ID will be stored in the GLP file with each calibration record. A User ID could be a person’s initials or badge number. The character limit is 16 characters.

**Probe ID** is stored with the calibration record and may be used to distinguish one cable/probe

assembly from another, typically by serial number. Highlight **Include Probe ID** and press enter to turn this function on (☑) and off (☐). Highlight **Probe ID** and press enter to add, view, edit, delete, or select a Probe ID. The Probe ID may also be changed in the **Calibration** menu during the calibration process. The character limit is 16 characters.

**User Fields 1 and 2** are stored with the calibration record and may be used to enter other parameters pertinent to the user, such as weather conditions, elevation, etc. Highlight **Include User Field 1** or **Include User Field 2** and press enter to turn this function on and off. Highlight **User Field 1** or **User Field 2** and press enter to add, delete, view, edit, or select a User Field. The character limit is 16 characters. When enabled, a prompt for selecting a User Defined Field will appear during the calibration process.



**Re-Cal Prompt** may be used to remind the user to perform a calibration. To set a time interval, highlight the parameter you wish to be reminded about and press enter to access the numeric entry screen. Enter a value in days and press enter to confirm the reminder time. To turn off the Re-cal prompt, set the reminder to zero (0) days (this is the default).

The **Security** section of the GLP menu is a password protected area. This area includes options to set a new password and to lock access to the calibration menu. When first viewing the security menu, you will be required to enter a password. Use the “shift” on the alpha/numeric screen to switch to lower case if necessary and enter “ysi123”. This is the default password.

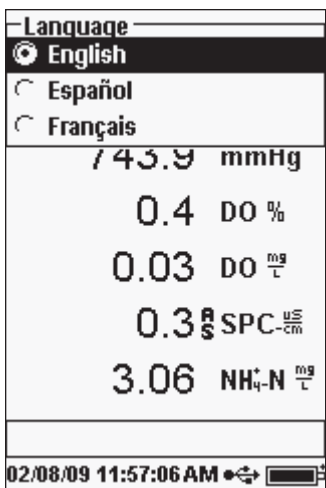
**Protect Cal** can be enabled (☑) or disabled (☐). When enabled, the user must know and enter the instrument’s password to enter the calibration menu option. Highlight **Protect Cal** and press enter to enable or disable this feature.

**Set Password** allows a user to set the security password. Highlight **Set Password**, press enter, and use the alpha/numeric entry screen to set the new password. The password can have up to 16 characters.


Contact YSI Technical Support at environmental@ysi.com or +1 937 767-7241 if you forget or misplace your password.

**i** Once a password is set, and the GLP security screen exited, a password must be entered to make changes under GLP security. Keep passwords in a safe place.

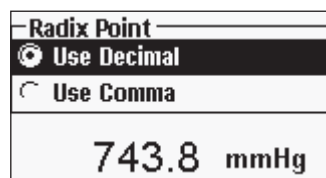
## LANGUAGE



The Pro Plus can be configured to display all text in English, Spanish, French, German, Portuguese, Italian, Norwegian, Simplified Chinese, Traditional Chinese, or Japanese. From the factory, the instrument includes English, Spanish, and French language options. The other language options can be downloaded from [www.ysi.com/support](http://www.ysi.com/support).

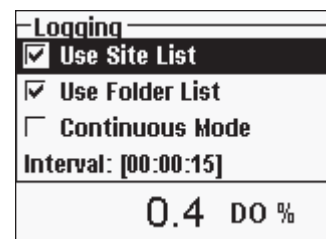
Once the appropriate language file is in the instrument, press System , highlight **Language**, and press enter. Highlight the desired language and press enter to confirm.

## RADIX POINT



**Radix Point** allows the user the option to choose between a comma or a decimal in numeric displays. For example, 1.00 becomes 1,00 when **Use Comma** is selected. Highlight **Use Decimal** or **Use Comma** and press enter to make your selection.

## LOGGING



From the System menu, highlight **Logging** and press enter to view or change the logging options. Logging options include **Use Site List**, **Use Folder List**, **Continuous Mode**, and **Interval**.

**Use Site List** and **Use Folder List** are optional ways of filing or 'tagging' your logged data points. If these settings are enabled, you will be

prompted to select a Site and/or Folder to 'tag' to the logged data point. See the **File and Site Lists** section of this manual for information on creating Site and Folder Lists.

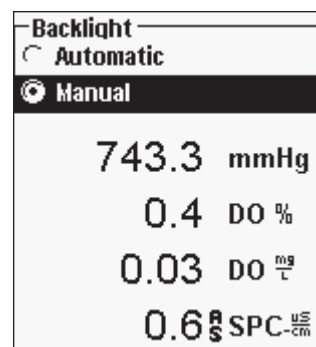
Check the box for **Continuous Mode** if you want to log samples continuously at a specific time interval. To set the length of time between logged samples, highlight **Interval** and press enter. Enter the interval as HH:MM:SS. This interval will display at the top of the screen when you select the **Start Logging** option in run mode.


To log one sample at a time, uncheck **Continuous Mode**. When Continuous Mode is unchecked, **Log One Sample** will appear at the top of the run screen.

## AUTO SHUTOFF

**Auto Shutoff** powers the instrument off after a user specified time period. Highlight **Auto Shutoff** and press enter. Using the alpha/numeric entry screen, enter a value between 0 and 360 minutes. To disable auto shutoff, set the value to 0 (zero).

## BACKLIGHT



**Backlight** can be set to **Automatic** or **Manual**. Automatic turns the backlight on when you turn the instrument on and when you press any key. Manual allows you to turn the backlight on or off with the backlight key . When in Automatic mode, the instrument will turn the backlight off 60 seconds after the last key press. The instrument will "reset" the 60 second time period every time a key is pressed. The lighted keypad will turn off after approximately 20 seconds.

## SW VERSION (SOFTWARE VERSION)

**SW Version** shows the instrument's software version. The instrument's software can be updated via [www.ysi.com/support](http://www.ysi.com/support). There you will find the new software files and instructions on how to update the instrument. There is no need to send the instrument back to the factory for upgrades.

## SERIAL #

**Serial #** shows the instrument's serial number and allows you to match it with the number engraved on the back of the instrument's case.

## UNIT ID

**Unit ID** is used to identify instruments in the Data Manager software program that was included with your instrument. It is also used to identify GLP files, Site Lists, Configuration files, and Data files transferred from the instrument to the PC. The default Unit ID is the instrument's serial number. To modify the Unit ID, highlight **Unit ID**, press enter and then use the alpha/numeric entry screen. The character limit is 16 characters.

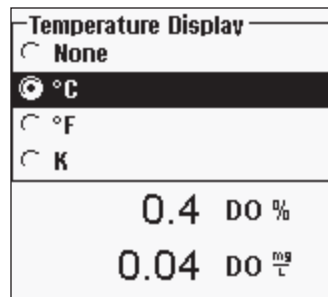
## PARAMETERS: SETUP, DISPLAY, AUTO STABLE, AND CALIBRATION

The following section is separated by parameter and will discuss sensor setup, display options, auto stable features, and calibration procedures for each parameter. The sections are separated by parameter due to the versatility of the Pro Plus. You may focus solely on the parameters of your choice.


For the highest accuracy, calibrate or verify each sensor regularly. For your convenience, YSI offers 5580 Confidence Solution® which allows you to check the accuracy of pH, conductivity, and ORP readings to help determine if a sensor calibration is necessary.

If you receive an error message during a calibration that indicates questionable results, you have the option to either accept or decline the calibration. YSI recommends that you decline a questionable calibration since accepting it may result in erroneous data. After declining a questionable calibration, ensure the sensor is clean, the calibration solution is good, the calibration vessel is clean, and that you are entering the correct calibration value if entering manually. Then, try to recalibrate the sensor. If you continue to have problems, see the Troubleshooting section of this manual.

## TEMPERATURE



All probe/cable assemblies, except the Quatro, have a built-in temperature sensor. The Quatro cable ships with a Conductivity/Temperature sensor that must be installed on the cable. Temperature calibration is not required nor is it available.

To set the units, press Sensor , highlight **Display** and press enter. Highlight **Temperature** and press enter. Highlight the desired

temperature units of °F, °C, or K and press enter to confirm the selection. Only one temperature unit may be displayed at a time. You may also choose not to display temperature. If you choose not to display temperature, other parameters that require a temperature reading will still be temperature compensated.

## DISSOLVED OXYGEN (DO)

DO sensors can be used on 60520-X, 6051020-X, 6052030-X, and Quatro cables.


### PREPARING THE DO SENSOR FOR THE FIRST TIME

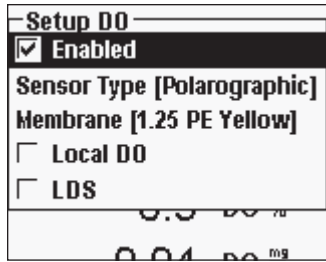
The dissolved oxygen sensor is shipped with a dry, protective red cap that will need to be removed before using. It is very important to put a new membrane with electrolyte solution on the sensor after removing the red cap.

Prepare the membrane solution according to the instructions on the bottle. After mixing, allow the solution to sit for 1 hour. This will help prevent air bubbles from later developing under the membrane. Ensure you are using the correct electrolyte solution for the correct sensor. Galvanic sensors utilize electrolyte with a light blue label and Polarographic sensors utilize electrolyte with a white label. The dissolved oxygen sensor is supplied with cap membranes specific to the sensor type ordered (Polarographic or Galvanic). 5912, 5913, and 5914 membrane kits are for Galvanic sensors and the 5906, 5908, and 5909 membrane kits are for Polarographic sensors. See the **Setup - Dissolved Oxygen** section of this manual for more information on the different types of membranes available from YSI.

Remove the red cap by pulling it straight off the sensor tip. Discard or save for later use during long term storage. Thoroughly rinse the sensor tip with distilled or deionized water. Fill the cap membrane 3/4 full of electrolyte solution, then tap the cap with a finger to release any trapped air. Be careful not to touch the membrane portion of the cap. Thread the membrane cap onto the sensor, moderately tight. Do not use a tool. It's typical for some of the electrolyte solution to spill over. For detailed instructions on changing a membrane cap, see the **Care, Maintenance, and Storage** section of this manual.

## SETUP - DISSOLVED OXYGEN

Press Sensor , highlight **Setup** and press enter. Next, highlight **DO** and press enter.



**Enabled** allows you to enable or disable the Dissolved Oxygen function. Highlight **Enabled** and press enter to activate() or deactivate() dissolved oxygen. Disable dissolved oxygen if you do not have a dissolved oxygen sensor connected to the instrument.



*If a sensor is Enabled that isn't connected to the instrument, the display will show an unstable, false reading, ?????, or ---- next to the units.*

**Sensor Type** sets the type of oxygen sensor being used: either Polarographic (black) or Galvanic (grey). Highlight **Sensor Type** and press enter. Highlight the correct sensor type installed on the cable and press enter to confirm.

If using a ProBOD sensor/cable assembly, the sensor type should be set to polarographic.

The Pro Plus has two compatible sensors for use with a field cable:

**Polarographic** – This sensor has a black sensor body and is engraved with the model number 2003.

**Galvanic** – This sensor has a grey sensor body and is engraved with the model number 2002.

In terms of physical configuration, membrane material, and general performance, YSI Professional Series Galvanic dissolved oxygen sensors are exactly like the Professional Series Polarographic sensors. The advantage of using Galvanic sensors is convenience. Galvanic sensors provide for an instant-on sensor without the need for warm-up time but this affects the life of the sensor. Polarographic sensors last longer and have a longer warranty but require a 5-15 minute warm-up time before use or calibration.



**IMPORTANT** – *The instrument default setting is Galvanic. Please change the **Sensor Type** to match the correct sensor. If you observe readings very close to 0 or extremely high readings (i.e. 600%), your **Sensor Type** setting (Polarographic or Galvanic) may be set incorrectly and you should immediately ensure it matches the sensor installed on your cable.*

**Membrane** sets the type of membrane used on the dissolved oxygen sensor. Highlight **Membrane** and press enter. Highlight the correct membrane type installed on the sensor and press enter to confirm. The DO sensor is supplied with membranes specific to the sensor type ordered and are color coded as described in the following tables.

Galvanic membrane kits:

Item	Color	Material	Description
5912	Black	1 mil Teflon®	Traditional membrane material
5913	Yellow	1.25 mil polyethylene	Improved response time and less flow dependence than Teflon® Ships standard with the sensor.
5914	Blue	2 mil polyethylene	Less flow dependence than 1.25 mil but somewhat slower response

Polarographic membrane kits:

Item	Color	Material	Description
5906	Black	1 mil Teflon®	Traditional membrane material
5908	Yellow	1.25 mil polyethylene	Improved response time and less flow dependence than Teflon® Ships standard with the sensor.
5909	Blue	2 mil polyethylene	Less flow dependence than 1.25 mil but somewhat slower response

Selecting a Dissolved Oxygen Membrane:

Membrane Type	Flow Dependence After 4 Minutes	Typical Response Time - 95%
5912, 5906 - Black	60%	18 seconds
5913, 5908 - Yellow	25%	8 seconds
5914, 5909 - Blue	18%	17 seconds


**Local DO** allows for localized DO% measurements. This sets the calibration value to 100% regardless of the altitude or barometric pressure. Highlight **Local DO** and press enter to enable () or disable () this function. Local DO is a method for the Pro Plus to factor in the barometric pressure on each DO measurement. In essence, if the barometric pressure changes you wouldn't notice the difference in the DO% readings in air-saturated water or water-saturated air. Local DO is ideal for EU compliance. When Local DO is enabled, an L will appear next to DO% on the run screen. DO mg/L readings are unaffected by the selection of DO Local.

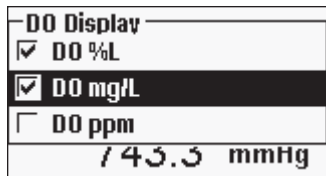
**LDS (Last Digit Suppression)** rounds the DO value to the nearest tenth; i.e. 8.27 mg/L becomes 8.3 mg/L. Highlight **LDS** and press enter to enable () or disable () this function.

---

#### DISPLAY - DISSOLVED OXYGEN

---

Press Sensor , highlight **Display** and press enter. Highlight **DO** and press enter. All DO units can be displayed simultaneously. Highlight the unit(s) and press enter to activate () or deactivate () units from the run screen. Note - You will not be able to display dissolved oxygen unless it is **Enabled** in the Sensor Setup menu first, see previous section.



**DO %** will show DO readings in a percent scale from 0 to 500%.

**DO mg/L** will show DO readings in milligrams per liter (equivalent to ppm) on a scale from 0 to 50 mg/L.

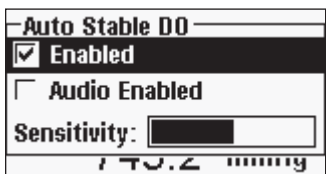
**DO ppm** will show DO readings in parts per million (equivalent to mg/L) on a scale from 0 to 50 ppm.


---

#### AUTO STABLE - DISSOLVED OXYGEN

---

**Auto Stable** indicates when a reading is stable. When Auto Stable is enabled, **AS** will blink next to the parameter until it is stable. Once the parameter is stable, **AS** will stop blinking.



To enable Auto Stable, press Sensor , highlight **Auto Stable** and press enter. Highlight **DO** and press enter.

Highlight **Enabled** and/or **Audio Enabled** (instrument will beep when the stability

is achieved) and press enter to confirm. The Auto Stable **Sensitivity** can be decreased or increased. Highlight **Sensitivity** and use the left and right arrow keys to slide the bar. The more sensitive you make it (larger black bar) the harder it is to achieve stability in a changing environment.

The **Auto Stable** system works by examining the previous 5 readings, computing the percent change in the data and comparing that change against a % threshold value. The % threshold value is determined by the **Sensitivity** bar setting. The following chart can be used as a guide when setting the Sensitivity bar.

<i>Sensitivity selected by User</i>	<i>% Data Variance Threshold</i>
100 - Most Sensitive, Sensitivity bar is set to the far right	0.05%
75	0.62525%
50	1.275%
25	1.8875%
0 - Least Sensitive, Sensitivity bar is set to the far left	2.5%

#### Example:

The instrument obtained the following data:

- Reading #1 95.5 DO%
- Reading #2 95.7 DO%
- Reading #3 95.8 DO%
- Reading #4 96.1 DO%
- Reading #5 95.3 DO%

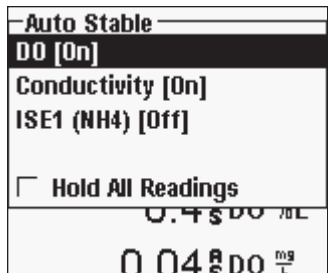
The instrument is programmed to determine the minimum and maximum data value over the previous 5 samples, and to compute the percent difference between those values. In this example, that gives a percent change of:

$$\% \text{ Change} = 100 * ((96.1 - 95.3) / 95.3)$$

$$\% \text{ Change} = 0.83\%$$

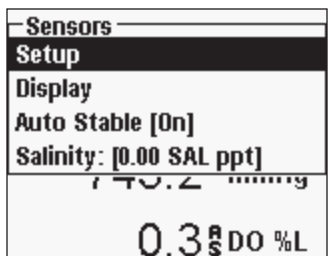
In this example, if the Sensitivity bar is set to the far right, the Auto Stable requirement would not be met and AS would continue to blink. However, if the sensitivity bar is set to the median threshold (1.275%), the Auto Stable requirement would be met and AS would display steadily on the display.


Within the Auto Stable menu, you can also choose to **Hold All Readings** for as many parameters as you set for Auto Stable. For instance, if DO and pH have



Auto Stable and Hold All Readings enabled, then the display will hold the readings once DO and pH have both reached their Auto Stable settings. You must press the **Esc** key to “release” the held display in order to take subsequent readings **Hold All Readings** must be reactivated after each use!

## SALINITY CORRECTION



The last feature in the **Sensor** menu is the **Salinity** correction value which is used to calculate the dissolved oxygen mg/L and ammonia readings when a conductivity sensor is not in use. Press **Sensor** , highlight **Salinity**, and press enter. Then, use the numeric entry screen to enter the Salinity value of the water you will be testing from 0 to 70 ppt.

If using a cable with a conductivity sensor, the salinity measured by the conductivity sensor will be used in the DO and ammonia mg/L calculations and ‘As Measured’ will be displayed next to **Salinity** in the Sensor menu.

As the salinity of water increases, its ability to dissolve oxygen decreases. For example, fully oxygenated 20 °C water at sea level with zero salinity will hold 9.092 mg/L of dissolved oxygen. If that same sample had a salinity value of 9 ppt, then it would hold 8.621 mg/L of dissolved oxygen. Therefore, to obtain accurate mg/L readings, it is important to know the salinity of the water you will be testing and to input that value into the instrument. The salinity of fresh water is typically 0-0.5 ppt and seawater is typically 35 ppt. You will also have the opportunity to enter or modify the Salinity correction value during DO calibration.

## CALIBRATION - DISSOLVED OXYGEN

The Pro Plus offers several options for calibrating dissolved oxygen: DO% in water saturated air, DO mg/L and DO ppm in a solution of known dissolved oxygen determined by a Winkler Titration, and a Zero point. If performing a zero point calibration, you must also perform a %, mg/L, or ppm calibration following the zero calibration. For both ease of use and accuracy, YSI recommends performing the following 1-point DO % water saturated air calibration:



*It is not necessary to calibrate in both % and mg/L or ppm. Calibrating in % will simultaneously calibrate mg/L and ppm and vice versa.*

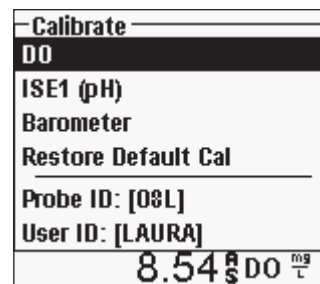
### Calibrating DO % in Water Saturated Air:


#### 1-Point Calibration

The supplied sensor storage container (a grey sleeve for a single port cable or a screw on plastic cup for the dual-port and Quattro cables) can be used for DO calibration purposes.

Moisten the sponge in the storage sleeve or plastic cup with a small amount of clean water. The sponge should be clean since bacterial growth may consume oxygen and interfere with the calibration. If using the cup and you no longer have the sponge, place a small amount of clean water (1/8 inch) in the plastic storage cup instead.

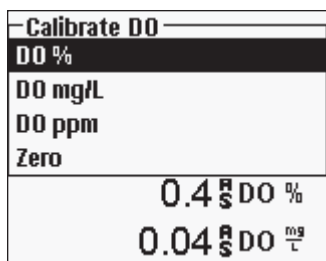
Make sure there are no water droplets on the DO membrane or temperature sensor. Then install the storage sleeve or cup over the sensors. The storage sleeve ensures venting to the atmosphere. If using the cup, screw it on the cable and then disengage one or two threads to ensure atmospheric venting. Make sure the DO and temperature sensors are not immersed in water. Turn the instrument on and wait approximately 5 to 15 minutes for the storage container to become completely saturated and to allow the sensors to stabilize.



Press **Cal** . Highlight Probe ID or User ID if you wish to add, select, edit, or delete an ID. Probe ID must be enabled in the System GLP menu to appear in the Calibrate menu. User ID will appear automatically. Select ‘None’ if you do not want a User ID stored with the calibration. When enabled, these IDs are stored with each calibration record in the GLP file.

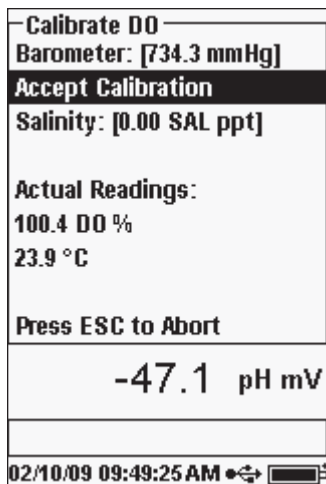


After selecting your User ID and/or Probe ID if appropriate, highlight DO and press enter.



Highlight **DO %** and press enter to confirm.

The instrument will use the internal barometer during calibration and will display this value in brackets at the top of the display. Highlight **Barometer** and press enter to adjust it if needed. If the barometer reading is incorrect, it is recommended that you calibrate the barometer. Note - the barometer should be reading “true” barometric pressure (see Barometer section for more information on “true” barometric pressure). If the value is acceptable, there is no need to change it or perform a barometer calibration.



The Salinity value displayed near the top of the screen is either the salinity correction value entered in the Sensor menu or the Salinity value as measured by the conductivity sensor in use and enabled. If you are not using a conductivity sensor, the Salinity correction value should be the salinity of the water you will be testing. Highlight **Salinity** and press enter to modify this setting if necessary. See the **Salinity Correction** section of this manual for more information.

Wait for the temperature and DO% values under “Actual Readings” to stabilize, then highlight **Accept Calibration** and press enter to calibrate. Or, press Esc **Esc** to cancel the calibration. If User Field 1 or 2 are enabled in the GLP menu, you will be prompted to select these inputs and then press Cal **Cal** to complete the calibration. The message line at the bottom of the screen will display “Calibrating Channel...” and then “Saving Configuration...”.

---

## Calibrating DO% in Water Saturated Air: 2-Point Calibration with Zero Solution

---

Place the sensor in a solution of zero DO.

A zero DO solution can be made by dissolving approximately 8 - 10 grams of sodium sulfite (Na<sub>2</sub>SO<sub>3</sub>) into 500 mL tap water or DI water. Mix the solution thoroughly. It may take the solution 60 minutes to be oxygen-free.

Press Cal **Cal**. Highlight Probe ID or User ID if you wish to add, select, edit, or delete an ID. Probe ID must be enabled in the System GLP menu to appear in the Calibrate menu. When enabled, these IDs are stored with each calibration record in the GLP file.

After selecting the Probe ID and/or User ID if appropriate, highlight DO and press enter. Highlight **Zero** and press enter. Wait for the temperature and DO% values under “Actual Readings” to stabilize, then press enter to **Accept Calibration**. If User Field 1 or 2 are enabled, you will be prompted to select the fields and then press Cal **Cal** to complete the calibration. The screen will then prompt for a follow-up second point calibration.

Highlight **DO%** and press enter to continue with the next calibration point. Rinse the sensor of any zero oxygen solution using clean water. Then follow the steps under Calibrating DO % in Water Saturated Air to complete the second point.

---

## Calibrating in mg/L or ppm as a Titration: 1-Point Calibration

---

Place the sensor into an adequately stirred sample that has been titrated to determine the dissolved oxygen concentration. Allow the sensor to stabilize.

Press Cal **Cal**. Highlight Probe ID or User ID if you wish to add, select, edit, or delete an ID. Probe ID must be enabled in the System GLP menu to appear in the Calibrate menu. When enabled, these IDs are stored with each calibration record in the GLP file.

After selecting the Probe ID and/or User ID if appropriate, highlight DO and press enter. Highlight **DO mg/L or ppm** and press enter.

Calibrate DO
Calibration value: [10.57]
Accept Calibration
Actual Readings:
10.57 DO mg/L
24.1 °C
Press ESC to Abort
7.61 pH
-47.0 pH mV

Highlight **Calibration value** and press enter to manually input the sample's dissolved oxygen value. Highlight **Accept Calibration** and press enter once the temperature and Dissolved Oxygen readings stabilize. Or, press Esc **Esc** to cancel the calibration. If User Field 1 or 2 are enabled in the GLP menu, you will be prompted to select the fields after selecting **Accept Calibration**. After making your selection, press Cal **Cal** to complete the calibration. After completing the calibration, the message line will display "Calibrating Channel..." and then "Saving Configuration..."

Calibrating in mg/L or ppm as a Titration:

### 2-Point Calibration with Zero Solution

Place the sensor in a solution of zero DO.

A zero DO solution can be made by dissolving approximately 8 - 10 grams of sodium sulfite (Na<sub>2</sub>SO<sub>3</sub>) into 500 mL tap water. Mix the solution thoroughly. It may take the solution 60 minutes to be oxygen-free.

Press Cal **Cal**. Highlight Probe ID or User ID if you wish to add, select, edit, or delete an ID. Probe ID must be enabled in the System GLP menu to appear in the Calibrate menu. When enabled, these IDs are stored with each calibration record in the GLP file.

After selecting the Probe ID and/or User ID if appropriate, highlight DO and press enter. Highlight **Zero** and press enter. Wait for the temperature and DO% values under "Actual Readings" to stabilize, then press enter to **Accept Calibration**. If User Field 1 or 2 are enabled, you will be prompted to select the fields and then Press Cal **Cal** to complete the calibration. The screen will then prompt for a follow-up second point calibration.

Highlight the desired calibration units (mg/L or ppm) and press enter to continue with the next point. Rinse the sensor of any zero oxygen solution using clean water. To complete the second calibration point, follow the steps under Calibrating in mg/L or ppm as a Titration: **1-Point Calibration**.

## BAROMETER

All Professional Plus instruments contain an internal barometer.

### DISPLAY - BAROMETER

Press Sensor **↓**, highlight **Display** and press enter. Highlight **Barometer** and press enter. The measurement unit options are: mmHg, inHg, mBar, PSI, kPa, or Atm. Only one unit can be displayed at a time. Select **None** if you do not want to display a barometric pressure reading.

Whether or not you choose to display the barometer reading, the barometric pressure will still be used for calibrating DO% and for compensating for pressure changes if **Local DO** is enabled.

### CALIBRATION - BAROMETER

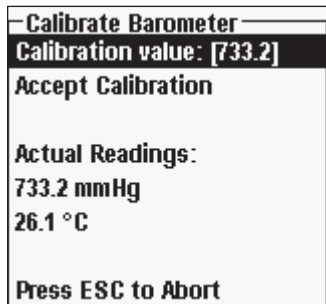
Calibrate
DO
ISE1 (pH)
Barometer
Restore Default Cal
Probe ID: [O&L]
User ID: [LAURA]
7.71 $\frac{mg}{L}$ DO $\frac{mg}{L}$



The barometer in the instrument is calibrated at the factory. If the barometer requires calibration, press Cal **Cal**. Highlight Probe ID or User ID if you wish to add, select, edit, or delete an ID. Probe ID must be enabled in the System GLP menu to appear in the Calibrate menu. When enabled, these IDs are stored with each calibration record in the GLP file.


After selecting the Probe ID and/or User ID if appropriate, highlight **Barometer** and press enter.

Calibrate Barometer
mmHg
inHg
mbars
PSI
kPa
atm
7.72 $\frac{mg}{L}$ DO $\frac{mg}{L}$

Highlight the desired unit and press enter.



Highlight **Calibration Value** and press enter to manually enter the correct “true” barometric pressure. Next, highlight **Accept Calibration**, and press enter. If User Field 1 or 2 are enabled, you will be prompted to select the fields and then press Cal  to complete the calibration or press Esc  to cancel the calibration.

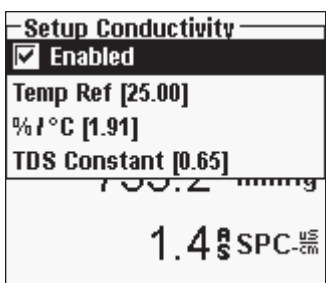
 *Laboratory barometer readings are usually “true” (uncorrected) values of air pressure and can be used “as is” for barometer calibration. Weather service readings are usually not “true”, i.e., they are corrected to sea level, and therefore cannot be used until they are “uncorrected”. An approximate formula for this “uncorrection” is below:*

$$\text{True BP} = [\text{Corrected BP}] - [2.5 * (\text{Local Altitude in ft. above sea level}/100)]$$

## CONDUCTIVITY


Conductivity sensors are supplied with 60530-X, 6051030-X, 6052030-X, and Quatro cables. Conductivity sensors are built into the 60530-X, 6051030-X, and 6052030-X cables and are not replaceable. Conductivity/Temperature sensors are shipped with the Quatro cable, must be installed, and are replaceable.

### SETUP - CONDUCTIVITY



Press Sensor , highlight **Setup**, and press enter. Highlight **Conductivity**, press enter.

**Enabled** allows you to enable or disable the conductivity measurement. Highlight **Enabled** and press enter to activate () or deactivate () conductivity. Disable conductivity if you do not have a conductivity sensor connected to the instrument.

 *If a sensor is Enabled that isn't connected to the instrument, the display will show an unstable, false reading next to the units.*


**Temp Ref (Temperature Reference)** is the reference temperature used for calculating temperature compensated Specific Conductance. This will be the

temperature all Specific Conductance values are compensated to. The default is 25 °C. To change the Reference Temperature, highlight **Temp Ref** and press enter. Use the numeric entry screen to enter a new value between 15.00 and 25.00 °C. Next, highlight <<<ENTER>>> at the bottom of the screen and press enter on the keypad to confirm.

**%/°C (Percent per Degree Celsius)** is the temperature coefficient used to calculate temperature compensated Specific Conductance. The default is 1.91% which is based on KCl standards. To change the temperature coefficient, highlight **%/°C** and press enter. Use the numeric entry screen to enter a new value between 0 and 4%. Next, highlight <<<ENTER>>> at the bottom of the screen and press **Enter** on the keypad to confirm.


**TDS Constant** is a multiplier used to calculate an estimated TDS (Total Dissolved Solids) value from conductivity. The multiplier is used to convert Specific Conductance in mS/cm to TDS in g/L. The default value is 0.65. This multiplier is highly dependent on the nature of the ionic species present in the water sample. To be assured of moderate accuracy for the conversion, you must determine a multiplier for the water at your sampling site. Use the following procedure to determine the multiplier for a specific sample:

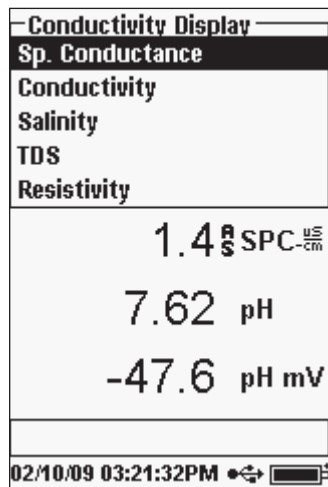
1. Determine the specific conductance of a water sample from the site;
2. Filter a portion of water from the site;
3. Completely evaporate the water from a carefully measured volume of the filtered sample to yield a dry solid;
4. Accurately weigh the remaining solid;
5. Divide the weight of the solid (in grams) by the volume of water used (in liters) to yield the TDS value in g/L for this site; Divide the TDS value in g/L by the specific conductance of the water in mS/cm to yield the conversion multiplier. Be certain to use the correct units.

 *If the nature of the ionic species at the site changes between sampling studies, the TDS values will be in error. TDS cannot be calculated accurately from specific conductance unless the make-up of the chemical species in the water remains constant.*

To change the multiplier, highlight **TDS Constant** and press enter. Use the numeric entry screen to enter a new value between 0 and 0.99. Highlight <<<ENTER>>> at the bottom of the screen and press **Enter** on the keypad to confirm.

## DISPLAY - CONDUCTIVITY

Press Sensor , highlight **Display** and press enter. Highlight **Conductivity** and press enter. Highlight **Sp. Conductance** (Specific Conductance), **Conductivity**, **Salinity**, **TDS**, or **Resistivity**, and press enter to select the reporting units for each parameter. One reporting unit per parameter may be enabled. To disable a parameter, select **None**. You will not be able to display any of these parameters unless the Conductivity sensor is **Enabled** in the Sensor Setup menu first.



**Sp. Conductance** can be displayed in us/cm or ms/cm. Specific conductance is temperature compensated conductivity.


**Conductivity** can be displayed in uS/cm or mS/cm. Conductivity is the measure of a solution's ability to conduct an electrical current. Unlike specific conductance, conductivity is a direct reading without any temperature compensation.

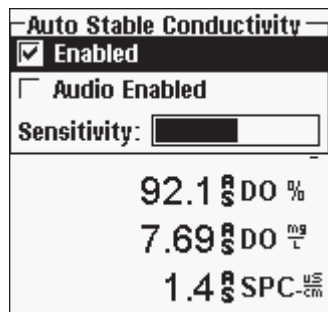
**Salinity** can be displayed in ppt (parts per thousand) or PSU (practical salinity units). The units are equivalent as both use the Practical Salinity Scale for calculation.

**TDS** can be displayed in mg/L (milligrams per liter), g/L (grams per liter), or kg/L (kilograms per liter).

**Resistivity** can be displayed in ohm-cm (ohms per centimeter), kohm-cm (kilo ohms per centimeter), or Mohm-cm (mega ohms per centimeter).

## AUTO STABLE - CONDUCTIVITY

Press Sensor , highlight **Auto Stable** and press enter. Highlight **Conductivity** and press enter.

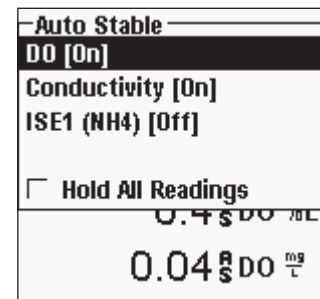


**Auto Stable** indicates when a reading is stable. Highlight **Enabled** and/or **Audio Enabled** (instrument will beep when the stability is achieved) and press enter enable () or disable (). When Auto Stable is enabled, **AS** will blink next to the parameter until it is stable. Once the parameter is stable, **AS** will stop blinking.

The Auto Stable **Sensitivity** can be decreased or increased. Highlight **Sensitivity** and use the left and right arrow keys to slide the bar. The more sensitive you make it (larger black bar) the harder it is to achieve stability in a changing environment.

The **Auto Stable** system works by examining the previous 5 readings, computing the percent change in the data and comparing that change against a % threshold value. The % threshold value is determined by the **Sensitivity** bar setting. The following chart can be used as a guide when setting the Sensitivity bar.

<i>Sensitivity selected by User</i>	<i>% Data Variance Threshold</i>
100 - Most Sensitive, Sensitivity bar is set to the far right	0.025%
75	0.39375%
50	0.7625%
25	1.13125%
0 - Least Sensitive, Sensitivity bar is set to the far left	1.5%



Within the Auto Stable menu, you can also choose to **Hold All Readings** for as many parameters as you set for Auto Stable. For instance, if conductivity and DO have Auto Stable and Hold All Readings enabled, then the display will hold the readings once conductivity and DO have both reached their Auto Stable settings. You must press the **Esc** key to “release” the held display in order to take subsequent readings. **Hold All Readings** must be reactivated after each use!

## CALIBRATION - CONDUCTIVITY



The 6051030 ISE/conductivity cable has a specialized calibration container that resembles a large test tube. This calibration chamber can be used to calibrate the conductivity sensor with an ISE sensor installed. A ring-stand should be used to support this chamber.

Calibrate
DO
<b>Conductivity</b>
ISE1 (pH)
Barometer
Restore Default Cal
Probe ID: [0%L]
User ID: [LAURA]
1.4 S SPC-cm
7.61 pH
-47.4 pH mV
Last Calibrated: 02/03/09
02/10/09 04:21:10PM

Press Cal . Highlight Probe ID or User ID if you wish to add, select, edit, or delete an ID. Probe ID must be enabled in the System GLP menu to appear in the Calibrate menu. User ID will appear automatically. Select 'None' if you do not want a User ID stored with the calibration. When enabled, these IDs are stored with each calibration record in the GLP file.

After selecting the User ID and/or Probe ID if appropriate, highlight **Conductivity** and press enter.

Calibrate Conductivity
<b>Sp. Conductance</b>
Conductivity
Salinity
733.3 mmHg
91.9% DO %
7.67% DO mg/L

Highlight the desired calibration method; **Sp. Conductance**, **Conductance**, **Conductivity**, or **Salinity** and press enter. YSI recommends calibrating in specific conductance for greatest ease.

### Calibrating in Specific (Sp.) Conductance or Conductivity

Place the sensor into a fresh, traceable conductivity calibration solution. The solution must cover the holes of the conductivity sensor that are closest to the cable. Ensure the entire conductivity sensor is submerged in the solution or the instrument will read approximately of half the expected value!

Calibrate Sp. Conductance
<b>SPC-uS/cm</b>
SPC-mS/cm
733.2 mmHg
91.8% DO %

Choose the units in either **SPC-us/cm**, **C-us/cm** or **SPC-ms/cm**, **C-ms/cm** and press enter.

Calibrate Sp. Conductance
<b>Calibration value: [1.4]</b>
<b>Accept Calibration</b>
Actual Readings:
1.4 SPC-uS/cm
24.5 °C
Press ESC to Abort
7.65 pH

Highlight **Calibration value** and press enter to input the value of the calibration standard. Then, once the temperature and conductivity readings stabilize, highlight **Accept Calibration** and press enter. Or, press Esc to cancel the calibration. If User Field 1 or 2 are enabled in the GLP menu, you will be prompted to select the fields and then press Cal to complete the calibration. After completing the calibration, the message line at the bottom of the screen will display "Calibrating Channel..." and then "Saving Configuration..."

### Calibrating in Salinity

Place the sensor into a salinity calibration solution. The solution must cover the holes of the conductivity sensor that are closest to the cable. Ensure the entire conductivity sensor is submerged in the solution or the instrument will read approximately of half the expected value!

Calibrate Salinity
<b>SAL ppt</b>
SAL PSU
733.3 mmHg
91.9% DO %

Select **SAL ppt** or **SAL PSU** and press enter.

Calibrate Salinity
<b>Calibration value: [0.00]</b>
<b>Accept Calibration</b>
Actual Readings:
0.00 SAL ppt
24.6 °C
Press ESC to Abort

Highlight **Calibration value** and press enter to input the value of the calibration standard. Then, once the temperature and conductivity readings stabilize, highlight **Accept Calibration** and press enter. Or, press Esc to cancel the calibration. If User Field 1 or 2 are enabled, you will be prompted to select the fields and then press Cal to complete the calibration.


## pH

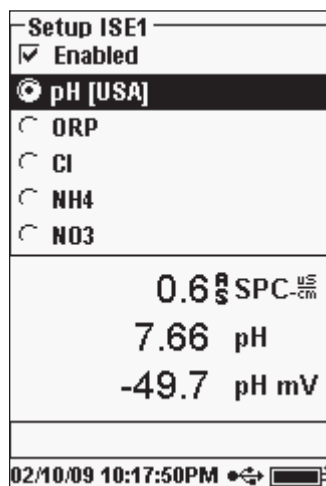
pH sensors can be used on 60510-X, 6051020-X, 6051030-X, 6051010-X, and Quatro cables.

If using a 605103 pH/ORP combination sensor on a 6051020 or 6051030 cable you can report both pH and ORP by configuring ISE1 as pH and ISE2 as ORP in the Sensor Setup menu.

The 605103 pH/ORP combination sensor is not recommended for use on a 6051010 or Quatro cable. If used on one of these cable, only pH will be reported and ORP will not be measured.

### SETUP - pH

Press Sensor , highlight **Setup**, press enter. Highlight **ISE1** if using a 60510, 6051020, or 6051030 cable. If using a 6051010 or Quatro cable, highlight **ISE1** if the pH sensor is installed in port 1 or highlight **ISE2** if the pH sensor is installed in port 2(a sensor must be installed in port 1 for port 2 to operate). Press enter.



**Enabled** allows you to enable or disable the ISE function and select which ISE sensor is installed on the cable. Highlight **Enabled** and press enter to enable () or disable () the ISE you selected previously (either ISE1 or ISE2). Disable the ISE function(s) if you do not have a ISE sensor connected to the instrument.

After enabling the ISE function, ensure that it is set to pH as shown in the left screen shot. If necessary, highlight pH and press enter to set the ISE to pH.

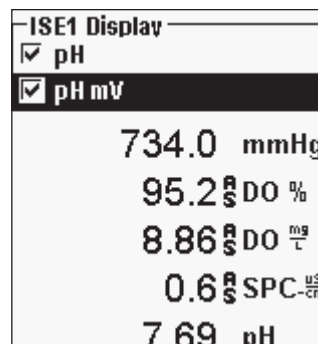
Highlighting **pH[USA]** and pressing enter will also allow you to select the values for auto buffer recognition which are used during calibration. The buffer options are **USA** (4, 7,

10), **NIST** (4.01, 6.86, 9.18), and **User-Defined**. The selected option will be displayed in [brackets].



*If a sensor is Enabled that isn't connected to the instrument, the display will show an unstable false reading, ?????, or ----- next to the units.*

### DISPLAY - pH




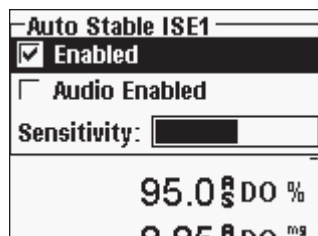
Press Sensor , highlight **Display** and press enter.

Highlight **ISE (pH)** and press enter. You will not be able to **Display** the sensor unless it is **Enabled** in the Sensor Setup menu.

Highlight **pH** and/or **pH mV**, press enter to enable () or disable (). Both can be reported at the same time.

### AUTO STABLE - pH

Press Sensor , highlight **Auto Stable** and press enter. Highlight **ISE (pH)** and press enter.

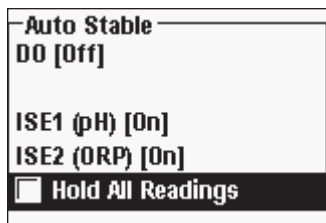


**Auto Stable** indicates when a reading is stable. Highlight **Enabled** and/or **Audio Enabled** (instrument will beep when the stability is achieved) and press enter enable () or disable (). When Auto Stable is enabled, **AS** will blink next to the parameter until it is stable. Once the parameter is stable, **AS** will stop blinking.

The Auto Stable **Sensitivity** can be decreased or increased. Highlight **Sensitivity** and use the left and right arrow keys to slide the bar. The more sensitive you make it (larger black bar) the harder it is to achieve stability in a changing environment.

The **Auto Stable** system works by examining the previous 5 readings, computing the percent change in the data and comparing that change against a % threshold value. The % threshold value is determined by the **Sensitivity** bar setting. The following chart can be used as a guide when setting the Sensitivity bar.

Sensitivity selected by User	% Data Variance Threshold
100 - Most Sensitive, Sensitivity bar is set to the far right	0.025%
75	0.39375%
50	1.5%
25	1.13125%
0 - Least Sensitive, Sensitivity bar is set to the far left	0.15%



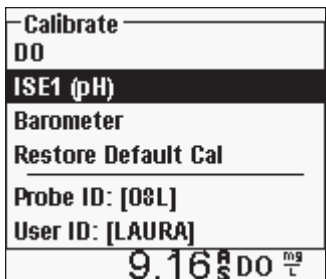
Within the Auto Stable menu, you can also choose to **Hold All Readings** for as many parameters as you set for Auto Stable. For instance, if ORP and pH have Auto Stable enabled and Hold All Readings is enabled, then the display will hold the readings once ORP and pH have both reached their Auto Stable settings. You must press the **Esc** key to “release” the held display in order to take subsequent readings.

**Hold All Readings** must be reactivated after each use!

## CALIBRATION - pH



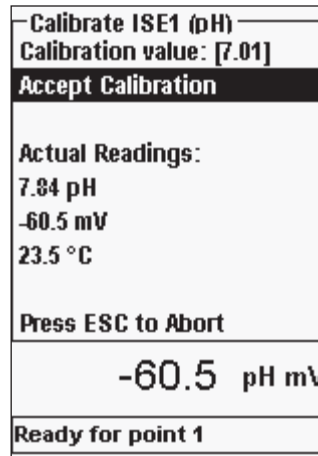
*Calibration can be accomplished in any buffer order. pH 7 buffer should be used regardless of how many calibration points you use but it does not have to be used first.*



Press **Cal** . Highlight Probe ID or User ID if you wish to add, select, edit, or delete an ID. Probe ID must be enabled in the System GLP menu to appear in the Calibrate menu. User ID will appear automatically. Select ‘None’ if you do not want a User ID stored with the calibration. When enabled, these IDs are stored with each calibration record in the GLP file.

After selecting your User ID and/or Probe ID if appropriate, highlight **ISE (pH)** and press enter. The message line will show the instrument is “Ready for point 1”. The pH calibration allows up to six calibration points.

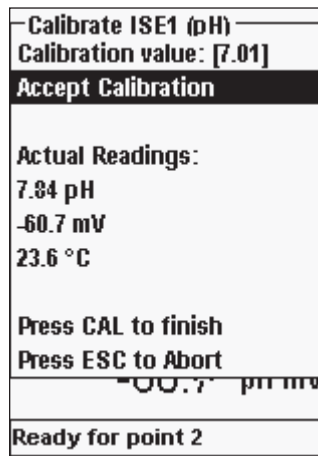
Place the sensor in a traceable pH buffer solution. The instrument should automatically recognize the buffer value and display it at the top of the calibration screen. If the calibration value is incorrect, the auto buffer recognition setting



in the Sensor Setup menu may be incorrect. If necessary, highlight the **Calibration Value** and press enter to input the correct buffer value.

Once the pH and temperature readings stabilize, highlight **Accept Calibration** and press enter to accept the first calibration point. The message line will then display “Ready for point 2”.

If you do not wish to perform a second point, press **Cal** to finalize the calibration. Or, press **Esc** to cancel the calibration. If User Field 1 or 2 are enabled, you will be prompted to select these fields and then press **Cal** to finalize the calibration.



To continue with the 2nd point, place the sensor in the second buffer solution. The instrument should automatically recognize the second buffer value and display it at the top of the screen. If necessary, highlight the **Calibration Value** and press enter to input the correct buffer value. Once the pH and temperature readings stabilize, highlight **Accept Calibration** and press enter to confirm the second calibration point. The message line will then display ‘Ready for point 3’ and you can continue with the 3rd calibration point if desired.

If you do not wish to perform a 3rd calibration point, press **Cal** to complete the calibration. If User Field 1 or 2 are enabled, you will be prompted to select these fields and then press **Cal** to finalize the calibration.

Continue in this fashion until the desired number of calibration points is achieved (up to six).



*Once you've achieved the desired number of cal points you must press **Cal** to finalize the calibration and to allow the instrument to update the pH offset and slope. The instrument will not take these cal values into account until Cal has been pressed.*



The actual readings displayed during the calibration will NOT reflect the updated calibration information. These values will not change until Cal is pressed to finalize the calibration and to update the instrument.

## ORP

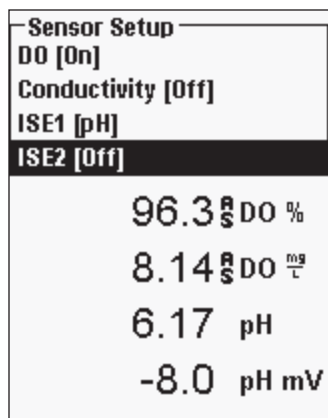
ORP sensors can be used on 60510-X, 6051020-X, 6051030-X, 6051010-X, and Quatro cables.

If using a 605103 pH/ORP combination sensor on a 6051020 or 6051030 cable you can report both pH and ORP by configuring ISE1 as pH and ISE2 as ORP in the Sensor Setup menu.

The 605103 pH/ORP combination sensor is not recommended for use on a 6051010 or Quatro cable. If used on one of these cable, only pH will be reported and ORP will not be measured.

## SETUP - ORP

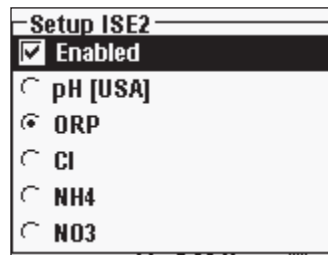
Press Sensor , highlight **Setup**, press enter.



Highlight **ISE1** if using a 605102 (ORP sensor) on a 60510, 6051020, or 6051030 cable. Highlight **ISE2** is using a 605103 (pH/ORP sensor) on a 60510, 6051020, or 6051030 cable. If using a 6051010 or Quatro cable, highlight **ISE1** if the ORP sensor is installed in port 1 or highlight **ISE2** if the ORP sensor is installed in port 2 (a sensor must be installed in port 1 for port 2 to operate). Press enter.

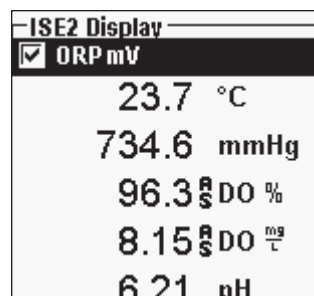
**Enabled** allows you to enable or disable the ISE function and select which ISE sensor is installed on the cable. Highlight **Enabled** and press enter to enable () or disable () the ISE you selected previously (either ISE1 or ISE2).

After enabling the ISE function, ensure ORP is selected as the ISE sensor as shown in screen shot to the left. If necessary, highlight ORP and press enter to set the selected ISE to ORP.



If a sensor is Enabled that isn't connected to the instrument, the display will show an unstable false reading, ?????, or ----- next to the units.

## DISPLAY - ORP

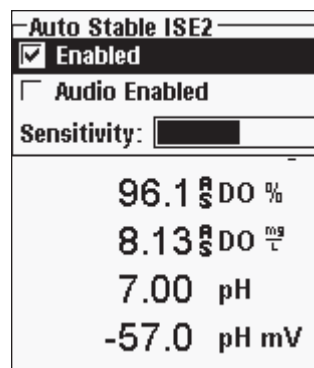



Press Sensor , highlight **Display** and press enter.

Highlight **ISE (ORP)** and press enter. You will not be able to **Display** the sensor unless it is **Enabled** in the Sensor Setup menu.

Press enter to enable () or disable () **ORP mV**.

## AUTO STABLE - ORP



Press Sensor , highlight **Auto Stable** and press enter. Highlight **ISE (ORP)** and press enter.

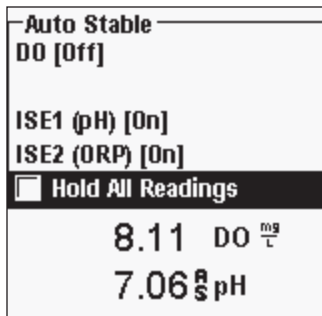
**Auto Stable** indicates when a reading is stable. Highlight **Enabled** and/or **Audio Enabled** (instrument will beep when the stability is achieved) and press enter enable () or disable (). When Auto Stable is enabled, **AS** will blink next to the parameter until it is stable. Once the parameter is stable, **AS** will stop blinking.

The Auto Stable **Sensitivity** can be decreased or increased. Highlight **Sensitivity** and use the left and right arrow keys to slide the bar. The more sensitive you make it (larger black bar) the harder it is to achieve stability in a changing environment.

The **Auto Stable** system works by examining the previous 5 readings, computing the percent change in the data and comparing that change against a % threshold value. The % threshold value is determined by the **Sensitivity** bar setting. The following chart can be used as a guide when setting the Sensitivity bar.

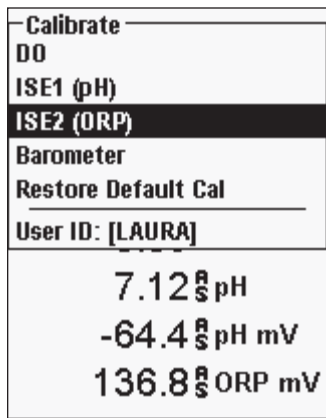


Sensitivity selected by User	% Data Variance Threshold
100 - Most Sensitive, Sensitivity bar is set to the far right	0.05%
75	0.62525%
50	1.275%
25	1.8875%
0 - Least Sensitive, Sensitivity bar is set to the far left	2.5%



Within the Auto Stable menu, you can also choose to **Hold All Readings** for as many parameters as you set for Auto Stable. For instance, if ORP and pH have Auto Stable enabled and Hold All Readings is enabled, then the display will hold the readings once ORP and pH have both reached their Auto Stable settings. You must press the **Esc** key to “release” the held display in order to take subsequent readings. **Hold All Readings** must be reactivated after each use!

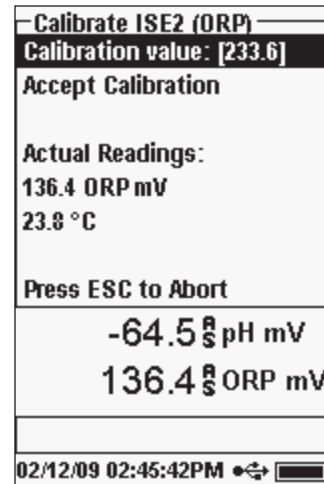
## CALIBRATION - ORP



Press **Cal**. Highlight Probe ID or User ID if you wish to add, select, edit, or delete an ID. Probe ID must be enabled in the System GLP menu to appear in the Calibrate menu. User ID will appear automatically. Select ‘None’ if you do not want a User ID stored with the calibration. When enabled, these IDs are stored with each calibration record in the GLP file.

After selecting your User ID and/or Probe ID if appropriate, highlight **ISE (ORP)** and press enter. The message line will show the instrument is “Ready for point”.

Place the sensor in a solution of known ORP and wait for the readings to stabilize.



Highlight **Calibration value** and press enter to input the value of the ORP calibration standard. If using the YSI Zobell calibration solution, the Pro Plus will automatically determine the calibration value. However, the calibration value should be verified against the chart on the side of the Zobell bottle. Next, once the temperature and ORP readings stabilize, highlight **Accept Calibration** and press enter to calibrate. Or, press **Esc** to cancel the calibration. If User Field 1 or 2 are enabled, you will be prompted to select the fields and then press **Cal** to complete the calibration.

## AMMONIUM, NITRATE, CHLORIDE

Ammonium, Nitrate, and Chloride sensors can be used on 60510-X, 6051020-X, 6051030-X, 6051010-X, and Quatro cables. These cables also accommodate pH and ORP sensors so instrument setup is important.



**WARNING:** Ammonium, Nitrate, and Chloride sensors should only be used at DEPTHS OF LESS THAN 55 FEET (17 METERS). Use of the sensors at greater depths is likely to permanently damage the sensor membrane.



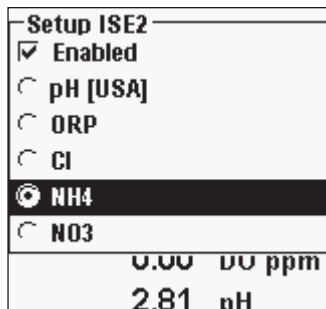
**WARNING:** Ammonium, Nitrate, and Chloride sensors should only be used in FRESHWATER.

## SETUP - AMMONIUM, NITRATE, CHLORIDE

Install the Ammonium, Nitrate, or Chloride sensor in Port 2 if using in conjunction with pH or ORP sensor on a 6051010 or Quatro cable. See the **Getting Started Setup** section of this manual for a complete list of cable/sensor configurations.

Press **Sensor**, highlight **Setup**, press enter. Highlight **ISE1** if using an ammonium, nitrate, or chloride sensor on a 60510, 6051020, or 6051030 cable.

If using a 6051010 or Quatro cable highlight **ISE1** if the sensor is installed in Port 1 or highlight **ISE2** if the sensor is installed in Port 2. Press enter.




**Enabled** allows you to enable or disable the ISE function and select which ISE sensor is installed on the cable.


Highlight **Enabled** and press enter to enable () or disable () the ISE you selected previously (either ISE1 or ISE2).

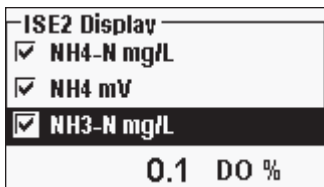
After enabling the ISE function, choose the parameter you want enabled for that ISE. In this example, NH4 is selected.

- Cl - Chloride
- NH4 - Ammonium
- NO3 - Nitrate

 *If a sensor is Enabled that isn't connected to the instrument, the display will show an unstable, false reading next to the units.*

## DISPLAY - AMMONIUM, NITRATE, CHLORIDE

Press Sensor , highlight **Display**, press enter. Highlight **ISE2(NH4)**, press enter. You will not be able to **Display** the sensor unless it is **Enabled**.



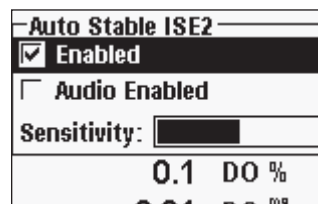
Highlight the value you wish to display and press enter to enable () . Ammonium can be displayed as NH4-N mg/L (Ammonium), NH3-N (Ammonia) and/or NH4 mV (sensor signal).


The same steps would be followed to display nitrate or chloride.

**Ammonia** is calculated from the pH, salinity, and temperature readings. If a pH sensor is not in use, the instrument will assume the sample is neutral (pH 7) for the calculation. If a conductivity sensor (Salinity) is not in use, the instrument will use the salinity correction value entered in the Sensor Menu for the calculation (see Salinity Correction within the Dissolved Oxygen Setup section of this manual for more information).

## AUTO STABLE - AMMONIUM, NITRATE, CHLORIDE

**Auto Stable** indicates when a reading is stable. When Auto Stable is enabled, **AS** will blink next to the parameter until it is stable. Once the parameter is stable, **AS** will stop blinking.



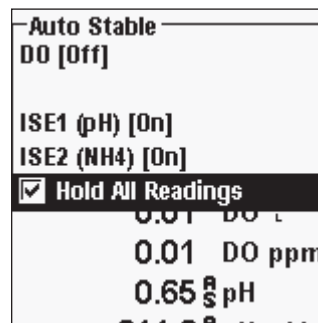
To enable Auto Stable, press Sensor , highlight **Auto Stable** and press enter. Highlight **ISE1** or **ISE2** and press enter.

Highlight **Enabled** and/or **Audio Enabled** (instrument will beep when the stability is achieved) and press enter to confirm. The Auto Stable **Sensitivity** can be decreased or increased.

Highlight **Sensitivity** and use the left and right arrow keys to slide the bar. The more sensitive you make it (larger black bar) the harder it is to achieve stability in a changing environment.

The **Auto Stable** system works by examining the previous 5 readings, computing the percent change in the data and comparing that change against a % threshold value. The % threshold value is determined by the **Sensitivity** bar setting. The following chart can be used as a guide when setting the Sensitivity bar.

<i>Sensitivity selected by User</i>	<i>% Data Variance Threshold</i>
100 - Most Sensitive, Sensitivity bar is set to the far right	0.05%
75	0.62525%
50	1.275%
25	1.8875%
0 - Least Sensitive, Sensitivity bar is set to the far left	2.5%



Within the Auto Stable menu, you can also choose to **Hold All Readings** for as many parameters as you set for Auto Stable. For instance, if pH and Ammonium have Auto Stable enabled and Hold All Readings is also enabled, then the display will hold the readings once pH and Ammonium have both reached their Auto Stable settings. You must press the **Esc** key to “release” the held display in order to take subsequent readings. **Hold All Readings** must be reactivated after each use!

---

## CALIBRATION - AMMONIUM, NITRATE, CHLORIDE

---

The 6051030 ISE/conductivity cable has a specialized calibration container that resembles a large test tube. This calibration chamber can be used to calibrate the ISE sensors with the conductivity sensor. A ring-stand should be used to support this chamber.



*The ISE sensors can be calibrated at 1, 2, or 3-points.*

**A 2-point calibration without chilling a third calibration solution is extremely accurate and is the preferred method.**

*Greatest accuracy is achieved if the actual samples to be measured are within 10 °C of the calibration solutions.*

**CALIBRATION TIP:** Exposure to the high ionic content of pH buffers can cause a significant, but temporary, drift in the ammonium, nitrate, and chloride ISE sensors. Therefore, when calibrating the pH sensor, YSI recommends that you use one of the following methods to minimize errors in the subsequent readings:

- When calibrating pH, remove ISE sensors from the cable bulkhead and plug the ports. After pH calibration is complete, replace the ISE sensors and proceed with their calibration with no stabilization delay.
- Calibrate pH first, immersing all of the sensors in the pH buffers. After calibrating pH, place the sensors in 100 mg/L nitrate or ammonium standard or 1000 mg/L chloride standard depending on the sensor in use and monitor the reading. Usually, the reading starts low and may take awhile to reach a stable value. When it does, proceed with the calibration. This may take several hours.

---

### Preparing Chloride Standards

---

The following recipes are provided for preparation of 10 and 1000 mg/L chloride reagents. Nitrate and Ammonium standards can be purchased from YSI or other laboratory supply companies.

It is important to note that some of the chemicals required for these solutions could be hazardous under some conditions. It is the responsibility of the user to obtain and study the MSDS for each chemical and to follow the required instructions with regard to handling and disposal of these chemicals.

You will need: Solid sodium chloride or a certified 1000 mg/L chloride solution from a supplier, magnesium sulfate, high purity water, a good quality analytical

balance, 1000 mL volumetric flask, an accurate 10 mL measuring devices, and 1000 mL glass or plastic storage vessels.

**1000 mg/L Standard:** Accurately weigh 1.655 grams of anhydrous sodium chloride and transfer into a 1000 mL volumetric flask. Add 0.5 grams of anhydrous magnesium sulfate to the flask. Add 500 mL of water to the flask, swirl to dissolve all of the reagents, and then dilute to the volumetric mark with water. Mix well by repeated inversion and then transfer the 1000 mg/L standard to a storage bottle. Rinse the flask extensively with water prior to its use in the preparation of the 10 mg/L standard. Alternatively, simply add 0.5 grams of magnesium sulfate to a liter of a 1000 mg/L chloride standard from a certified supplier.

**10 mg/L Standard:** Accurately measure 10 mL of the above 1000 mg/L standard solution into a 1000 mL volumetric flask. Add 0.5 grams of anhydrous magnesium sulfate to the flask. Add 500 mL of water, swirl to dissolve the solid reagents, and then dilute to the volumetric mark with water. Mix well by repeated inversion and then transfer the 10 mg/L standard to a storage bottle.

---


## AMMONIUM (NH<sub>4</sub><sup>+</sup>), NITRATE (NO<sub>3</sub><sup>-</sup>), AND CHLORIDE CL-2-POINT

---

The calibration procedures for ammonium, nitrate, or chloride are similar to pH. The only differences are the calibration solutions. Recommended values for calibration solutions and the order of calibration are as follows:

Sensor	1 <sup>st</sup> Point	2 <sup>nd</sup> Point
Ammonium-nitrogen (NH <sub>4</sub> -N)	1 mg/L	100 mg/L
Nitrate-nitrogen (NO <sub>3</sub> -N)	1 mg/L	100 mg/L
Chloride (Cl <sup>-</sup> )	10 mg/L	1000 mg/L

Place the proper amount of 1 mg/L standard for Ammonium or Nitrate (10 mg/l for Chloride) into a clean, dry or pre-rinsed calibration cup. Carefully immerse the sensor into the solution. Allow at least 1 minute for temperature equilibration before proceeding.

Press Cal . Highlight Probe ID or User ID if you wish to add, select, edit, or delete an ID. Probe ID must be enabled in the System GLP menu to appear in the Calibrate menu. User ID will appear automatically. Select 'None' if you do not want a User ID stored with the calibration. When enabled, these IDs are stored with each calibration record in the GLP file.




Calibrate ISE2 (NH4)
Calibration value: [10.00]
Accept Calibration
Salinity: [0.00 SAL ppt]
Actual Readings:
++++ NH4-N mg/L
312.3 mV
18.9 °C

After selecting your User ID and/or Probe ID if appropriate, highlight **Ammonium**, **Nitrate**, or **Chloride** to access the appropriate calibration, and press enter. The parameter you want to calibrate may appear under ISE1 or ISE2 depending on your cable type and setup. The message line will show the instrument is ready for the 1st calibration point.




The instrument will display the calibration value at the top of the screen. If necessary, highlight

the **Calibration value** and press enter to input the correct value.

Once the readings stabilize, highlight **Accept Calibration** and press enter to accept the first calibration point. The message line will then display “Ready for point 2”.

If you do not wish to perform a second point, press Cal  to finalize the calibration. If User Field 1 or 2 are enabled, you will be prompted to select these fields and then press Cal  to finalize the calibration. Alternatively, you may press Esc  to cancel the calibration.

To continue with the 2nd point, rinse the sensor with clean water, then dry it before placing it in the second calibration standard. Allow at least 1 minute for temperature equilibration before proceeding. The instrument will display the second calibration value at the top of the screen. If necessary, highlight the **Calibration value** and press enter to input the correct buffer value. Once the readings stabilize, highlight **Accept Calibration** and press enter to confirm the second calibration point. The message line will then display “Ready for point 3” and you can continue with the 3rd calibration point if desired.

If you do not wish to perform a 3rd calibration point, press Cal  to complete the calibration. If User Field 1 or 2 are enabled, you will be prompted to select these fields and then press Cal  to finalize the calibration. Alternatively, you may press Esc  to cancel the calibration.

---

## AMMONIUM (NH4+) , NITRATE (NO3-), AND CHLORIDE CL-3-POINT




---

**A 2-point calibration without chilling a third calibration solution is extremely accurate and is the preferred method.** If you must perform a 3-point calibration, the following procedure requires one portion of the high concentration calibration solution and two portions of the low concentration calibration solution. The

high concentration solution and one of the low concentration solutions should be at ambient temperature. The other low concentration solution should be chilled to less than 10 °C prior to calibration.



**WARNING:** *The chilled calibration solution MUST BE CHILLED TO AT LEAST 5 °C COOLER THAN THE 1ST CALIBRATION POINT, otherwise the 1st point will be OVERRIDDEN.*

Follow the procedure for a 2-point cal. After the second calibration point is complete, the message line will state ‘Ready for point 3’. Place the proper amount of chilled 1 mg/L standard (10 mg/L for the chloride) into a clean, dry or pre-rinsed calibration cup. Carefully immerse the sensor into the solution. Allow for temperature equilibration. If necessary, highlight **Calibration value** and press enter to manually enter the 3rd buffer value. Once the readings are stable, highlight **Accept Calibration** and press enter to confirm. Press Cal  to complete the calibration. If User Field 1 or 2 are enabled, you will be prompted to select these fields and then press Cal  to finalize the calibration. Alternatively, press Esc  to cancel the calibration.

## TAKING MEASUREMENTS

---

To obtain the most accurate readings, be sure the instrument is calibrated before taking measurements.

### DISSOLVED OXYGEN

---

Turn the instrument on and wait 5-15 minutes if using a polarographic sensor. If using a field cable/sensor, install the sensor guard to protect the sensor and membrane. Place the probe in the sample to be measured and give the probe a quick shake to release any air bubbles. Allow the temperature readings to stabilize. Next, stir the probe in the sample to overcome the stirring dependence of the dissolved oxygen sensor. You must provide at least 3 inches per second for 2.0 PE membranes, 6 inches per second for 1.25 PE membranes, and 12 inches per second for Teflon® membranes. Once the values plateau and stabilize, you may record the measurement and/or log the data set. The dissolved oxygen reading will drop over time if stirring is ceased.

If placing the DO sensor into a stream or fast flowing waters it is best to place it perpendicular to the flow and NOT facing into the flow.

If using the DO sensor in an aeration tank/basin, it is helpful to make sure bubbles do not burst on the membrane since this may cause unstable readings. You should be able to prevent this by pointing the sensor upwards so it's facing

the sky and then twist tying, zip tying, or rubber banding the bulkhead to the cable. Making a simple curve to the cable without bending or breaking the cable will allow you to lower the sensor into the aeration tank while the sensor points skyward so the bubbles are no longer bursting on the membrane surface.

## CONDUCTIVITY

The conductivity sensor will provide quick readings as long as the entire sensor is submerged and no air bubbles are trapped in the sensor area. Immerse the probe into the sample so the sensors are completely submerged and then shake the probe to release any air bubbles. Occasional cleaning of the sensor may be necessary to maintain accuracy and increase the responsiveness. To clean the sensor, use the conductivity cleaning brush with a mild detergent.

## pH/ORP

pH and ORP readings are typically quick and accurate. However, it may take the sensors a little longer to stabilize if they become coated or fouled. To improve the response time of a sensor, follow the cleaning steps in the Maintenance section of this manual.


## AMMONIUM, NITRATE, AND CHLORIDE

These sensors may take a little longer to stabilize if the tips are dirty or fouled. If installed with a pH sensor, always maintain a clean pH sensor for a more rapid sensor stabilization.

These sensors can only be used in freshwater.

## LOGGING DATA

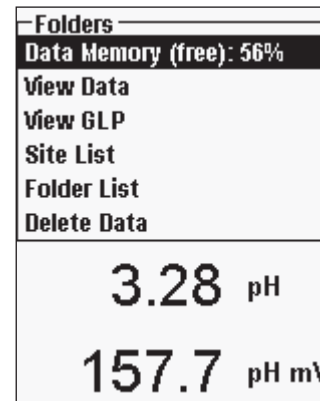
**Log One Sample** is already highlighted in Run mode. Press enter to open a submenu. If **Use Site List** and or **Use Folder List** are enabled in the Logging Setup menu, you will have to option to select these two items before the data point is logged. If necessary, use the keypad to create a new Site or Folder name. If Site List and Folder List are disabled in the **System** menu, you will not see these options when logging a sample. Once the Site and/or Folder name is selected, highlight **Log Now** and press Enter. The instrument will confirm that the data point was successfully logged.

If you would like to log at a specific interval vs. logging one sample at a time or vice versa, press **System** , then highlight **Logging** and press enter. Select **Continuous Mode** and adjust the time Interval if necessary. On the Run screen, the option to log will change from **Log One Sample** to **Start Logging** based on the time interval entered in the Logging Menu.

During a continuous log, the Start Logging dialog box on the Run screen will change to Stop Logging. Press Enter to stop continuous logging.

## FILES AND SITE LISTS

### FILE MEMORY

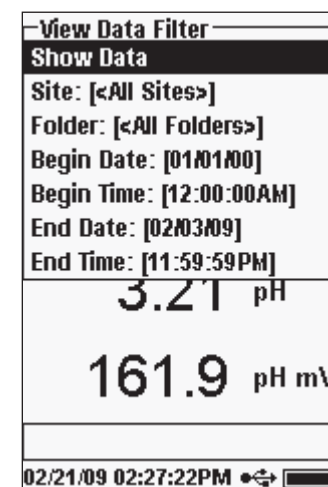


To view the file memory, press **File** .

The **Data Memory** shows a percentage indicating the amount of memory available. If the file memory is near 0%, files should be downloaded to a PC and/or deleted to free up memory.

### VIEWING SAVED DATA

Press **File** , highlight **View Data** and press enter.



Configuring your data view:

**Site:** will allow you to view data from one particular site or all sites. Highlight **Site**, press enter, and select the site you wish to view data from or select **All Sites** to view data from all sites.

**Folder:** will allow you to view data from one particular folder or all folders. Highlight **Folder**, press enter, and select the file you wish to view data from or select **All Folders** to view data from all folders.

**Begin Date, Begin Time, End Date, and End Time:** will allow you to view data collected between a specific time period. Highlight the

View Filtered Log Data		
<All Sites> <All Folders>		
	°C	mmHg DO
11/05/08		
03:07:41PM	24.5	735.2 91
03:07:43PM	24.5	735.3 91
03:07:44PM	24.5	735.2 91
03:07:45PM	24.5	735.3 91
03:07:45PM	24.5	735.2 91

11/21/08 04:15:16PM

time qualifier you would like to set, press enter, and use the numeric entry screen to select the date/time you wish to view.

After making your selections in the Data Filter, highlight **Show Data** and press enter. The data will have date and time stamps. You will likely have to scroll up and down and side to side using the arrow keys to completely view the data file. No more than 100 data records can be viewed at one time.

## SITE LIST

Site List
TANK1
TANK2
DOCK1
Add new...
744.5 mmHg

To modify the **Site List**, press **File**, highlight **Site List**, and press enter. Enter new site names or edit existing sites with the alpha/numeric entry screen. Site lists can also be created and edited on your PC with Data Manager and then downloaded to the instrument.

## FOLDER

To modify the **Folder List**, press **File**, highlight **Folder List**, and press enter. Enter new Folder names or edit existing folders with the alpha/numeric entry screen.

## DELETE DATA

Press **File**, highlight **Delete Data**, and press enter. Enter the criteria for the data you wish to delete in the Delete Data Filter, then highlight **Delete Data** and press enter.

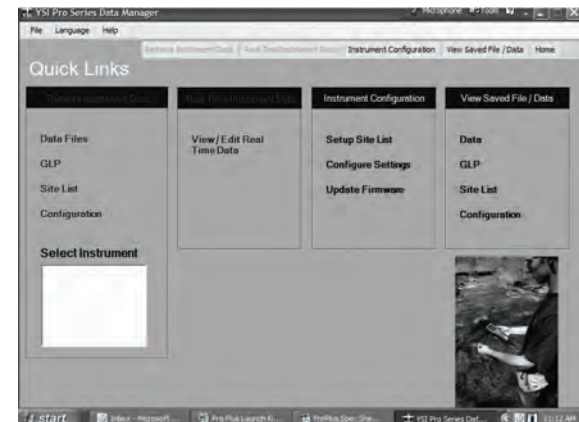
# DATA MANAGER DESKTOP SOFTWARE

Data Manager is provided with the purchase of a Pro Plus Instrument. Data Manager is a powerful Windows® based software that will allow you to easily manage logged data, set up instruments, and conduct real time studies.

Minimum PC system requirements for Data Manager are Windows® 2000 with SP4 (minimum) or Windows® XP with SP2 (minimum) Operating System, 300 MHz or higher Pentium®-compatible CPU, 128 MB of RAM or higher, 80 MB or more of free hard-disk space, USB 2.0, and Microsoft® .NET.

Data Manager needs to be installed on a PC before use and before you try to connect a Pro Plus to your PC. First install Data Manger, then connect the communications saddle to the PC and, lastly, connect the saddle to your Pro Plus. Data Manager will identify the connected instruments by their Unit ID. Refer to the Data Manager Readme file for detailed installation instructions. Data Manager will then recognize the attached instruments.

From the 'home' screen of Data Manager, see below, you can select one of the following functions: Retrieve Instrument Data, Real Time Instrument Data, Instrument Configuration, or View Saved File/Data.



## USING THE COMMUNICATIONS SADDLE



**WARNING:** DO NOT connect the Communications Saddle to your PC before installing Data Manager. The Communication Saddle drivers MUST be installed prior to connecting it to your PC. The drivers will install automatically during the Data Manager installation. The first time the saddle is connected to the PC, you may have to walk through a couple of installation wizards. For detailed instruction, please refer to the Readme file located on the CD that was included with your instrument.

A PC will recognize the Communications Saddle (saddle) as a YSI water quality instrument with or without the Pro Plus installed in the saddle.

To connect the saddle to a Pro Plus, simply align the saddle to the oval section on top of the instrument and push it down to snap it in place (Figure 6).

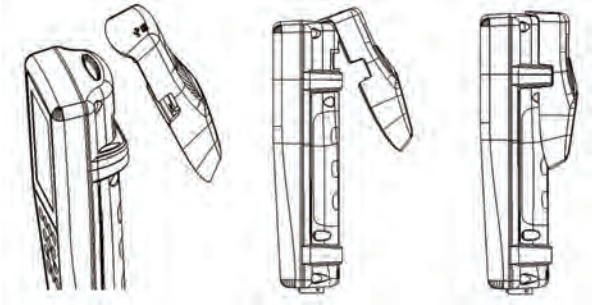


Figure 6. Locate the oval alignment groove at the top of the instrument and inside the saddle. Insert the saddle into this oval groove. Press the saddle towards the back of the instrument until it snaps into place.

Connect the USB cable to the top of the saddle and to a USB port on the PC. Once Data Manager is launched, the program will recognize all saddles with instruments connected to the PC.

The instrument will be powered through the saddle and USB connection when connected to the PC. However, the instrument must still have batteries installed in order to keep the date and time correct when powering the PC off at night. Make sure the instrument is turned off first, then turn off the PC to keep the instrument from running all night on the batteries. If you power it off and power off the PC the instrument will keep the correct date and time if it has batteries installed. If batteries are not installed, the instrument's date and time will not remain correct and will need to be reset each morning.

## MANAGE LOGGED DATA

Data that has been logged to the Professional Plus can easily be uploaded to the PC via the provided USB saddle. You can upload sensor data, GLP files, site lists, and instrument configuration files individually or all at once. After connecting the instrument to the PC via the USB saddle and cable and launching Data Manager, click the **Retrieve Instrument Data** tab. Click on the Instrument's Unit ID you would like to retrieve data from, then select the files you would like to retrieve and click Start.

Once the sensor data is uploaded to the PC, you can graph and view tabular data by instrument Unit ID, date/time, site name, and/or folder name. This allows you to configure the report according to your needs. You can choose to view all data from all instruments, or select a certain date/time range for only a few specific instruments, there are multiple ways to view the data. Once the report has been defined, you will be able to print the graph and/or export the table.

Data Manager takes information management one step further and allows you to delete specific points instead of entire files. This allows you to clean up data that is no longer needed or that may have been collected erroneously, for example, when the sensor was out of the water. If you can not delete data due to regulation and compliance purposes, Data Manager has the solution. While viewing logged data or real time data, you have the ability to 'tag' individual data points with comments.

In addition to sensor data, you will be able to view GLP files, site lists, and configuration files that have been uploaded from the instrument. These can be printed and exported as well.

## REAL TIME STUDIES

Data Manager allows you to view real time data on the PC.

After selecting your instrument, click the **Real Time Instrument Data** tab. Next, input your sample interval, site/folder name, select the parameters you wish to view and click **OK**. You must click **Start** on the next screen to begin your real time study. Choose to hide the table or graph by unchecking the box next to these options. Click **Stop**, then **Edit Setup** to change the Y-scale min/max of the graph, to select different colors, or to name your graph. Add a comment to a data point by clicking in the comment field of the table next to the data point. You may also **Print** the graph and **Export** the data for viewing in another program.

## CONFIGURE INSTRUMENTS

---

Data Manager allows for easy and quick configuration of single or multiple instruments. Once you have uploaded a site list or configuration file, you can edit it as needed, save it, and download it to other instruments. You no longer need to configure each instrument individually. By using the same configuration file for all instruments, you can rest assured that all instruments will have identical settings.

New site lists and configuration files can be created in Data Manager as well. These lists and files can be downloaded to one or multiple instruments. Save time by creating these files on your PC and downloading them to the instrument as opposed to creating them on the instrument.

## CARE, MAINTENANCE, AND STORAGE

---

This section describes the proper procedures for care, maintenance and storage of the sensors. The goal is to maximize their lifetime and minimize down-time associated with improper sensor usage.

### UPDATING INSTRUMENT FIRMWARE

---

The instrument's firmware can be updated via [www.ysi.com](http://www.ysi.com). There you will find the new firmware file and instructions on how to update the instrument. There is no need to send the instrument back to the factory for upgrades.

## GENERAL MAINTENANCE

---

### GENERAL MAINTENANCE - O-RINGS

---

The instrument utilizes o-rings as seals to prevent water from entering the battery compartment and sensor ports. Following the recommended procedures will help keep your instrument functioning properly.

If the o-rings and sealing surfaces are not maintained properly, it is possible that water can enter the battery compartment and/or sensor ports of the instrument. If water enters these areas, it can severely damage the battery terminals or sensor ports causing loss of battery power, false readings, and corrosion to the sensors or battery terminals. Therefore, when the battery compartment lid is removed, the o-ring that provides the seal should be carefully inspected for contamination (e.g. debris, grit, etc.) and cleaned if necessary.

The same inspection should be made of the o-rings associated with the sensor connectors when they are removed. If no dirt or damage to the o-rings is evident, then they should be lightly greased without removal from their groove. However, if there is any indication of damage, the o-ring should be replaced with an identical o-ring. At the time of o-ring replacement, the entire o-ring assembly should be cleaned.

#### To remove the o-rings:

Use a small, flat-bladed screwdriver or similar blunt-tipped tool to remove the o-ring from its groove. Check the o-ring and the groove for any excess grease or contamination. If contamination is evident, clean the o-ring and nearby plastic parts with lens cleaning tissue or equivalent lint-free cloth. Alcohol can be used to clean the plastic parts, but use only water and mild detergent on the o-ring itself. Also, inspect the o-rings for nicks and imperfections.



*Using alcohol on o-rings may cause a loss of elasticity and may promote cracking. Do not use a sharp object to remove the o-rings. Damage to the o-ring or the groove may result.*

Before re-installing the o-rings, make sure to use a clean workspace, clean hands, and avoid contact with anything that may leave fibers on the o-ring or grooves. Even a very small amount of contamination (hair, grit, etc.) may cause a leak.

#### To re-install the o-rings:

Place a small amount of o-ring grease between your thumb and index finger. (More grease is NOT BETTER!)

Draw the o-ring through the grease while pressing the fingers together to place a very light covering of grease to the o-ring. Place the o-ring into its groove making sure that it does not twist or roll.

Use your grease-coated finger to once again lightly go over the mating surface of the o-ring.



*Do not over-grease the o-rings. The excess grease may collect grit particles that can compromise the seal. Excess grease can also cause the waterproofing capabilities of the o-ring to diminish, potentially causing leaks. If excess grease is present, remove it using a lens cloth or lint-free cloth.*



---

## GENERAL MAINTENANCE - SENSOR PORTS

---

It is important that the entire sensor connector end be dry when installing, removing or replacing. This will prevent water from entering the port. Once a sensor is removed, examine the connector inside the port. If any moisture is present, use compressed air to completely dry the connector or place directly in front of a steady flow of fresh air. If the connector is corroded, return the cable to your dealer or directly to an YSI Repair Center.



*Remove sensors upside down (facing the ground) to help prevent water from entering the port upon removal.*

---

## SENSOR MAINTENANCE

---

---

### SENSOR MAINTENANCE - DISSOLVED OXYGEN

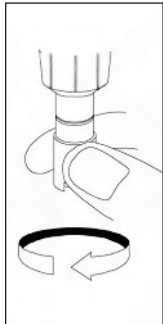
---

---

#### Membrane Cap Installation

---

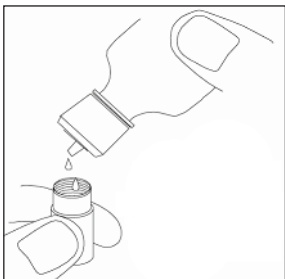
The DO sensor (Polarographic and Galvanic) is shipped with a dry, protective red cap that will need to be removed before using. Remove the protective cap or used membrane cap and replace it with a new membrane cap following these instructions:



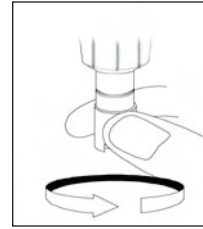
Remove the sensor guard to access the sensor tip.

Unscrew and remove any old membrane cap by holding the sensor when unscrewing the membrane cap and discard.

Thoroughly rinse the sensor tip with distilled or DI water.



Fill a new membrane cap with O<sub>2</sub> sensor electrolyte solution that has been prepared according to the directions on the bottle. Be very careful not to touch the membrane surface. Lightly tap the side of the membrane cap to release bubbles that may be trapped.



Thread the membrane cap onto the sensor. It is normal for a small amount of electrolyte to overflow.

---

### Polarographic Sensors - Model # 605203

---

The KCl (potassium chloride) solution and the membrane cap should be changed at least once every 30 days during regular use. In addition, the KCl solution and membrane should be changed if (a) bubbles are visible under the membrane; (b) significant deposits of dried electrolyte are visible on the membrane; and (c) if the sensor shows unstable readings or other sensor-related symptoms.

During membrane changes, examine the gold cathode at the tip of the sensor and the silver anode along the shaft of the sensor. If either the silver anode is black in color or the gold cathode is dull, the sensor may need resurfaced using the fine sanding disks included in the membrane kit. Do not sand the electrode every membrane change as this is not routine maintenance. In fact, visually, the anode may appear tarnished and operate just fine. YSI recommends using the 400 grit wet/dry sanding disks to resurface the electrodes if the sensor has difficulty stabilizing or calibrating after a membrane change.

To resurface the sensor using the fine sanding disk, follow the instructions below.

#### **Gold Cathode:**

For correct sensor operation, the gold cathode must be textured properly. It can become tarnished or plated with silver after extended use. Never use chemicals or abrasives not recommended or supplied by YSI.

First dry the sensor tip completely with lens cleaning tissue. Wet a sanding disk with a small amount of clean water and place it face up in the palm of your hand. Next, with your free hand, hold the sensor in a vertical position, tip down. Place the sensor tip directly down on the sanding disk and twist it in a circular motion to sand the gold cathode. The goal is to sand off any build-up and to lightly scratch the cathode to provide a larger surface area for the O<sub>2</sub> solution under the membrane. Usually, 3 to 4 twists of the sanding disk are sufficient to remove deposits and for the gold to appear to have a matte finish. Rinse thoroughly and wipe the gold cathode with a wet paper towel before putting on a new membrane

cap. If the cathode remains tarnished, contact YSI Technical Support or the Authorized dealer where you purchased the instrument.

### **Silver Anode**

After extended use, a thick layer of Silver Chloride (AgCl) builds up on the silver anode reducing the sensitivity of the sensor. The anode must be cleaned to remove this layer and restore proper performance. The cleaning can be chemical or mechanical:

Chemical cleaning: Remove the membrane cap and rinse the electrodes with deionized or distilled water. Soak the sensing anode section of the sensor in a 14% ammonium hydroxide solution for 2 to 3 minutes or in a 3% ammonia solution overnight for 8-12 hours (most household ammonia cleaners are typically around 3%). Rinse heavily in cool tap water followed by a thorough rinsing with distilled or deionized water. The anode should then be thoroughly wiped with a wet paper towel to remove the residual layer from the anode. You can smell the tip of the sensor to help ensure all the ammonia has been rinsed off. Trapping residual ammonia under the new membrane cap can quickly tarnish the electrode and/or give false readings.



*Chemical cleaning should be performed as infrequently as possible. First attempt a membrane change and recalibrate. If a new membrane does not resolve the problem, then proceed with cleaning.*

Mechanical cleaning: In order to sand the silver anode along the shaft of the sensor, simply hold the sensor in a vertical position. Wet the sanding disk with a small amount of clean water then gently wrap it around the sensor shaft and twist it a few times to lightly sand the anode (the goal is to simply sand off any build-up without scratching or removing layers of the anode itself). Usually, 3 to 4 twists of the sanding disk are sufficient to remove deposits. However, in extreme cases, more sanding may be required to regenerate the original silver surface.

After completing the sanding procedure, repeatedly rinse the electrode with clean water and wipe with lens cleaning tissue to remove any grit left by the sanding disk. Thoroughly rinse the entire tip of the sensor with distilled or deionized water and install a new membrane.



**IMPORTANT:** Be sure to: (1) Use only the fine sanding disks provided and (2) Sand as mentioned in the above procedures. Not adhering to either of these instructions can damage the electrodes. If this procedure is unsuccessful, as indicated by improper electrode performance, contact YSI Technical Support or the Authorized dealer where you purchased the instrument.

---

### Galvanic Sensors – Model # 605202

---

We recommend that the Sodium Chloride (NaCl) solution and the membrane cap be changed at least once every 60 days during regular use. In addition, the NaCl solution and membrane should be changed if (a) bubbles are visible under the membrane; (b) significant deposits of dried electrolyte are visible around the membrane; and (c) if the sensor shows unstable readings or other sensor-related symptoms.

The Galvanic dissolved oxygen sensor is continuously reducing oxygen even when the display of the instrument is not active. This factor allows the sensor to be used with no warm-up period as soon as the instrument is powered on (instant on DO). However, because the sensor is “on” all the time, some solid from the oxidation of the zinc anode will form in the electrolyte within 1-2 weeks of activation. Small amounts of the solid will generally cause no performance problems, but excessive amounts may result in jumpy dissolved oxygen readings. The rate of solid formation is dependent on the type of membrane installed. The formation of solids based on membrane type typically form more rapidly with the 5912 (1 mil Teflon), less rapid with 5913 (1.25 mil PE), and least rapid with 5914 (2 mil PE).



*The Galvanic DO sensor solution will appear milky white after use but will NOT affect the accuracy of the sensor unless there is excessive build up. The color change is acceptable and normal as long as DO readings remain stable.*

At the time the membrane cap is changed, YSI recommends that you rinse the anode (silver shaft of the sensor) with purified water and wipe with a clean paper towel. If white deposits are evident on the anode after cleaning, YSI recommends that you remove this material by sanding the anode with the sandpaper disk enclosed in your membrane kit. Follow the “Mechanical Cleaning” instructions under the Polarographic Silver Anode section.



**IMPORTANT:** Be sure to: (1) Use only the fine sanding disks provided and (2) Sand as mentioned in the above procedures. Not adhering to either of these instructions can damage the electrodes.  
**WARNING:** DO NOT PERFORM THE POLAROGRAPHIC CHEMICAL CLEANING ON A GALVANIC SENSOR. If this procedure is unsuccessful, as indicated by improper electrode performance, contact YSI Technical Support or the Authorized dealer where you purchased the instrument.

---

## SENSOR MAINTENANCE - CONDUCTIVITY

---

The openings that allow sample access to the conductivity electrodes should be cleaned regularly. The small cleaning brush included in the Maintenance Kit is ideal for this purpose. Dip the brush in clean water and insert it into each hole 10 to 12 times. In the event that deposits have formed on the electrodes, it may be necessary to use a mild detergent (laboratory grade soap or bathroom foaming tile cleaner) with the brush. Rinse thoroughly with clean water, then check the response and accuracy of the conductivity cell with a calibration standard.



*If this procedure is unsuccessful, as indicated by improper electrode performance, contact YSI Technical Support or the Authorized dealer where you purchased the instrument.*

---

## SENSOR MAINTENANCE - TEMPERATURE

---

You must keep the temperature portion of the sensor free of build up. Other than that, the sensor requires no maintenance. The conductivity cleaning brush can be used to scrub the temperature sensor if needed. Alternatively, you can use a toothbrush to clean the sensor.

---

## SENSOR MAINTENANCE - pH, ORP AND COMBINATION pH/ORP

---



*Typical working life for pH and ORP sensors is approximately 12-24 months depending on usage, storage, and maintenance. Proper storage and maintenance generally extends the sensor's working life.*

Cleaning is required whenever deposits or contaminants appear on the glass and/or platinum surfaces or when the sensor's response slows. The cleaning can be chemical and/or mechanical.

Removing the sensor from the cable may make cleaning easier. Initially, use clean water and a soft clean cloth, lens cleaning tissue, or cotton swab to remove all foreign material from the glass bulb and/or platinum button. Then use a moistened cotton swab to carefully remove any material that may be blocking the reference electrode junction of the sensor.



**CAUTION:** *When using a cotton swab, be careful NOT to wedge the swab between the guard and the glass sensor. If necessary, remove cotton from the swab tip, so that the cotton can reach all parts of the sensor tip without stress. You can also use a pipe cleaner for this operation if more convenient.*

If good pH and/or ORP response is not restored, perform the following additional procedure:

1. Soak the sensor for 10-15 minutes in clean water containing a few drops of commercial dishwashing liquid.
2. GENTLY clean the glass bulb and platinum button by rubbing with a cotton swab soaked in the cleaning solution.
3. Rinse the sensor in clean water, wipe with a cotton swab saturated with clean water, and then rerinse with clean water.

If good pH and/or ORP response is still not restored, perform the following additional procedure:

1. Soak the sensor for 30-60 minutes in one molar (1 M) hydrochloric acid (HCl). This reagent can be purchased from most lab supply distributors. Be sure to follow the safety instructions included with the acid.
2. Rinse the sensor in clean water, wipe with a cotton swab saturated with clean water (not DI water), and then rerinse with clean water. To be certain that all traces of the acid are removed from the sensor crevices, soak the sensor in clean water for about an hour with occasional stirring.

If biological contamination of the reference junction is suspected or if good response is not restored by the above procedures, perform the following additional cleaning step:

1. Soak the sensor for approximately 1 hour in a 1:1 dilution of commercially-available chlorine bleach.
2. Rinse the sensor with clean water and then soak for at least 1 hour in clean water with occasional stirring to remove residual bleach from the junction. (If possible, soak the sensor for a period of time longer than 1 hour in order to be certain that all traces of chlorine bleach are removed.) Then rerinse the sensor with clean water and retest.



*Dry the port and sensor connector with compressed air and apply a very thin coat of o-ring lubricant to all o-rings before reinstallation.*

---

## SENSOR MAINTENANCE - CHLORIDE

---



*Typical working life for chloride sensors is approximately 3-6 months depending on usage, storage, and maintenance. Proper storage and maintenance generally extends the sensor's working life.*

The chloride sensor is considered a pellet membrane ISE. As always, when handling sensors, care should be taken to avoid damaging the membrane. This

sensor can be regenerated by washing with alcohol and/or gently polishing with fine emery paper in a circular motion to remove any deposits or discoloration, then thoroughly washing with deionized water to remove any debris. The sensor may require soaking in the high standard chloride calibration solution to recover its performance.

---

## SENSOR MAINTENANCE - AMMONIUM AND NITRATE

---



*Typical working life for ammonium and nitrate sensors is approximately 3-6 months depending on usage, storage and maintenance. Proper storage and maintenance generally extends the sensor's working life.*

The ammonium and nitrate sensors are PVC membranes. As always, when handling a sensor, care should be taken to avoid damaging the membrane. After extensive use the membranes may become coated with a deposit or scoured with fine scratches which may cause a slow or reduced response (low slope) or unstable readings. Deposits may be removed with a fine jet of deionized water or rinsing in alcohol followed by soaking in the high standard calibration solution. Gently dab dry with a lint-free tissue before taking measurements.

---

## SENSOR STORAGE

---

---

### SHORT-TERM STORAGE

---

The cable assembly is supplied with a sensor storage container, or sleeve, that attaches to the cable. The container is used for short-term storage (less than 30 days). Be sure to keep a small amount of moisture (tap water) in the container during storage. This is done to maintain a 100% saturated air environment which is ideal for short-term sensor storage. The sensors should not be submersed in water. The intent is to create a humid air storage environment.

---

### LONG-TERM STORAGE

---

---

#### Long-term Storage - Temperature

---

No special storage is required. The temperature sensor can be stored dry or wet as long as solutions in contact with the thermistor are not corrosive (for example, chlorine bleach).

*Long-term Storage Temperature: -5 to 70°C (23 to 158°F)*

---

### Long-term Storage - Conductivity

---

No special storage is required. Sensors can be stored dry or wet as long as solutions in contact with conductivity electrodes are not corrosive (for example, chlorine bleach). However, it is recommended that the sensor be cleaned with the provided brush prior to and after long term storage.

*Long-term Storage Temperature: -5 to 70°C (23 to 158°F)*

---

### Long-term Storage - Dissolved Oxygen

---

Dissolved oxygen sensors (Polarographic and Galvanic) should be stored in a dry state for long term storage. First, remove the membrane cap and thoroughly rinse the sensor with clean water. Next, either blow it dry with compressed air or allow to air dry completely. Install a clean, dry new membrane cap over the sensor to keep it dry and to protect the electrodes.

After storing the sensor for a long period of time, it is necessary to “condition” the sensor by putting a new membrane with electrolyte solution on the sensor and then turning the instrument on to allow the sensor sufficient time to stabilize.

*Long-term Storage Temperature: -5 to 70°C (23 to 158°F)*

---

### Long-term Storage - pH

---

The key to pH sensor storage, short or long-term, is to make certain that the sensor does not dry out. Sensors which have been allowed to dry out due to improper storage procedures may be irreparably damaged by the dehydration and will require replacement. You can try to rehydrate the sensor by soaking it (preferably overnight) in a potassium chloride solution or a pH 4 buffer before attempting to calibrate.

To store the sensor, remove it from the cable and seal the vacant port with a port plug. Fill the original shipping/storage vessel (plastic boot or bottle) with buffer 4 solution and then submerge the sensor into the solution. The sensor should remain submerged in the solution during the storage period; therefore, make certain that the vessel is sealed to prevent evaporation and periodically check the vessel to ensure the sensor does not dry out.

*Long-term Storage Temperature: 0 to 30°C (32 to 86°F)*



*It is important not to store the pH sensor in distilled or deionized water as the glass sensor may be damaged by exposure to this medium.*

---

## Long-term Storage - ORP

---

To store, remove the sensor from the cable and seal the vacant port with the provided plug. Fill the original shipping/storage vessel (plastic boot or bottle) with buffer 4 solution and then submerge the sensor into the solution. The sensor should remain submerged in the solution during the storage period; therefore, make certain that the vessel is sealed to prevent evaporation and periodically check the vessel to ensure the sensor does not dry out.

*Long-term Storage Temperature: 0 to 30°C (32 to 86°F)*

---

## Long-term Storage - Ammonium, Nitrate, and Chloride

---

The key to ISE sensor storage, short or long-term, is to make certain that the sensor does not dry out. Sensor junctions that have been allowed to dry out due to improper storage procedures may be irreparably damaged by the dehydration and will require replacement. You can attempt to rehydrate the sensor by soaking it (preferably overnight) in the sensor's high calibration solution before attempting to calibrate.

The recommended storage of these sensors is in moist air. Remove the sensor from the cable and seal the vacant port with the provided plug. Place the sensor in its original shipping storage vessel (plastic boot or bottle) with a small amount of tap water or its high calibration standard. The vessel should remain a saturated air environment. The sensor only needs to be kept in moist air, not submerged. Make certain that the vessel is sealed to prevent evaporation.

*Long-term Storage Temperature: 0 to 30°C (32 to 86°F)*

---

## TROUBLESHOOTING

---


**Illegal Value** may appear during alpha/numeric entry on the message line. This only appears if the values entered do not match the formatting. This will also appear in GLP security area if the password is incorrect.

If you forget the GLP Security Password please contact YSI Tech Support at [environmental@ysi.com](mailto:environmental@ysi.com), 800-897-4151, or +1 937 767-7241.

---

## HELP

---

During use of the Professional Plus instrument, press **Question**  from any screen to view help messages directly on the display.

---

## ERROR MESSAGES

---

If readings for a certain parameter are over range you will see a series of +++++ and if the readings are under range you will see a series of ----- plus the error message along the bottom of the screen. If you see a series of ????? that will indicate that a certain parameter can not be calculated. The following are potential error messages:

Probe Temp over range  
Probe Temp under range  
Case Temp over range  
Case Temp under range  
pH over range  
pH under range  
ORP over range  
ORP under range  
Cl over range  
Cl under range  
NH4 over range  
NH4 under range  
NO3 over range  
NO3 under range  
DO over range  
DO under range  
Conductivity over range  
Conductivity under range  
Barometer over range  
Barometer under range

Error messages for the sensors typically indicate a need to properly clean the sensor. First verify the sensor is properly setup in the Sensor menu, then conduct the recommended cleaning and attempt to calibrate the sensor. If this does not work, it may indicate the useful life of the sensor has been reached and may need to be replaced. You may also contact Technical Support to help determine the next step.

## DISSOLVED OXYGEN

The dissolved oxygen sensors will use Probe Current (DO uA) and Probe Slope (%/uA) as part of their GLP file records. The following information indicates the acceptable values for each of these readings:

Polarographic DO at 25 °C, 100% saturated air environment at 760 mmHg

### Probe Current

1.25 mil PE membrane

Average 6.15 uA (min. 4.31 uA, max. 8.00 uA)

2.0 mil PE membrane

Average 3.38 uA (min. 2.37 uA, max. 4.40 uA)

1 mil Teflon® membrane

Average 16.29 uA (min. 11.40 uA, max. 21.18 uA)

### Probe Slope

1.25 mil PE membrane

Average 16.26 % sat/uA (min. 12.51 uA, max. 23.23 uA)


2.0 mil PE membrane

Average 29.56 % sat/uA (min. 22.74 uA, max. 42.23 uA)

1 mil Teflon® membrane

Average 6.14 % sat/uA (min. 4.72 uA, max. 8.77 uA)

## RESTORE DEFAULT CALIBRATION VALUES

Occasionally, the instrument may need to have the factory calibration default values restored. In order to accomplish this press Calibrate , highlight **Restore Default Cal** and press enter. Highlight the parameter you wish to restore to default and press enter. Next you will be asked to confirm the operation. Highlight **Yes** and press enter to confirm.



## ACCESSORIES / PART NUMBERS

<i>Cable Part Number*</i>	<i>Description</i>
6050000	Professional Plus Instrument
60510-1, -4, -10, -20, or -30	1, 4, 10, 20, or 30-meter cable for ISE/temp
60520-1, -4, -10, -20, or -30**	1, 4, 10, 20, or 30-meter cable for DO/temp
60530-1, 4, -10, -20, or -30	1, 4, 10, 20 or 30-meter cable for Cond/temp
6051010-1, 4, -10, -20, or -30	1, 4, 10, 20, or 30-meter cable for ISE/ISE/temp
6051020-1, -4, -10, -20, or -30	1, 4, 10, 20, or 30-meter cable for ISE/DO/temp
6051030-1, 4, -10, -20, or -30	1, 4, 10, 20, or 30-meter cable for ISE/Cond/temp
6052030-1, -4, -10, -20, or -30	1, 4, 10, 20 or 30-meter cable for DO/Cond/temp
605790-1, -4, -10, -20, or -30	1, 4, 10, 20 or 30-meter Quatro cable for DO/Cond/temp/ISE/ISE
605107	1-meter pH/temp single junction lab-grade combo electrode
605177	4-meter pH/temp single junction lab-grade combo electrode
605108	1-meter ORP/temp single junction lab-grade combo electrode
605178	4-meter ORP/temp single junction lab-grade combo electrode
605109	1-meter pH/ORP/temp single junction lab-grade combo electrode
605179	4-meter pH/ORP/temp single junction lab-grade combo electrode






<i>Sensor Part Number</i>	<i>Description</i>
605202	Galvanic DO sensor
605203	Polarographic DO sensor
605101	pH (ISE)
605102	ORP (ISE)
605103***	pH/ORP Combination (ISE)
605104****	Ammonium (ISE)

<i>Sensor Part Number</i>	<i>Description</i>
605105****	Chloride (ISE)
605106****	Nitrate (ISE)
605780	Self-Stirring BOD sensor
005560	Conductivity/Temperature sensor for Quatro cable

- \* All cables include temperature.  
Cables with conductivity include sensor  
(no need to order separate conductivity sensor).
- \*\* Special order cables up to 100-meters are available with 60520 cables.
- \*\*\* Not compatible with 6051010-X or Quatro cables.
- \*\*\*\* Freshwater only

<i>Accessory Part Number</i>	<i>Description</i>
603059	Flow cell, standard, 203 mL (for two-port sensors) 
603077	Flow cell kit, 1 or 2 port sensor (includes 603059 flow cell for two-port sensors with the 603078 adapter for one-port sensors) 
603078	Flow cell adapter, single port (use with 603059 flow cell to accommodate one-port sensors)

<i>Accessory Part Number</i>	<i>Description</i>
605990	Flow cell kit for Quatro cable assemblies.
603056	Flow cell mounting spike 
605604	Communications saddle kit 
605515	Data Manager desktop software
603075	Carrying case, soft-sided 
603074	Carrying case, hard-sided 
605745	Maintenance kit
038213	Brush, tube cleaner
601205	Grease, o-ring

<i>Accessory Part Number</i>	<i>Description</i>
603069	Belt clip 
063517	Ultra clamp 
063507	Tripod clamp 
603062	Cable management kit 
605978	Weight, sensor/cable, 4.9 oz. 
063019	Weight, sensor/cable, 24 oz., 3"
063020	Weight, sensor/cable, 51 oz., 6"
603070	Shoulder strap

<i>Solutions Part Number</i>	<i>Description</i>
3161	1,000 us/cm conductivity solution (quart)
3163	10,000 us/cm conductivity solution (quart)
3169	50,000 us/cm conductivity solution (8 pints)
3682	Zobell ORP solution (125 mL)
3824	pH 4, 7, 10 buffers (2 pints of each)
3841	1 mg/L ammonium solution (500 mL)
3842	10 mg/L ammonium solution (500 mL)
3843	100 mg/L ammonium solution (500 mL)
3885	1 mg/L nitrate solution (500 mL)
3886	10 mg/L nitrate solution (500 mL)
3887	100 mg/L nitrate solution (500 mL)
5580	Confidence Solution (verifies pH, ORP, conductivity sensor performance)

## DECLARATION OF CONFORMITY

The undersigned hereby declares on behalf of the named manufacturer under our sole responsibility that the listed product conforms to the requirements for the listed European Council Directive(s) and carries the CE mark accordingly.

<i>Manufacturer:</i>	YSI Incorporated 1725 Brannum Lane Yellow Springs, OH 45387 USA
<i>Product Name:</i>	Professional Plus Water Quality Instrument
<i>Model Numbers</i>	
<i>Instrument/Accessory:</i>	Professional Plus (6050000) / ProComm (605604)
<i>Probe/Cable Assemblies:</i>	605107, 605177, 605108, 605178, 605109, 605179, 605780, 60510, 60520, 60530, 6051010, 6051020, 6051030, 6052030, 605790
<i>Sensors:</i>	605202, 605203, 605780, 605101, 605102, 605103, 605104, 605105, 605106, 005560
<i>Conforms to the following:</i>	
<i>Directives:</i>	EMC 2004/108/EC RoHS 2002/95/EC WEEE 2002/96/EC



<i>Harmonized Standards:</i>	<ul style="list-style-type: none"> <li>• EN61326-1:2006, Electrical equipment for measurement, control, and laboratory use – EMC requirements – Part 1: General Requirements</li> <li>• EN61326-2-3:2006, Electrical equipment for measurement, control and laboratory use – EMC requirements – Part 2-3: Particular Requirements – Test configuration, operational conditions, and performance criteria for transducers with integrated or remote signal conditioning.</li> <li>• EN61000-3-2:2006, Electromagnetic compatibility (EMC) – Part 3-2: Limits – Limits for harmonic current emissions (equipment input current &lt; 16A per phase).</li> <li>• EN61000-3-3:1995 +A1:2001 +A2:2005, Electromagnetic compatibility (EMC) – Part 3: Limits – Section 3: Limitation of voltage fluctuations and flicker in low-voltage supply systems for equipment with rated current &lt; 16A.</li> </ul>
Supplementary Information:	<p>All performance met the continuous unmonitored operation criteria as follows:</p> <ol style="list-style-type: none"> <li>1. ESD, EN61000-4-2, Performance Criterion B</li> <li>2. Radiated Immunity, EN61000-4-3, Performance Criterion A</li> <li>3. EFT, EN61000-4-4, (EFT) Performance Criterion B</li> <li>4. Surge, EN61000-4-5, Performance Criterion B</li> <li>5. Conducted Immunity, EN61000-4-6, Performance Criterion A</li> <li>6. Voltage Interrupts, EN61000-4-11, Performance Criterion B</li> <li>7. RF Emissions, EN55011:1998, A1:1999 Class B equipment</li> </ol>
Authorized EU Representative	YSI Hydrodata Ltd Unit 8, Business Centre West, Avenue 1 Letchworth, Hertfordshire, SG6 2HB UK



Signed: Lisa M. Abel  
Title: Director of Quality

Date: 22 February 2008

The undersigned hereby declares on behalf of the named manufacturer under our sole responsibility that the listed product conforms to the requirements for electrical equipment under US FCC Part 15 and ICES-003 for unintentional radiators.

<i>Manufacturer:</i>	YSI Incorporated 1725 Brannum Lane Yellow Springs, OH 45387 USA
<i>Product Name:</i>	
<i>Model Numbers</i>	
<i>Instrument/Accessory:</i>	Professional Plus (6050000) / ProComm (605604)
<i>Probe/Cable Assemblies:</i>	605107, 605177, 605108, 605178, 605109, 605179, 605780, 60510, 60520, 60530, 6051010, 6051020, 6051030, 6052030, 605790
<i>Sensors:</i>	605202, 605203, 605780, 605101, 605102, 605103, 605104, 605105, 605106, 005560
<i>Conforms to the following:</i>	
<i>Standards:</i>	<ul style="list-style-type: none"> <li>• FCC 47 CFR Part 15-2008, Subpart B, Class B, Radio Frequency Devices</li> <li>• ICES-003:2004, Digital Apparatus</li> </ul>
<i>Supplementary Information:</i>	Tested using ANSI C63.4-2003 (excluding sections 4.1, 5.2, 5.7, 9, and 14)



Signed: Lisa M. Abel  
Title: Director of Quality

Date: 22 February 2008

The undersigned hereby declares on behalf of the named manufacturer under our sole responsibility that the listed product conforms with the Australian and New Zealand Electromagnetic Compatibility (EMC) requirements for generic products to be used in residential, commercial, and light industrial environments.

<i>Manufacturer:</i>	YSI Incorporated 1725 Brannum Lane Yellow Springs, OH 45387 USA
<i>Product Name:</i>	Professional Plus Water Quality Instrument
<i>Model Numbers</i>	
<i>Instrument/Accessory:</i>	Professional Plus (6050000) / ProComm (605604)
<i>Probe/Cable Assemblies:</i>	605107, 605177, 605108, 605178, 605109, 605179, 605780, 60510, 60520, 60530, 6051010, 6051020, 6051030, 6052030, 605790
<i>Sensors:</i>	605202, 605203, 605780, 605101, 605102, 605103, 605104, 605105, 605106, 005560
<i>Conforms to the following:</i>	
<i>Standards:</i>	• AS/NZS 4251.1:1999, Electromagnetic Compatibility (EMC) – Generic emission standard – Part 1: Residential, commercial, and light industry.



Signed: Lisa M. Abel  
Title: Director of Quality

Date: 22 February 2008

## RECYCLING

YSI is committed to reducing the environmental footprint in the course of doing business. Even though materials reduction is the ultimate goal, we know there must be a concerted effort to responsibly deal with materials after they've served a long, productive life-cycle. YSI's recycling program ensures that old equipment is processed in an environmentally friendly way, reducing the amount of materials going to landfills.

- Printed Circuit Boards are sent to facilities that process and reclaim as much material for recycling as possible.
- Plastics enter a material recycling process and are not incinerated or sent to landfills.

- Batteries are removed and sent to battery recyclers for dedicated metals. When the time comes for you to recycle, follow the easy steps outlined at [www.ysi.com](http://www.ysi.com).

## CONTACT INFORMATION

### ORDERING AND TECHNICAL SUPPORT

Telephone: 800 897 4151 (US)  
+1 937 767 7241 (Globally)  
Monday through Friday, 8:00 AM to 5:00 ET

Fax: +1 937 767 9353 (orders)  
+1 937 767 1058 (technical support)

Email: [environmental@ysi.com](mailto:environmental@ysi.com) or [proseries@ysi.com](mailto:proseries@ysi.com)

Mail: YSI Incorporated  
1725 Brannum Lane  
Yellow Springs, OH 45387 USA

Internet: [www.ysi.com](http://www.ysi.com)

When placing an order please have the following available:

- 1.) YSI account number (if available)
- 2.) Name and phone number
- 3.) Purchase Order or Credit Card
- 4.) Model Number or brief description
- 5.) Billing and shipping addresses
- 6.) Quantity Telephone: 800 897 4151 (US)

### SERVICE INFORMATION

YSI has authorized service centers throughout the United States and Internationally. For the nearest service center information, please visit [www.ysi.com](http://www.ysi.com) and click 'Support' or contact YSI Technical Support directly at 800-897-4151.

When returning a product for service, include the Product Return form with cleaning certification. The form must be completely filled out for a YSI Service Center to accept the instrument for service. The form may be downloaded from [www.ysi.com](http://www.ysi.com) by clicking on the 'Support' tab, then the Product Return Form button.

Item # 605596  
Rev D  
Drawing # A605596  
March 2009

©2009 YSI Incorporated.



# Professional *Plus*



## Calibration Tips

# Table of Contents

---

Introduction.....	1
Calibration Worksheet .....	1
Temperature .....	3
Calibration Tips .....	3
Troubleshooting Tips.....	3
Conductivity .....	4
Calibration Tips .....	4
Troubleshooting Tips.....	4
pH.....	6
Calibration Tips .....	6
Troubleshooting Tips.....	6
ORP.....	9
Calibration Tips .....	9
Troubleshooting Tips.....	9
Dissolved Oxygen.....	11
Calibration Tips .....	11
Troubleshooting Tips.....	12
Ammonium .....	15
Calibration Tips .....	15
Troubleshooting Tips.....	16
Nitrate .....	18
Calibration Tips .....	18
Troubleshooting Tips .....	19
Chloride .....	21
Calibration Tips .....	21
Troubleshooting Tips.....	22
Installing and Uninstalling Sensors .....	24
General Precautions .....	24
Uninstalling DO, pH, ORP, pH/ORP and ISE Sensors.....	25
Installing DO, pH, ORP, pH/ORP and ISE Sensors .....	25
Uninstalling a Conductivity/Temperature Sensor in a Quatro Cable .....	25
Installing a Conductivity/Temperature Sensor in a Quatro Cable.....	25
Cleaning a Sensor Port.....	26
Verifying Sensor Accuracy and Calibration.....	26
Resetting a Sensor to Factory Default.....	26

## **Introduction**

---

This guide provides helpful instructions, tips and troubleshooting suggestions for calibrating a Professional Plus instrument. For more detailed information on calibration and information on how to setup and operate a Pro Plus, please refer to the Pro Plus User Manual.

## **Calibration Worksheet**

---

The Calibration Worksheet on the following page is provided for your convenience. Utilizing the Calibration Worksheet can help document your calibration and track the performance of your sensors.

Date of Calibration: \_\_\_\_\_ Technician: \_\_\_\_\_

Instrument Serial Number: \_\_\_\_\_ Software Revision: \_\_\_\_\_ Cable Model Number: \_\_\_\_\_

Temperature Reading \_\_\_\_\_ Temperature Accurate: Y N

DO Sensor in use: Polarographic Galvanic Sensor notated in Sensor menu? Y N

DO membrane changed? Y N Color of Membrane \_\_\_\_\_ Color notated in Sensor menu? Y N

Record the following calibration values:

	Pre Cal	After Cal	
Conductivity	_____	_____	
ORP	_____	_____	
DO	_____	_____	True Barometric Pressure at time of calibration _____

	Pre Cal		
pH 7	_____	pH mV value _____	Range 0 mV $\pm$ 50 mV
pH 4	_____	pH mV value _____	Range +165 to +180 from 7 buffer mV value
pH 10	_____	pH mV value _____	Range -165 to -180 from 7 buffer mV value

NOTE: See pH Cal tips section for additional information. Span between pH 4 and 7 and 7 and 10 mV values should be  $\approx$  165 to 180 mV. 177 is the ideal distance or 59 mV per pH unit.

**Ammonium**

1<sup>st</sup> point (1 mg/L) \_\_\_\_\_ NH4 mV value \_\_\_\_\_ Range: 0 mV +/- 20 mV (new sensor only)

2<sup>nd</sup> point (100 mg/L) \_\_\_\_\_ NH4 mV value \_\_\_\_\_ Range: 90 to 130 mV > 1 mg/L mV value

**Nitrate**

1<sup>st</sup> point (1 mg/L) \_\_\_\_\_ NO3 mV value \_\_\_\_\_ Range: 200 mV +/- 20 mV (new sensor only)

2<sup>nd</sup> point (100 mg/L) \_\_\_\_\_ NO3 mV value \_\_\_\_\_ Range: 90 to 130 mV < 1 mg/L mV value

**Chloride**

1<sup>st</sup> point (10 mg/L) \_\_\_\_\_ Cl mV value \_\_\_\_\_ Range: 225 mV +/- 20 mV (new sensor only)

2<sup>nd</sup> point (1000mg/L) \_\_\_\_\_ Cl mV value \_\_\_\_\_ Range: 80 to 130 < 10 mg/L mV value

Record the following diagnostic numbers **after** calibration, by viewing the .glp file and reading the values for the day's calibration

Conductivity Cal Cell Constant \_\_\_\_\_ Range 5.0 +/- 1.0 acceptable

DO Sensor Value (uA) \_\_\_\_\_ (Membrane dependent, see DO Cal Tips)

pH Slope \_\_\_\_\_ ( $\approx$  55 to 60 mV/pH, 59 ideal)

pH Slope % of ideal \_\_\_\_\_

# Temperature

---

## **CALIBRATION TIPS**

Before calibrating any other Pro Plus sensor, verify that the temperature sensor is reading accurately by comparing it to a traceable thermometer or other known reference in a water bath. Temperature compensation is used in every other sensor measurement so its accuracy should be verified and recorded each time the Pro Plus is calibrated. Be sure to consider the specification tolerances of both the Pro Plus temperature sensor and the thermometer when comparing the measurements.

The Pro Plus temperature sensor can not be calibrated nor should calibration be required.

## **TROUBLESHOOTING TIPS**

If the temperature sensor is not reading accurately, ensure that it is clean and free of debris. The conductivity cleaning brush and warm water with mild detergent can be used to scrub the temperature sensor if needed. Alternatively, you can use a toothbrush to clean the sensor.

### **Quatro Cables**

Quatro cables have a replaceable combination conductivity/temperature sensor (p/n 005560). All other Pro Plus cables have integral temperature sensors. If using a Quatro cable and your temperature sensor is not reading accurately, remove the conductivity/temperature sensor from the cable. The Pro Plus should read ----- °C without a temperature sensor installed. If the instrument is reading any other value, the conductivity/temperature port on the cable may be contaminated. Refer to the Cleaning the Sensor Port section of this document for information on how to clean the port.

After cleaning the port, recheck the temperature reading. If the temperature reading is still not displaying ----- °C without the sensor installed, there may be a problem with the cable and/or instrument. In this case, contact your local YSI Representative or a YSI Authorized Service Center.

### **Other Pro Plus Cables**

If your temperature sensor is not reading accurately after cleaning around the sensor, contact your local YSI Representative or an YSI Authorized Service Center.



# Conductivity

---

The conductivity calibration should be verified every day the instrument is used. However, the conductivity sensor is very stable and may hold its calibration for several weeks.

## CALIBRATION TIPS

1. It is not necessary to calibrate conductivity, specific conductance and salinity. Calibrating one of these parameters will simultaneously calibrate the others. YSI recommends calibrating specific conductance (temperature compensated conductivity) for greatest ease and accuracy.
2. Ensure the conductivity sensor is clean and dry before performing a specific conductance calibration.
3. Always use fresh, traceable conductivity calibration solution when calibrating the conductivity sensor.
  - a. The shelf life of conductivity solution is one month after being opened. This is due to potential changes in the value of the solution caused by evaporation which can occur after opening the bottle. Be sure to write the open date on the bottle so you know that you are using good calibration solution.
  - b. Never calibrate with a conductivity solution that is less than 1.0 mS/cm. You are setting the slope on a linear device so a good strong conductivity signal will give you the best performance. Use 1.0 mS/cm for fresh water, 10 mS/cm for brackish to estuarine water and 50 mS/cm for salt water. 1.0 mS (millisiemens) = 1000 uS (microsiemens).
4. Pre-rinse the cal cup and sensors with a small amount of calibration standard or rinse standard and discard.
5. When calibrating the conductivity sensor, the calibration solution must cover the top vent holes of the conductivity sensor. If using a Quatro cable, the top vent hole is located on the side of the combination conductivity/temperature sensor. If using a different cable, the conductivity sensor is integral to the cable and the sensor has two vent holes located close to the cable. Ensure the entire conductivity sensor is submerged in the solution or the instrument will read approximately half the expected value.
6. After placing the sensor into the solution, gently move the sensor up and down to remove any air bubbles that may be trapped in the conductivity sensor.
7. If calibrating Specific Conductance, enter the value of the conductivity solution as it is listed for 25°C. Make sure you are entering the correct units. 1 mS = 1,000 uS.
8. If you receive a warning message stating that the calibration is questionable, do not continue with the calibration. Instead, select 'No' and investigate what is causing the questionable results. If you accept a questionable calibration, your conductivity readings (and your DO mg/L readings) will be erroneous. Typical causes for this error message include: incorrect entries (entering 1000 uS/cm instead of 1.0 mS/cm), not using enough solution to cover the vent holes, air bubbles trapped in the sensor, calibrating in conductivity instead of specific conductance, dirty conductivity electrodes, and/or bad calibration solution.
9. After accepting a good calibration, navigate to the GLP file and check the conductivity cell constant for the calibration. For highest accuracy, the cell constant should be 5.0 +/- 0.5. However, the acceptable range is 5 +/- 1.0. A cell constant outside of this range indicates that a questionable calibration was accepted.

## TROUBLESHOOTING TIPS

If you get an error message during calibration, be sure that you are:

1. Entering the correct calibration value (1 mS/cm = 1000 uS/cm).
2. Calibrating in Specific Conductance mode.
3. Using enough solution to cover the vent holes on the sensor.
4. Dislodging any air bubbles that could be trapped in the sensor.
5. Using a fresh, traceable conductivity calibration solution.

If you are following the above recommendations and still receiving an error message, check the conductivity sensor to make sure it is clean. A clean conductivity sensor should read less than 3 uS/cm in dry air. If your sensor is dry and giving you a reading higher than 3 uS/cm in air, it should be cleaned.

The conductivity calibration generates its cell constant value after calibration. The ideal cell constant is 5.0 +/-0.5 but 5.0 +/- 1.0 is acceptable. Any significant jump or change in this number from one calibration to the next usually indicates a problem with the calibration and/or sensor. If you are sure that your calibration standard is good and your calibration process is correct, then your sensor may need to be cleaned.

### **Cleaning the Conductivity Sensor**

The openings that allow sample access to the conductivity electrodes should be cleaned regularly. The small cleaning brush included in the Maintenance Kit is intended for this purpose. Dip the brush in clean water and insert it into each hole 10 to 12 times. In the event that deposits have formed on the electrodes, it may be necessary to use a mild detergent (laboratory grade soap or bathroom foaming tile cleaner) with the brush. Rinse thoroughly with clean water, then check the response and accuracy of the conductivity sensor with calibration solution.

### **Quatro Cables**

Quatro cables have a replaceable combination conductivity/temperature sensor (p/n 5560). All other Pro Plus cables have integral conductivity sensors. If using a Quatro cable and your conductivity sensor is not calibrating or is reading > 3 uS/cm in dry air after being cleaned, remove the conductivity/temperature sensor from the cable. The Pro Plus should read < 3 uS/cm for conductivity (not specific conductance) without a conductivity sensor installed. If the instrument is reading > 3 uS/cm without a sensor installed, the conductivity/temperature port on the cable may be contaminated. Refer to the Cleaning the Sensor Port section of this document for information on how to clean the port.

If the conductivity measurement continues to read more than 3 uS/cm without a conductivity/temperature sensor installed, there may be a problem with the cable and/or instrument. In this case, contact your local YSI Representative or a YSI Authorized Service Center.

### **Other Pro Plus Cables**


If your conductivity sensor is not calibrating or is reading > 3 uS/cm in dry air after performing a sensor cleaning, contact your local YSI Representative or a YSI Authorized Service Center.

# pH

---

The pH calibration should be verified every day the instrument is used. However, a new pH sensor may be capable of holding its calibration for several days.

## CALIBRATION TIPS

1. If using a pH sensor in a 6051010 or Quatro cable, calibrate the sensor in port 1 prior to calibrating the sensor in port 2. The sensor in port 2 uses the reference of the sensor installed in port 1. Therefore, it is important to verify that the port 1 sensor is working properly before calibrating the port 2 sensor. See pH Troubleshooting Tips for additional info.
2. The pH sensor can be calibrated with up to six calibration points.
3. Calibration can be accomplished in any buffer order.
4. pH 7 buffer should be used regardless of how many calibration points you use; however, it does not have to be the first point.
5. In most cases, a two-point calibration is all that is required (4 and 7 or 7 and 10). You can bracket the expected in-situ pH values. Use a three-point calibration with 4, 7 and 10 if the in-situ pH values are unknown or if you expect the in-situ values to be on both sides of the pH scale.
6. Rinse the sensors and cal cup with a small amount of pH buffer. Fill the cup so that the pH sensor tip and the temperature sensor are submerged in buffer.
7. If necessary, highlight the Calibration Value and enter the pH value of the buffer solution. Note: The Pro Plus has auto buffer recognition which can be set to USA (4, 7, 10) or NIST (4.01, 6.86, 9.18) buffer values in the pH Sensor Setup menu.
8. Record the pH millivolts for each calibration point. The acceptable mV outputs for each buffer are shown below.
  - pH 7 mV value = 0 mV +/- 50 mV
  - pH 4 mV value = +165 to +180 from 7 buffer mV value
  - pH 10 mV value = -165 to -180 from 7 buffer mV value
  - A value of +50 or -50 mVs in buffer 7 does not indicate a bad sensor.
  - The mV span between pH 4 and 7 and 7 and 10 mV values should be  $\approx$  165 to 180 mV. 177 is the ideal distance. The slope can be 55 to 60 mV per pH unit with an ideal of 59 mV per pH unit.
  - If the mV span between pH 4 and 7 or 7 and 10 drops below 160, clean the sensor and try to recalibrate.
9. Wait for the pH to stabilize in the each buffer and then press enter to accept each calibration point.
10. Rinse the sensor and cal cup with a small amount of the next buffer between calibration points.
11. After pressing enter to accept your last calibration point, press cal  to complete the calibration. Otherwise you will continue calibrating up to 6 calibration points.
12. If you receive a warning message stating that the calibration is questionable, do not continue with the calibration. Instead, select 'No' and investigate what is causing the questionable results. If you accept a questionable calibration, your pH readings will be erroneous. Typical causes for this error message include: incorrect Sensor/Port setup in the instrument, a dirty sensor or bad buffer solution.
13. After accepting a good calibration, navigate to the GLP file and check the pH Slope and Slope % of ideal. A good slope should be between 55 and 60 mVs while the ideal is 59 mV. If the slope drops below 53, the sensor should be reconditioned and recalibrated.

## TROUBLESHOOTING TIPS

Typical working life for pH sensors is approximately 12-24 months depending on usage, storage and maintenance. Proper storage and maintenance generally extends the sensor's working life.

Clean and recondition the sensor if a slow response in the field has been reported or if it takes more than 90 seconds to stabilize in pH buffer.

If you get an error message during a pH calibration, check the following:

1. Ensure the pH buffers are good and not expired
2. Ensure that the pH sensor is installed in the correct port of the cable and the correct ISE is enabled in the Sensor Setup menu.
  - a. If using a pH or pH/ORP combo sensor in a 6051020 cable, ensure the sensor is installed in port 1.
  - b. If using a pH or pH/ORP combo sensor in a 60510, 6051020 or 6051030 cable, pH should be enabled in ISE1 of the instrument's Sensor Setup menu.
  - c. If using a pH sensor in a 6051010 or Quatro cable, check to see if the pH sensor is installed in port 1 or port 2. If the pH sensor is installed in port 1, enable pH in ISE1 of the Sensor Setup menu. If the pH sensor is installed in port 2, enable pH in ISE2 of the Sensor Setup menu. Note: It is not recommended to use a pH/ORP combo sensor in 6051010 or Quatro cables. If using a pH/ORP combo sensor in a 6051010 or Quatro cable, ORP will not be measured or reported.
3. If using a 6051010 or Quatro cable, you must have a sensor installed in port 1 for port 2 to operate. Additionally, ensure that the sensor installed in port 1 is in good working order. In 6051010 and Quatro cables, the sensors installed in port 1 and port 2 use the reference from the sensor installed in port 1 only. Therefore, if the sensor installed in port 1 is not working properly, the readings from the sensor installed in port 2 will be erroneous. For greatest ease, install a pH sensor in port 1 of both 6051010 and Quatro cables and your other ISE sensor in port 2.
4. If you continue to get error messages during calibration, clean and recondition the sensor.

### **Cleaning and Reconditioning the pH, ORP or pH/ORP Sensor**

If the pH or pH/ORP sensor has been allowed to dry out or has been stored in distilled or deionized water for an extended period of time, soak the sensor in buffer 4 overnight to try and restore functionality.

Cleaning is required whenever deposits or contaminants appear on the glass and/or platinum surfaces or when the sensor's response slows. The cleaning can be chemical and/or mechanical.

Removing the sensor from the cable may make cleaning easier. Initially, moisten a soft clean cloth, lens cleaning tissue or cotton swab to remove all foreign material from the glass bulb and/or platinum button. Then use a moistened cotton swab to carefully remove any material that may be blocking the reference electrode junction of the sensor. **CAUTION:** When using a cotton swab, be careful NOT to wedge the swab between the guard and the glass sensor. If necessary, remove cotton from the swab tip, so that the cotton can reach all parts of the sensor tip without stress. You can also use a pipe cleaner for this cleaning if more convenient.

If good pH and/or ORP response is not restored, perform the following additional procedure:

1. Soak the sensor for 10-15 minutes in clean water containing a few drops of commercial dishwashing liquid.
2. GENTLY clean the glass bulb and platinum button by rubbing with a cotton swab soaked in the cleaning solution.
3. Rinse the sensor in clean water, wipe with a cotton swab moistened with clean water, and then re-rinse with clean water.

If good pH and/or ORP response is still not restored, perform the following additional procedure:

1. Soak the sensor for 30-60 minutes in one molar (1 M) hydrochloric acid (HCl). This reagent can be purchased from most lab supply distributors. Be sure to follow the safety instructions included with the acid.

2. Rinse the sensor in clean water, wipe with a cotton swab moistened with clean water (not DI water), and then re-rinse with clean water. To be certain that all traces of the acid are removed from the sensor crevices, soak the sensor in clean tap water for about an hour with occasional stirring.

If biological contamination of the reference junction is suspected or if good response is not restored by the above procedures, perform the following additional cleaning step:

**CAUTION:** Do not mix the acid from the previous step with the chlorine bleach in the following step. A toxic gaseous product can form from the reaction between the acid and the chlorine bleach. Be certain to copiously rinse the sink and drain system of acid after its disposal and before the disposal of chlorine bleach.

1. Soak the sensor for approximately 1 hour in a 1:1 dilution of commercially available chlorine bleach.
2. Rinse the sensor with clean water and then soak for at least 1 hour in clean tap water with occasional stirring to remove residual bleach from the junction. (If possible, soak the sensor for a period of time longer than 1 hour in order to be certain that all traces of chlorine bleach are removed.) Then re-rinse the sensor with clean water and retest.

Prior to reinstalling the sensor, dry the port and sensor connector with compressed air. If you suspect port contamination, follow the instructions in the Cleaning a Sensor Port section of this document before reinstalling the sensor.

If your pH sensor is still not calibrating after performing a sensor cleaning, contact your local YSI Representative or a YSI Authorized Service Center.

# ORP

---

The ORP calibration should be verified every day the instrument is used. However, a new ORP sensor may be capable of holding its calibration for several days.

## CALIBRATION TIPS

1. If using a pH/ORP combination sensor, calibrate pH first to ensure it is working.
2. If using an ORP sensor in a 6051010 or Quatro cable, calibrate the sensor in port 1 prior to calibrating the sensor in port 2. The sensor in port 2 uses the reference of the sensor installed in port 1. Therefore, it is important to verify that the port 1 sensor is working properly before calibrating the port 2 sensor. See ORP Troubleshooting Tips for additional info.
3. Rinse the sensors and cal cup with a small amount of ORP calibration solution. Fill the cup so that the ORP sensor tip and the temperature sensor are submerged in solution.
4. Enter the calibration value per the temperature reading. The value of ORP calibration solution is greatly affected by temperature. The ORP solution should include a chart of solution values per temperature. If not, contact the supplier of the ORP solution to obtain this information. The Pro Series ORP sensors use a Ag/AgCl 3.5 M KCl reference. Be sure the value you enter is for this type of reference. If using the YSI Zobell calibration solution, the Pro Plus will automatically determine the calibration value.
5. Wait for the readings to stabilize and then press enter to accept the calibration.
6. If you receive a warning message stating that the calibration is questionable, do not continue with the calibration. Instead, select 'No' and investigate what is causing the questionable results. If you accept a questionable calibration, your ORP readings will be erroneous. Typical causes for this error message include: incorrect Sensor/Port setup in the instrument, a dirty sensor or bad calibration solution.

## TROUBLESHOOTING TIPS

Typical working life for ORP sensors is approximately 12-24 months depending on usage, storage and maintenance. Proper storage and maintenance generally extends the sensor's working life.

Clean and recondition the sensor if the sensor exhibits a slow response in Zobell solution, i.e. it takes more than 90 seconds to stabilize when placed in Zobell.

If you get error messages during an ORP calibration, check the following:

1. Ensure the ORP calibration solution is good and not expired.
2. Ensure that the ORP sensor is installed in the correct port of the cable and the correct ISE is enabled in the Sensor Setup menu.
  - a. If using an ORP or pH/ORP combo sensor in a 6051020 cable, ensure the sensor is installed in port 1.
  - b. If using an ORP sensor in a 60510, 6051020 or 6051030 cable, ORP should be enabled in ISE1 of the instrument's Sensor Setup menu.
  - c. If using a pH/ORP combo sensor in a 60510, 6051020 or 6051030 cable, ORP should be enabled in ISE2 of the instrument's Sensor Setup menu.
  - d. If using an ORP sensor in a 6051010 or Quatro cable, check to see if the ORP sensor is installed in port 1 or port 2. If the ORP sensor is installed in port 1, enable ORP in ISE1 of the Sensor Setup menu. If the ORP sensor is installed in port 2, enable ORP in ISE2 of the Sensor Setup menu.
5. If using a pH/ORP combo sensor in a 6051010 or Quatro cable, ORP will not be measured or reported.
6. If using a 6051010 or Quatro cable, you must have a sensor installed in port 1 for port 2 to operate. Additionally, ensure that the sensor installed in port 1 is calibrated and in good working order. In 6051010 and Quatro cables, the sensors installed in port 1 and port 2 use the reference from the sensor installed in

port 1 only. Therefore, if the sensor installed in port 1 is not working properly, the readings from the sensor installed in port 2 will be erroneous.

7. If you continue to get error messages during calibration, clean and recondition the sensor per the instructions in the pH Troubleshooting section of this document. If you suspect port contamination, follow the instructions in the Cleaning a Sensor Port section before reinstalling the sensor.
8. If you continue to have problems, you can check the offset of the ORP sensor by performing a factory reset to the ORP sensor. After resetting the sensor, compare the ORP mV readings in Zobell solution to the calibration value. The difference between values should be less than 100 mVs. If the difference is 80 mVs or higher, consider replacing the sensor as it is nearing the end of its life span.

# Dissolved Oxygen

---

The dissolved oxygen sensor should be calibrated every day the instrument is used. It is not necessary to calibrate in both % and mg/L or ppm. Calibrating in % will simultaneously calibrate mg/L and ppm and vice versa.

## CALIBRATION TIPS

1. The Pro Plus can be calibrated in air-saturated water, water-saturated air or against a Winkler Titration. You can perform a 1 or 2 point DO calibration. A 2 point calibration includes 1 point in a zero oxygen environment and the 2<sup>nd</sup> point at full saturation.
2. For both ease of use and accuracy, YSI recommends that you perform a 1 point calibration in water-saturated air.
3. Make sure that there is a good membrane with fresh electrolyte (O<sub>2</sub> probe solution) installed on the DO sensor. The membrane should be clean and free of wrinkles. There should not be any air bubbles present under the membrane. Membranes should be changed regularly and generally last 2-8 weeks depending on use and storage.
4. To perform a 1 point calibration in water-saturated air, place the sensor in a 100% humid environment. This can be accomplished several ways:
  - a. For the 60520 and 6052030 cables, moisten the sponge in the gray calibration sleeve with a *small* amount of clean water and place it over the sensor guard.
  - b. For the 6051020 and Quatro cables, place a small amount of water in the calibration/storage cup and place it over the sensors. When screwing the calibration cup onto the sensor bulkhead, only engage one or two threads. Do not screw the calibration cup completely onto the sensor bulkhead. The goal is to have air exchange between inside and outside the calibration cup.

The sponge and calibration sleeve/cup should be clean since bacterial growth may consume oxygen and interfere with the calibration. Be sure the sensor is in air, not water, and that there are not any water droplets on the membrane or temperature sensor.

5. After entering the % calibration mode, wait approximately 5 to 15 minutes for the storage container to become completely saturated and, if using a polarographic sensor, to allow the sensor to stabilize.
6. Salinity affects the ability of water to hold oxygen and is used by the instrument to calculate DO mg/L (ppm). The Salinity value displayed near the top of the DO calibration screen is either the salinity correction value entered in the Sensor menu or the Salinity value as measured by the conductivity sensor in use. If you are using a conductivity sensor, ensure that it is calibrated and reading correctly in order to obtain accurate DO mg/L (ppm) measurements. If you are not using a conductivity sensor, the Salinity correction value should be the salinity of the water you will be testing. Highlight Salinity and press enter to modify this setting if necessary. The salinity of fresh water is typically 0-0.5 ppt and seawater is typically 35 ppt.
7. After accepting the calibration, navigate to the GLP menu and record the DO sensor's value (sensor current in uA). The acceptable sensor currents when calibration is performed at 25°C, in a 100% saturated air environment at 760 mmHg are:
  - 1.25 mil PE membrane (yellow membrane): Average 6.15 uA (min. 4.31 uA, max. 8.00 uA)
  - 2.0 mil PE membrane (blue membrane): Average 3.38 uA (min. 2.37 uA, max. 4.40 uA)
  - 1 mil Teflon membrane: Average 16.29 uA (min. 11.40 uA, max. 21.18 uA)
8. If you receive a warning message stating that the calibration is questionable, do not continue with the calibration. Instead, select 'No' and investigate what is causing the questionable results. If you accept a questionable calibration, your DO readings will be erroneous. Typical causes of a calibration error message include: incorrect sensor, membrane or port setup in the instrument, incorrect barometric pressure information, a bad membrane or a sensor that needs reconditioned.

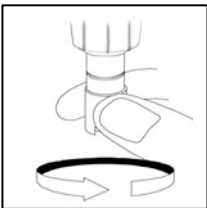


## TROUBLESHOOTING TIPS

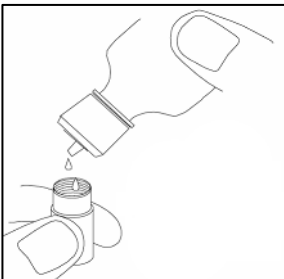
1. Ensure that the correct sensor type and membrane type are enabled in the Sensor Setup Menu. Galvanic sensors have a gray probe body and Polarographic sensors have a black probe body.
2. If using a 6051020 cable, ensure that the DO sensor is installed in port 2. If using a Quatro cable, ensure that the DO sensor is installed in the port labeled DO.
3. Ensure the Pro Plus barometer is reading accurately. The DO % Saturation calibration uses the instrument's barometric pressure reading for the DO % calibration. If the barometer is not reading accurately, the calibration will be erroneous. The barometer should be reading *true* barometric pressure. If you suspect the barometer reading is incorrect, calibrate the barometer and then recalibrate the DO sensor. Laboratory barometer readings are usually "true" (uncorrected) values of air pressure and can be used "as is" for barometer calibration. Weather service readings are usually not "true", i.e., they are corrected to sea level, and therefore cannot be used until they are "uncorrected". An approximate formula for this "uncorrection" is:  
True BP in mmHg = Corrected BP in mmHg – [2.5 \* (Local Altitude in ft. above sea level/100)]
4. Install a new membrane with fresh electrolyte onto the DO sensor. Ensure you are using the correct electrolyte solution. Polarographic sensors use electrolyte that is in a white labeled bottle (KCl/Na<sub>2</sub>SO<sub>4</sub>). Galvanic sensors use electrolyte that is in a blue labeled bottle (NaCl).
5. Recondition the DO sensor and then install a new membrane.
6. If you suspect port contamination, remove the sensor and follow the instructions in the Cleaning a Sensor Port section.
7. If you continue to have trouble calibrating the DO sensor, contact your local YSI Representative or a YSI Authorized Service Center.

## Membrane Cap Installation

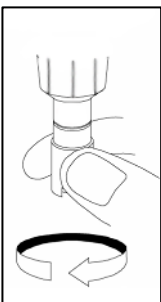
The DO membrane and electrolyte solution (O<sub>2</sub> solution) should be changed once every 2-8 weeks depending on use and storage. In addition, the membrane and electrolyte solution should be changed if (a) bubbles are visible under the membrane; (b) significant deposits of dried electrolyte are visible on the membrane; or (c) if the sensor shows unstable readings or other sensor-related symptoms. To install a new membrane cap follow these instructions:



1. Remove the sensor guard or cal cup to access the sensor tip.
2. Unscrew and remove any old membrane cap by holding the sensor when unscrewing the membrane cap. Discard the used membrane cap.
3. Thoroughly rinse the sensor tip with distilled or DI water.

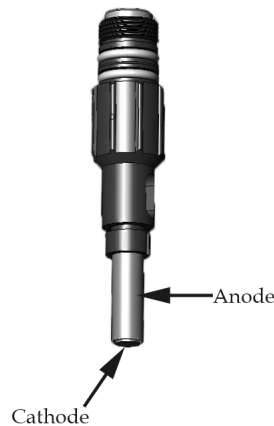


4. Fill a new membrane cap with the appropriate electrolyte solution that has been prepared according to the directions on the bottle. Polarographic sensors use electrolyte that is in a white labeled bottle (KCl/Na<sub>2</sub>SO<sub>4</sub>). Galvanic sensors use electrolyte that is in a blue labeled bottle (NaCl). Be very careful not to touch the membrane surface during this process. Lightly tap the side of the membrane cap to release air bubbles that may be trapped.



5. Thread the membrane cap onto the sensor. It is normal for a small amount of electrolyte to overflow.

## Reconditioning the DO Sensor



### **Polarographic Sensors - Model # 605203**

Due to the chemical reaction taking place under the membrane, deposits will form on the gold cathode and silver anode. The gold cathode will begin to appear dull and the silver anode will turn dark in color. This discoloration is normal; however, it is recommended that you remove the deposits as needed. Perform the following cleaning procedures to remove the deposits if 1.) You have troubles calibrating the sensor or the DO readings are unstable; and 2.) Changing a membrane does not correct the problem.

#### **Silver Anode:**

After extended use, a layer of Silver Chloride ( $\text{AgCl}$ ) builds up on the silver anode reducing the sensitivity of the sensor. The anode must be cleaned to remove this layer and restore proper performance. The cleaning can be chemical and/or mechanical:

Chemical cleaning: Remove the membrane cap and rinse the electrodes with deionized or distilled water. Soak the sensing electrode section of the sensor in a 14% ammonium hydroxide solution for 2 to 3 minutes or in a 3% ammonia solution overnight for 8-12 hours (most household ammonia cleaners are typically around 3%). Rinse heavily in cool tap water followed by a thorough rinsing with distilled or deionized water. The anode should then be thoroughly wiped with a wet paper towel to remove the residual layer from the anode. Trapping residual ammonia under the new membrane cap can quickly tarnish the electrode and/or give false readings.

Note: Chemical cleaning should be performed as infrequently as possible (1 or 2 times per year depending on use). First attempt a membrane change and recalibrate. If a new membrane does not resolve the problem, then proceed with cleaning.

After performing a chemical cleaning, perform a mechanical cleaning on both the anode and cathode.

Mechanical cleaning: In order to sand the silver anode along the shaft of the sensor, remove the membrane and hold the sensor in a vertical position. Wet 400 grit wet/dry sand paper with a small amount of clean water then gently wrap it around the sensor anode and twist it a few times to lightly sand the anode (the goal is to sand off any build-up without scratching or removing layers of the anode itself). Usually, 3 to 4 twists of the sanding disk are sufficient to remove deposits. However, in extreme cases, more sanding may be required to remove all of the deposits.

After completing the sanding procedure, repeatedly rinse the electrode with clean water and wipe with lens cleaning tissue to remove any grit left by the sanding disk. Thoroughly rinse the entire tip of the sensor with distilled or deionized water and install a new membrane.

### **Gold Cathode:**

For correct sensor operation, the gold cathode must be textured properly. It can become tarnished or plated with silver after extended use. Never use chemicals or abrasives not recommended or supplied by YSI.

First dry the sensor tip completely with lens cleaning tissue. Wet 400 grit wet/dry sand paper with a small amount of clean water and place it face up in the palm of your hand. Next, with your free hand, hold the sensor in a vertical position, tip down. Place the sensor tip directly down on the sanding disk and twist it in a circular motion to sand the gold cathode. The goal is to sand off any build-up and to lightly scratch the cathode to provide a larger surface area for the electrolyte solution under the membrane. Usually, 3 to 4 twists of the sanding disk are sufficient to remove deposits and for the gold to appear to have a matte finish. Rinse thoroughly and wipe the gold cathode with a wet paper towel before putting on a new membrane cap.

Note: Be sure to: (1) Only use fine 400 grit wet/dry sand paper and (2) Sand as mentioned in the above procedures. Not adhering to either of these instructions can damage the electrodes. If this procedure is unsuccessful, as indicated by improper DO sensor performance, contact your local YSI Representative or a YSI Authorized Service Center.

### **Galvanic Sensors – Model # 605202**

The Galvanic dissolved oxygen sensor is continuously reducing oxygen even when the Pro Plus is turned off. This factor allows the sensor to be used with no warm-up time as soon as the instrument is powered on. However, because the sensor is “on” all the time, some solid from the oxidation of the zinc anode will form in the electrolyte within 1-2 weeks of activation. The Galvanic electrolyte solution will appear milky white after use but this will not affect the accuracy of the sensor unless there is excessive build up which may result in jumpy readings. Otherwise, the color change is acceptable and normal as long as DO readings remain stable. The rate of solid formation is dependent on the type of membrane installed. The formation of solids typically form more rapidly with the 5912 (black 1 mil Teflon), less rapid with 5913 (yellow 1.25 mil PE), and least rapid with 5914 (blue 2 mil PE).

When changing the membrane, rinse the anode and cathode with distilled or deionized water and wipe with a clean paper towel. If white deposits are evident on the anode after rinsing and wiping, remove the deposits by sanding the anode with 400 grit wet/dry sand paper following the “Mechanical Cleaning” instructions under the Polarographic Silver Anode maintenance section. If there are deposits on the cathode, sand the cathode with 400 grit wet/dry sand paper following the maintenance instructions listed for the Polarographic Gold Cathode.

Note: Do not perform the Polarographic chemical cleaning on a Galvanic sensor.

If this procedure is unsuccessful, as indicated by improper sensor performance, contact your local YSI Representative or a YSI Authorized Service Center.


# Ammonium

---

The ammonium sensor should be calibrated every day the instrument is used. The ammonium sensor should only be used in fresh water (salinity < 2 ppt) and to depths of 55 feet (17 meters) of water.

Ammonia is calculated from the ammonium, temperature and pH readings. pH greatly affects the ammonia calculation. Therefore, for highest accuracy in the ammonia calculation, be sure to use a pH sensor in conjunction with an ammonium sensor during measurements. If a pH sensor is not in use, the instrument will assume the sample is neutral (pH 7) for the calculation.

## CALIBRATION TIPS

1. If using an ammonium sensor with either a pH or ORP sensor on a 6051010 or Quatro cable, install the pH or ORP sensor in port 1 and the ammonium sensor in port 2.
2. If using an ammonium sensor on a 6051010 or Quatro cable, calibrate the sensor in port 1 prior to calibrating the sensor in port 2. The sensor in port 2 uses the reference of the sensor installed in port 1. Therefore, it is important to verify that the sensor in port 1 is working properly before calibrating the sensor in port 2. See ammonium Troubleshooting Tips for additional information on port configuration.
3. Exposure to the high ionic content of pH buffers can cause a significant, but temporary, drift in the ammonium sensor. Therefore, if calibrating a pH sensor, either:
  - a. Remove the ammonium sensor from the cable bulkhead and plug the port. After pH calibration is complete, reinstall the ammonium sensor and proceed with its calibration with no stabilization delay.Or,
  - b. Calibrate pH first, immersing both sensors in the pH buffers. After calibrating pH, place the sensors in 100 mg/L ammonium standard and monitor the reading. Usually, the reading starts low and may take awhile to reach a stable value. When it does, proceed with the calibration. This may take several hours.
4. The ammonium sensor can be calibrated with up to three calibration points. For highest accuracy, perform a two point calibration with 1 and 100 mg/L standards within 10°C of your sample temperature.
5. Rinse the sensors and cal cup with a small amount of ammonium solution (1 mg/L for the first point and 100 mg/L for the second point). Fill the cup so that the ammonium sensor tip and the temperature sensor are submerged in solution. If using a Quatro cable or 6051030 cable, ensure that the conductivity sensor is also submerged in the calibration solution. The salinity reading from the conductivity sensor is used in the algorithm for the ammonium measurement.
6. After entering the calibration screen, change the calibration value if necessary.
7. If not using a conductivity sensor, enter the salinity value of the calibration standard. After calibration, change the salinity correction value to the salinity value of the water you will be testing in the field in order to obtain the most accurate ammonium measurement. You can change the salinity correction value in the Sensor menu. As mentioned, the Ammonium sensor should only be used in fresh water salinity < 2 ppt). The salinity of fresh water is typically 0 to 0.5 ppt.
8. Record the NH<sub>4</sub> millivolts for each calibration point. The acceptable mV outputs for each calibration solution are shown below.
  - NH<sub>4</sub> 1 mg/L = 0 mV +/- 20 mV (new sensor only)
  - NH<sub>4</sub> 100 mg/L = 90 to 130 mV > 1 mg/L mV value
  - The mV span between 1 mg/L and 100 mg/L values should be ≈ 90 to 130 mV. The slope should be 45 to 65 mV per decade.
9. Wait for the ammonium and temperature readings to stabilize in each calibration solution and then press enter to accept each calibration point.
10. Rinse the sensor and cal cup between calibration points with a small amount of the next buffer.
11. After pressing enter to accept your last calibration point, press cal  to complete the calibration. Otherwise you will continue calibrating up to 3 calibration points.

12. If you receive a warning message stating that the calibration is questionable, do not continue with the calibration. Instead, select 'No' and investigate what is causing the questionable results. If you accept a questionable calibration, your ammonium and ammonia readings will be erroneous. Typical causes for this error message include: incorrect Sensor/Port setup in the instrument, a dirty sensor or bad buffer solution.

### **Preparing Ammonium Calibration solution**

We recommend using YSI calibration solutions whenever possible. However, qualified users can save cost by following these recipes for 1 and 100 mg/L standards. Other concentrations can be made by altering the amount of ammonium chloride. All other ingredient concentrations should remain unchanged. It is important to note that some of these chemicals are hazardous and therefore, the standards should only be prepared by qualified chemists in laboratories where proper safety precautions are possible. It is the responsibility of the user to obtain and study the MSDS for each chemical and to follow the required instructions with regard to handling and disposal of these materials.

You will need: solid Ammonium Chloride or a certified 100 mg/L  $\text{NH}_4^+$ -N from a supplier, Lithium Acetate Dihydrate, concentrated hydrochloric acid, high purity water, a good quality analytical balance, a 1000 ml volumetric flask, accurate volumetric measuring devices for 100 ml and 10 ml of solution, and a 1000 ml glass or plastic storage vessels. **(Caution: Hydrochloric acid is highly corrosive and toxic and should therefore be handled with extreme care in a well-ventilated fume hood. The user could also add the equivalent amount of a less-hazardous, more dilute sample of the acid if preferred.)**

**100 mg/L Standard:** Accurately weigh 0.3817 g of ammonium chloride and transfer quantitatively into a 1000 ml volumetric flask. Add 2.6 g of lithium acetate dihydrate to the flask. Add approximately 500 ml of distilled or deionized water to the flask, swirl to dissolve all of the reagents and then dilute to the volumetric mark with distilled or deionized water. Mix well by repeated inversion and then transfer the 100 mg/L standard to a storage bottle. Add 3 drops of concentrated hydrochloric acid to the bottle, then seal and agitate to assure homogeneity. Alternatively, 100 ml of certified 100 mg/L  $\text{NH}_4^+$ -N standard can be used in place of the solid ammonium chloride.

**1 mg/L Standard:** Accurately measure 10.0 ml of the above 100 mg/L standard solution into a 1000 ml volumetric flask. Add 2.6 g of lithium acetate dihydrate to the flask. Add approximately 500 ml of distilled or deionized water, swirl to dissolve the solid reagents and then dilute to the volumetric mark with water. Mix well by repeated inversion and then transfer the 1 mg/L standard to a storage bottle. Add 3 drops of concentrated hydrochloric acid to the bottle, then seal and agitate to assure homogeneity.

### **TROUBLESHOOTING TIPS**

Typical working life for ammonium sensors is approximately 3-6 months depending on use, storage and maintenance. Proper storage and maintenance generally extends the sensor's working life.

If you get error messages during an ammonium calibration, check the following:

1. Ensure the ammonium solutions are good and not expired
2. Ensure that the ammonium sensor is installed in the correct port of the cable and the correct ISE is enabled in the Sensor Setup menu.
  - a. If using an ammonium sensor in a 6051020 cable, ensure the sensor is installed in port 1.
  - b. If using an ammonium sensor in a 60510, 6051020 or 6051030 cable, ammonium should be enabled in ISE1 in the instrument's Sensor Setup menu.
  - c. If using an ammonium sensor in a 6051010 or Quatro cable, check to see if the ammonium sensor is installed in the port 1 or port 2. If the ammonium sensor is installed in port 1, enable ammonium in ISE1 of the Sensor Setup menu. If the ammonium sensor is installed in port 2, enable ammonium in ISE2 of the Sensor Setup menu. Note: If using with a pH or ORP sensor, it is recommended to install the pH or ORP sensor in port 1 and the ammonium sensor in port 2.

3. If using a 6051010 or Quatro cable, you must have a sensor installed in port 1 for port 2 to operate. Additionally, ensure that the sensor installed in port 1 is in good working order. In 6051010 and Quatro cables, the sensors installed in port 1 and port 2 use the reference from the sensor installed in port 1 only. Therefore, if the sensor installed in port 1 is not working properly, the readings from the sensor installed in port 2 will be erroneous as well.
4. If you continue to get error messages during calibration, clean the sensor.
5. If you continue to get error messages during calibration, soak the sensor in 100 mg/L ammonium standard for several hours or overnight.
6. If you suspect port contamination, follow the instructions in the Cleaning a Sensor Port section.
7. If you continue to have trouble calibrating the ammonium sensor, contact your local YSI Representative or a YSI Authorized Service Center.

### **Cleaning the Ammonium Sensor**

The ammonium sensor uses a PVC membrane. As always, when handling a sensor, care should be taken to avoid damaging the membrane. After extensive use, the membranes may become coated with a deposit or scoured with fine scratches which may cause a slow or reduced response (low slope) or unstable readings. Deposits may be removed with a fine jet of deionized water or rinsing in alcohol followed by soaking in 100 mg/L ammonium calibration standard.


The sensor may require soaking in the high ammonium calibration solution to recover its performance. Soak in 100 mg/L for several hours or overnight.

# Nitrate

---

The nitrate sensor should be calibrated every day the instrument is used. The nitrate sensor should only be used in fresh water (salinity < 2 ppt) and to depths of 55 feet (17 meters) of water.

## CALIBRATION TIPS

1. If using a nitrate sensor with either a pH or ORP sensor on a 6051010 or Quatro cable, install the pH or ORP sensor in port 1 and the nitrate sensor in port 2.
2. If using a nitrate sensor on a 6051010 or Quatro cable, calibrate the sensor in port 1 prior to calibrating the sensor in port 2. The sensor in port 2 uses the reference of the sensor installed in port 1. Therefore, it is important to verify that the sensor in port 1 is working properly before calibrating the sensor in port 2. See nitrate Troubleshooting Tips for additional information on port configuration.
3. Exposure to the high ionic content of pH buffers can cause a significant, but temporary, drift in the nitrate sensor. Therefore, if calibrating a pH sensor, either:
  - a. Remove the nitrate sensor from the cable bulkhead and plug the port. After pH calibration is complete, reinstall the nitrate sensor and proceed with its calibration with no stabilization delay.Or
  - b. Calibrate pH first, immersing both sensors in the pH buffers. After calibrating pH, place the sensors in 100 mg/L nitrate standard and monitor the reading. Usually, the reading starts low and may take awhile to reach a stable value. When it does, proceed with the calibration. This may take several hours.
4. The nitrate sensor can be calibrated with up to three calibration points. For highest accuracy, perform a two point calibration with 1 and 100 mg/L standards within 10°C of your sample temperature.
5. Rinse the sensors and cal cup with a small amount of nitrate solution (1 mg/L for the first point and 100 mg/L for the second point). Fill the cup so that the nitrate sensor tip and the temperature sensor are submerged in solution. If using a Quatro cable or 6051030 cable, ensure that the conductivity sensor is also submerged in the calibration solution. The salinity reading from the conductivity sensor is used in the algorithm for the nitrate measurement.
6. After entering the calibration screen, change the calibration value if necessary.
7. If not using a conductivity sensor, enter the salinity value of the calibration standard. After calibration, change the salinity correction value to the salinity value of the water you will be testing in the field in order to obtain the most accurate nitrate measurement. You can change the salinity correction value in the Sensor menu. As mentioned, the nitrate sensor should only be used in fresh water (salinity < 2 ppt). The salinity of fresh water is typically 0 to 0.5 ppt.
8. Record the NO<sub>3</sub> millivolts for each calibration point. The acceptable mV outputs for each calibration solution are shown below.
  - NO<sub>3</sub> 1 mg/L = 200 mV +/- 20 mV (new sensor only)
  - NO<sub>3</sub> 100 mg/L = 90 to 130 mV < 1 mg/L mV value
  - The mV span between 1 mg/L and 100 mg/L values should be ≈ 90 to 130 mV. The slope should be -45 to -65 mV per decade.
9. Wait for the nitrate and temperature readings to stabilize in each calibration solution and then press enter to accept each calibration point.
10. Rinse the sensor and cal cup between calibration points with a small amount of the next buffer.
11. After pressing enter to accept your last calibration point, press cal  to complete the calibration. Otherwise you will continue calibrating up to 3 calibration points.
12. If you receive a warning message stating that the calibration is questionable, do not continue with the calibration. Instead, select 'No' and investigate what is causing the questionable results. If you accept a questionable calibration, your nitrate readings will be erroneous. Typical causes for this error message include: incorrect Sensor/Port setup in the instrument, a dirty sensor or bad buffer solution.

## Preparing Nitrate Calibration Solution

We recommend using YSI calibration solutions whenever possible. However, qualified users can save cost by following these recipes for 1 and 100 mg/L nitrate standards. Other concentrations can be made by altering the amount of potassium nitrate. All other concentrations should remain unchanged. It is important to note that some of these chemicals are hazardous and therefore, the standards should only be prepared by qualified chemists in laboratories where proper safety precautions are possible. It is the responsibility of the user to obtain and study the MSDS for each chemical and to follow the required instructions with regard to handling and disposal of these materials.

You will need: Solid Potassium Nitrate or a certified 1000 mg/l  $\text{NO}_3^-$ -N from a supplier, Magnesium Sulfate, high purity water, good quality analytical balance, 1000 ml volumetric flask, accurate volumetric measuring devices for 100 ml, 10 ml and 1 ml of solution, and 1000 ml glass or plastic storage vessels.

**100 mg/L standard:** Accurately weigh 0.7222 g of anhydrous potassium nitrate and transfer quantitatively into a 1000 ml volumetric flask. Add 1.0 g of anhydrous magnesium sulfate to the flask. Add approximately 500 ml of water to the flask, swirl to dissolve all of the reagents, and then dilute to the volumetric mark with distilled or deionized water. Mix well by repeated inversion and then transfer the 100 mg/L standard to a storage bottle. Rinse the flask extensively with water prior to its use in the preparation of the 1 mg/l standard. Alternatively, 100 mL of certified 1000 mg/L  $\text{NO}_3^-$ -N standard can be used in place of the solid potassium nitrate.

**1 mg/L standard:** Accurately measure 10.0 mL of the above 100 mg/L standard solution into a 1000 mL volumetric flask. Add 1.0 g of anhydrous magnesium sulfate to the flask. Add approximately 500 mL of distilled or deionized water, swirl to dissolve the solid reagents, and then dilute to the volumetric mark with water. Mix well by repeated inversion and then transfer the 1 mg/L standard to a storage bottle.

Recipes are given for 1 and 100 mg/L. Other concentrations can be made by altering the amount of potassium nitrate. All other concentrations should remain unchanged.

## TROUBLESHOOTING TIPS

Typical working life for nitrate sensors is approximately 3-6 months depending on use, storage and maintenance. Proper storage and maintenance generally extends the sensor's working life.

If you get error messages during a nitrate calibration, check the following:

1. Ensure the nitrate solutions are good and not expired
2. Ensure that the nitrate sensor is installed in the correct port of the cable and the correct ISE is enabled in the Sensor Setup menu.
  - a. If using a nitrate sensor in a 6051020 cable, ensure the sensor is installed in port 1.
  - b. If using a nitrate sensor in a 60510, 6051020 or 6051030 cable, nitrate should be enabled in ISE1 of the instrument's Sensor Setup menu.
  - c. If using a nitrate sensor in a 6051010 or Quatro cable, check to see if the nitrate sensor is installed in port 1 or port 2. If the nitrate sensor is installed in port 1, enable nitrate in ISE1 of the Sensor Setup menu. If the nitrate sensor is installed in port 2, enable nitrate in ISE2 of the Sensor Setup menu.  
Note: If using with a pH or ORP sensor, it is recommended to install the pH or ORP sensor in port 1 and the nitrate sensor in port 2.
3. If using a 6051010 or Quatro cable, you must have a sensor installed in port 1 for port 2 to operate. Additionally, ensure that the sensor installed in port 1 is in good working order. In 6051010 and Quatro cables, the sensors installed in port 1 and port 2 use the reference from the sensor installed in port 1 only. Therefore, if the sensor installed in port 1 is not working properly, the readings from the sensor installed in port 2 will be erroneous as well.



4. If you continue to get error messages during calibration, clean the sensor.
5. If you continue to get error messages during calibration, soak the sensor in 100 mg/L nitrate standard for several hours or overnight.
6. If you suspect port contamination, follow the instructions in the Cleaning a Sensor Port section.
7. If you continue to have trouble calibrating the nitrate sensor, contact your local YSI Representative or a YSI Authorized Service Center.

### **Cleaning and Reconditioning the Nitrate Sensor**

The nitrate sensor uses a PVC membrane. As always, when handling a sensor, care should be taken to avoid damaging the membrane. After extensive use the membranes may become coated with a deposit or scoured with fine scratches which may cause a slow or reduced response (low slope) or unstable readings. Deposits may be removed with a fine jet of deionized water or rinsing in alcohol followed by soaking in 100 mg/L nitrate calibration standard.


The sensor may require soaking in the high nitrate calibration solution to recover its performance. Soak in 100 mg/L for several hours or overnight.

# Chloride

---

The chloride sensor should be calibrated every day the instrument is used. The chloride sensor should only be used in fresh water (salinity < 2 ppt) and to depths of 55 feet (17 meters) of water.

## CALIBRATION TIPS

1. If using a chloride sensor with either a pH or ORP sensor on a 6051010 or Quatro cable, install the pH or ORP sensor in port 1 and the chloride sensor in port 2.
2. If using a chloride sensor on a 6051010 or Quatro cable, calibrate the sensor in port 1 prior to calibrating the sensor in port 2. The sensor in port 2 uses the reference of the sensor installed in port 1. Therefore, it is important to verify that the sensor in port 1 is working properly before calibrating the sensor in port 2. See Chloride Troubleshooting Tips for additional information on port configuration.
3. Exposure to the high ionic content of pH buffers can cause a significant, but temporary, drift in the chloride sensor. Therefore, if calibrating a pH sensor, either:
  - c. Remove the chloride sensor from the cable bulkhead and plug the port. After pH calibration is complete, reinstall the chloride sensor and proceed with its calibration with no stabilization delay.
  - Or,
  - d. Calibrate pH first, immersing both sensors in the pH buffers. After calibrating pH, place the sensors in 1,000 mg/L chloride standard and monitor the reading. Usually, the reading starts low and may take awhile to reach a stable value. When it does, proceed with the calibration. This may take several hours.
4. The chloride sensor can be calibrated with up to three calibration points. For highest accuracy, perform a two point calibration with 10 and 1000 mg/L standards within 10°C of your sample temperature.
5. Rinse the sensors and cal cup with a small amount of chloride solution (10 mg/L for the first point and 1,000 mg/L for the second point). Fill the cup so that the chloride sensor tip and the temperature sensor are submerged in solution. If using a Quatro cable or 6051030 cable, ensure that the conductivity sensor is also submerged in the calibration solution. The salinity reading from the conductivity sensor is used in the algorithm for the chloride measurement.
6. After entering the calibration screen, change the calibration value if necessary.
7. If not using a conductivity sensor, enter the salinity value of the calibration standard. After calibration, change the salinity correction value to the salinity value of the water you will be testing in the field in order to obtain the most accurate chloride measurement. You can change the salinity correction value in the Sensor menu. As mentioned, the chloride sensor should only be used in fresh water (salinity < 2 ppt). The salinity of fresh water is typically 0 to 0.5 ppt.
8. Record the Cl millivolts for each calibration point. The acceptable mV outputs for each calibration solution are shown below.
  - Cl 10 mg/L = 225 mV +/- 20 mV (new sensor only)
  - Cl 1,000 mg/L = 80 to 130 mV < 10 mg/L mV value
  - The mV span between 10 mg/L and 1000 mg/L values should be  $\approx$  80 to 130 mV. The slope should be -40 to -65 mV per decade.
9. Wait for the chloride and temperature readings to stabilize in each calibration solution and then press enter to accept each calibration point.
10. Rinse the sensor and cal cup between calibration points with a small amount of the next buffer.
11. After pressing enter to accept your last calibration point, press cal  to complete the calibration. Otherwise you will continue calibrating up to 3 calibration points.
12. If you receive a warning message stating that the calibration is questionable, do not continue with the calibration. Instead, select 'No' and investigate what is causing the questionable results. If you accept a questionable calibration, your chloride readings will be erroneous. Typical causes for this error message include: incorrect Sensor/Port setup in the instrument, a dirty sensor or bad buffer solution.

## Preparing Chloride Calibration Solution

The following recipes are provided for preparation of 10 and 1000 mg/L chloride reagents.

It is important to note that some of the chemicals required for these solutions could be hazardous under some conditions. It is the responsibility of the user to obtain and study the MSDS for each chemical and to follow the required instructions with regard to handling and disposal of these chemicals.

You will need: Solid sodium chloride or a certified 1000 mg/L chloride solution from a supplier, magnesium sulfate, high purity water, a good quality analytical balance, 1000 ml volumetric flask, an accurate 10 ml measuring devices, and 1000 ml glass or plastic storage vessels.

**1000 mg/L standard:** Accurately weigh 1.655 grams of anhydrous sodium chloride and transfer into a 1000 ml volumetric flask. Add 0.5 grams of anhydrous magnesium sulfate to the flask. Add 500 ml of distilled or deionized water to the flask, swirl to dissolve all of the reagents, and then dilute to the volumetric mark with water. Mix well by repeated inversion and then transfer the 1000 mg/L standard to a storage bottle. Rinse the flask extensively with water prior to its use in the preparation of the 10 mg/L standard. Alternatively, simply add 0.5 grams of magnesium sulfate to a liter of a 1000 mg/L chloride standard from a certified supplier.

**10 mg/L standard:** Accurately measure 10 ml of the above 1000 mg/L standard solution into a 1000 ml volumetric flask. Add 0.5 grams of anhydrous magnesium sulfate to the flask. Add 500 ml of distilled or deionized water, swirl to dissolve the solid reagents, and then dilute to the volumetric mark with water. Mix well by repeated inversion and then transfer the 10 mg/L standard to a storage bottle.

## TROUBLESHOOTING TIPS

Typical working life for chloride sensors is approximately 3-6 months depending on use, storage and maintenance. Proper storage and maintenance generally extends the sensor's working life.

If you get error messages during a chloride calibration, check the following:

1. Ensure the chloride solutions are good and not expired
2. Ensure that the chloride sensor is installed in the correct port of the cable and the correct ISE is enabled in the Sensor Setup menu.
  - a. If using a chloride sensor in a 6051020 cable, ensure the sensor is installed in port 1.
  - b. If using a chloride sensor in a 60510, 6051020 or 6051030 cable, chloride should be enabled in ISE1 of the instrument's Sensor Setup menu.
  - c. If using a chloride sensor in a 6051010 or Quatro cable, check to see if the chloride sensor is installed in port 1 or port 2. If the chloride sensor is installed in port 1, enable chloride in ISE1 of the Sensor Setup menu. If the chloride sensor is installed in port 2, enable chloride in ISE2 of the Sensor Setup menu. Note: If using with a pH or ORP sensor, it is recommended to install the pH or ORP sensor in port 1 and the chloride sensor in port 2.
3. If using a 6051010 or Quatro cable, you must have a sensor installed in port 1 for port 2 to operate. Additionally, ensure that the sensor installed in port 1 is in good working order. In 6051010 and Quatro cables, the sensors installed in port 1 and port 2 use the reference from the sensor installed in port 1 only. Therefore, if the sensor installed in port 1 is not working properly, the readings from the sensor installed in port 2 will be erroneous as well.
4. If you continue to get error messages during calibration, clean the sensor.
5. If you continue to get error messages during calibration, soak the sensor in 1000 mg/L chloride standard for several hours or overnight.
6. If you suspect port contamination, follow the instructions in the Cleaning a Sensor Port section.
7. If you continue to have trouble calibrating the chloride sensor, contact your local YSI Representative or a YSI Authorized Service Center.

## **Cleaning and Reconditioning the Chloride Sensor**

The chloride sensor is considered a pellet membrane ISE. As always, when handling sensors, care should be taken to avoid damaging the membrane. This sensor can be regenerated by washing with alcohol and/or gently polishing with fine emery paper in a circular motion to remove any deposits or discoloration, then thoroughly washing with deionized water to remove any debris.

The sensor may require soaking in the high chloride calibration solution to recover its performance. Soak in 1000 mg/L for several hours or overnight.

# Installing and Uninstalling Sensors

---

## GENERAL PRECAUTIONS

It is important that the entire sensor connector and cable connector be dry when installing, removing or replacing sensors. This will prevent water from entering the port. Once a sensor is removed, examine the connector inside the port. If any moisture is present, use compressed air to completely dry the connector or place directly in front of a steady flow of fresh air. If you suspect port contamination, follow the port cleaning procedures listed under Cleaning a Sensor Port.

Remove sensors upside down (facing the ground) to help prevent water from entering the port upon removal.

The instrument utilizes o-rings as seals to prevent water from entering the sensor ports. When the sensors are removed, the o-rings that provide the seal should be carefully inspected for contamination (e.g. debris, grit, etc.) and cleaned if necessary.

If no dirt or damage to the o-rings is evident, wipe the o-rings with a lint free cloth or lens cloth to remove the old o-ring grease. Then, lightly apply new o-ring grease (provided in the maintenance kit) to the o-rings without removing them from their groove. If there is any indication of damage, the o-ring should be replaced with an identical o-ring. At the time of o-ring replacement, the entire o-ring assembly should be cleaned.

Do not over-grease the o-rings. The purpose of the o-ring grease is to keep the o-ring in good condition. Excess grease may collect grit particles that can compromise the seal. Excess grease can also cause the waterproofing capabilities of the o-ring to diminish, potentially causing leaks. If excess grease is present, remove it using a lens cloth or lint-free cloth.

### **To remove the o-rings:**

Use a small, flat-bladed screwdriver or similar blunt-tipped tool to remove the o-ring from its groove. Do not use a sharp object to remove the o-rings. Using a sharp object could damage the o-ring groove which would allow water to enter the port resulting in permanent damage to the port and sensor. Check the o-ring and the groove for any excess grease or contamination. If contamination is evident, clean the o-ring and nearby plastic parts with lens cleaning tissue or equivalent lint-free cloth. Alcohol can be used to clean the plastic parts, but use only water and mild detergent on the o-ring itself. Using alcohol on o-rings may cause a loss of elasticity and may promote cracking. Also, inspect the o-rings for nicks and imperfections.

Before re-installing the o-rings, make sure to use a clean workspace, clean hands, and avoid contact with anything that may leave fibers on the o-ring or grooves. Even a very small amount of contamination (hair, grit, etc.) may cause a leak.

### **To re-install the o-rings:**

Place a small amount of o-ring grease between your thumb and index finger. Draw the o-ring through the grease while pressing the fingers together to place a very light covering of grease to the o-ring. Place the o-ring into its groove making sure that it does not twist or roll. Do not excessively stretch the o-ring during installation.

Use your grease-coated finger to once again lightly go over the mating surface of the o-ring.

Do not over-grease the o-rings. The excess grease may collect grit particles that can compromise the seal. Excess grease can also cause the waterproofing capabilities of the o-ring to diminish, potentially causing leaks. If excess grease is present, remove it using a lens cloth or lint-free cloth.

## **UNINSTALLING DO, PH, ORP, PH/ORP AND ISE SENSORS**

First, ensure that the entire sensor and cable bulkhead are clean and dry. Remove sensors upside down (facing the ground) to help prevent water from entering the port upon removal.

Simply unscrew the sensor from the cable by holding the sensor port end of the cable (bulkhead) in one hand and the sensor in the other hand. Twist the sensor counter-clockwise to unscrew the sensor from the port.

## **INSTALLING DO, PH, ORP, PH/ORP AND ISE SENSORS**

First, ensure both the sensor connector and sensor port on the cable are clean and dry. If any moisture is present, use compressed air to completely dry the connector or place directly in front of a steady flow of fresh air. If you suspect port contamination, follow the port cleaning procedures listed under Cleaning a Sensor Port.

To connect the sensor, grasp the sensor with one hand and the sensor port end of the cable (bulkhead) in the other. Push the sensor into the connector on the cable until it is properly seated and only one o-ring is visible. Failure to properly seat the sensor may result in damage. Twist the sensor clockwise to engage threads and finger tighten. Do not use a tool. This connection is waterproof. Please refer to the sensor installation sheet that is included with each sensor for detailed instructions.

## **UNINSTALLING A CONDUCTIVITY/TEMPERATURE SENSOR IN A QUATRO CABLE**

First, ensure that the entire sensor and cable bulkhead are clean and dry. Remove sensors upside down (facing the ground) to help prevent water from entering the port upon removal.

Remove the conductivity/temperature sensor using the installation tool to loosen the stainless steel retaining nut. Insert the tool into one of the holes in the stainless steel retaining nut. Next, use the installation tool to turn the stainless steel retaining nut counter-clockwise to loosen. Do not allow the sensor to be turned with the tool. Turning the sensor with the tool will likely damage the sensor connector. Once the stainless steel retaining nut has been completely loosened from the bulkhead, remove the sensor from the bulkhead by pulling the sensor straight out of the port.

## **INSTALLING A CONDUCTIVITY/TEMPERATURE SENSOR IN A QUATRO CABLE**

First, ensure both the sensor connector and sensor port on the cable are clean and dry. If any moisture is present, use compressed air to completely dry the connector or place directly in front of a steady flow of fresh air. If you suspect port contamination, follow the port cleaning procedures listed under Cleaning a Sensor Port.

1. Align the connectors of the sensor and the port. With connectors aligned, push the sensor in towards the bulkhead until you feel the sensor seat in its port. You will experience some resistance as you push the sensor inward, this is normal
2. Once you feel the sensor seat into the port, gently rotate the stainless steel sensor nut clockwise with your fingers, do not use the tool.
3. The nut must be screwed in by hand. If the nut is difficult to turn, STOP, as this may indicate cross threading. If you feel resistance or cross threading at any point, unscrew the nut and try again until you are able to screw the nut down completely without feeling any resistance. Damage to your cable/sensor may occur if you force the parts together.
4. Once completely installed, the nut will seat flat against the bulkhead. At this point, use the installation tool that was included with the sensor to turn the nut an additional  $\frac{1}{4}$  to  $\frac{1}{2}$  turn. Do not over tighten.
5. Please refer to the sensor installation sheet that is included with the conductivity/temperature sensor for detailed instructions.

## Cleaning a Sensor Port

---

If you suspect port contamination, you can clean the port on the cable by filling the port with Isopropyl Alcohol for 30 seconds and then dumping it out. Next, allow the port to air dry completely or blow it out with compressed air. Installing a sensor into a port that is not completely dry is likely to cause erratic and erroneous readings.

If the connector is corroded, contact your local YSI Representative or a YSI Authorized Service Center.

## Verifying Sensor Accuracy and Calibration


---

Sensor accuracy and calibration can be verified by immersing a sensor into calibration solution or YSI Confidence Solution®. Compare the readings on the Pro Plus display to the value of the solution. If the readings have drifted more than the accuracy specification of the sensor, perform a calibration before taking field measurements.

YSI Confidence Solution can be used to check the accuracy and calibration of the conductivity, pH and ORP sensors. However, to maintain the highest accuracy of the instrument, it should not be used to perform a calibration.

## Resetting a Sensor to Factory Default

---

Occasionally, it may be necessary to reset the instrument to its factory calibration default values. To reset the calibration values, press the Cal key , highlight **Restore Default Cal** and press enter. Highlight the parameter you wish to reset to default and press enter. Next, you will be asked to confirm the operation. Highlight **Yes** and press enter to confirm.



# Professional Plus Quick-Start Guide

This Quick-Start Guide is meant to serve as a quick reference in operating the Professional Plus. It is not intended to replace the information found in the Operations Manual. For your convenience, this quick start guide will enable you to unpack your instrument and get to the field quickly.

## GETTING STARTED

Unpack the instrument and install (2) C size batteries in the back of the instrument. Tighten the four screws of the battery plate on to the back of the instrument.

If necessary, install the sensors into the cable assembly by inserting the sensors into the ports and then hand tightening them. Do not use a tool and do not over tighten.

If using a 1010 cable, a sensor must be installed in port 1 for correct operation. If installing a pH/ORP combo sensor into a 1010 cable, ORP will not be measured. If using a 1020 cable, install a pH, ORP, pH/ORP, or an ISE sensor in port 1 and a DO sensor in port 2.

If using a Quatro cable, install a pH, ORP, or ISE sensor in ports label 1 and 2. A sensor must be installed in port 1 for port 2 to operate correctly. If you install a pH/ORP combo sensor into port 1 or port 2, ORP will not be measure. Install the Dissolved Oxygen sensor in the port labeled DO. Install the Conductivity/Temperature sensor in the port labeled CT following the instructions included with the sensor. For ease of installation, YSI recommends that you install a sensor into port 1 first; followed by DO installation, then port 2, and lastly C/T.

Please refer to the Getting Started Setup section of the Manual for a complete list of sensor/cable port configurations.

Install a port plug into any port that does not have an installed sensor. Attach the cable assembly to your instrument.



## INSTALLING THE DO MEMBRANE

Note: The DO sensor is shipped with a red protective cap to protect the electrode. A new membrane cap must be installed before the first use.





1. Prepare the O<sub>2</sub> probe solution according to the instructions on the bottle. After mixing, allow the solution to sit for 1 hour. This will help prevent air bubbles from later developing under the membrane.
2. Remove, and discard or save the red protective cap.
3. Thoroughly rinse the sensor tip with distilled or deionized water.
4. Fill a new membrane cap with probe solution. Avoid touching the membrane portion of the cap.
5. Thread the membrane cap onto the sensor, moderately tight. A small amount of electrolyte will overflow.
6. Screw the probe sensor guard on moderately tight.

## MENU FUNCTIONS

The Professional Plus has a menu-based interface. Press the “hot keys” to access the System, Sensor, Calibration, and File menus (from left to right at the top of the keypad). To navigate through the menus, use the up and down arrow keys to highlight a desired



menu option with a highlight bar, and press the Enter  key to activate the selection. Use the left arrow key to go back one screen. Press the Esc  key to return to the run screen or to exit an alpha/numeric entry screen. The Pro Plus will automatically power on to the Run screen.

## SETTING THE DATE AND TIME



1. Press the System  key .
2. Highlight **Date/Time** and press Enter.
3. Highlight **Date Format** and press Enter. Highlight the correct format and press Enter.
4. Highlight **Date** and press Enter. Use the keypad to enter the correct date, then highlight  on the display keypad, and press Enter.
5. Highlight **Time Format** and press Enter. Highlight the correct format and press Enter.
6. Highlight **Time** and press Enter. Use the keypad to enter the correct time, then highlight  on the display keypad, and press Enter.
7. Press Esc  to return to the Run screen.

## SETTING UP SENSORS & REPORTING UNITS

A sensor must be enabled in the **Sensor** menu for it to operate. Once a sensor is enabled, the desired units for that sensor must be selected in the **Display** menu to determine what will be displayed.

1. Press the Sensor  key.
2. Highlight **Setup** and press enter. Highlight the parameter of interest and press enter. Highlight **Enabled** and press enter to ensure a checkmark in the box. When enabling the ISE1 and ISE2 ports, you must select the correct sensor after enabling the port.
3. When Dissolved Oxygen is enabled, a submenu allows the user to select the sensor type (Polarographic or Galvanic) and membrane type being used. Highlight **Sensor Type** or **Membrane** and press **Enter** to modify these settings.
4. Press the left arrow key to return to the previous screen or press Esc  to return to the Run screen.

Once changes to the Sensor menu have been completed, you must determine which units will be reported (i.e. %, mg/L, °C, °F, etc.).

1. Select the Sensor  hot key on the keypad, highlight **Display**, and press enter.
2. Highlight the parameter you want to access and press the Enter.
3. A submenu will open allowing you to select the reporting units. Some parameters can be reported in multiple units. For example, DO can be reported in DO%, DO mg/L, and DO ppm. Other parameters, for example temperature, can only be reported in one unit. Make selections from the submenu, and then press the left arrow key to return to the Display menu or press Esc  to return to the Run screen.


## BAROMETER CALIBRATION

1. Determine your local barometric pressure (BP) in mmHg from a mercury barometer, an independent laboratory, or from a local weather service. If the





BP reading has been corrected to sea level, use the following equation to determine the true BP in mmHg for your altitude:

$$\text{True BP} = (\text{Corrected BP in mmHG}) - \{2.5 * (\text{Local Altitude in feet}/100)\}$$

2. Press the Cal  key.
3. Highlight **Barometer** and press Enter. Use the arrow keys to highlight the desired units and press Enter to confirm.
4. Highlight **Calibration Value** and press enter to adjust.
5. Use the Alpha/Numeric screen to enter your True BP, then highlight <<<ENTER>>> and press enter.
6. Highlight **Accept Calibration** and press enter to finish the calibration.


## CONDUCTIVITY, PH, AND ORP CALIBRATION

1. Press the Cal  key.
2. Highlight the parameter you wish to calibrate and press enter. For Conductivity, a second menu will offer the option of calibrating **Specific Conductance, Conductivity, or Salinity**. Calibrating one automatically calibrates the other two. An additional sub-menu will require you to select the calibration units. For pH, auto-buffer recognition will determine which buffer the sensor is in and it will allow you to calibrate up to 6 points.
3. Place the correct amount of calibration standard into a clean, dry or pre-rinsed container.
4. Immerse the probe into the solution, making sure the sensor and thermistor are adequately immersed. Allow at least one minute for temperature to stabilize.
5. For any of parameters, enter the calibration solution value by highlighting **Calibration Value**, pressing enter, and then using the alpha/numeric keypad to enter the known value. Once you have entered the value of the calibration standard, highlight <<<ENTER>>> and press enter.
6. Wait for the readings to stabilize, highlight **Accept Calibration** and press enter to calibrate.
7. For pH, continue with the next point by placing the probe in a second buffer and following the on-screen instructions or press Cal  to complete the calibration.


## DO CALIBRATION

The Pro Plus offers four options for calibrating dissolved oxygen. The first is an air calibration method in % saturation. The second and third calibrates in mg/L or ppm to a solution with a known DO concentration (usually determined by a Winkler Titration). Calibration of any option (% or mg/L and ppm) will automatically calibrate the other. The fourth option is a zero calibration. If performing a zero calibration, you must perform a % or mg/L calibration following the zero calibration. For both ease of use and accuracy, YSI recommends performing the following 1-point DO % calibration:


1. Moisten the sponge in the cal/transport sleeve with a small amount of water and install it on the probe. The cal/transport sleeve ensures venting to the atmosphere. For dual port and Quatro cables, place a small amount of water (1/8 inch) in the calibration/transport cup and screw it on the probe. Disengage a thread or two to ensure atmospheric venting. **Make sure the DO and temperature sensors are not immersed in the water.**
2. Turn the instrument on. If using a polarographic sensor, wait 10 minutes for the DO sensor to stabilize. Galvanic sensors do not require a warm up time.

3. Press the Cal  key, highlight **DO** and press enter.
4. Highlight **DO%**, then press Enter.
5. Verify the barometric pressure and salinity displayed are accurate. Once DO and temperature are stable, highlight **Accept Calibration** and press enter.

## TAKING MEASUREMENTS AND STORING DATA

1. The instrument will be in Run mode when powered on.
2. To take readings, insert the probe into the sample. Move the probe in the sample until the readings stabilize. This releases any air bubbles and provides movement if measuring DO.
3. **Log One Sample** is already highlighted in Run mode. Press enter to open a submenu. Highlight **Sites** or **Folders** and press enter to select the site or folder to log the sample to.
4. If necessary, use the keypad to create a new Site or Folder name. If Site List and Folder List are disabled in the System menu, you will not see these options when logging a sample.
5. Once the Site and/or Folder name is selected, highlight **Log Now** and press enter. The instrument will confirm that the data point was logged successfully.
6. If you would like to log at a specific interval vs. logging one sample at a time, press the System  key. Use the arrow keys to highlight **Logging** and press enter. Enable **Continuous Mode** and adjust the time **Interval** if necessary. On the Run screen, the option to log will change from **Log One Sample** to **Start Logging** based on the time interval entered.
7. During a continuous log, the **Start Logging** dialog box on the Run screen will change to **Stop Logging**.

## UPLOADING DATA TO A PC WITH DATA MANAGER

1. Make sure Data Manager and the USB drivers are installed on the PC. The USB drivers will be installed during the Data Manager installation.
2. Connect the Communications Saddle to the back of the Pro Plus instrument and use the USB cable to connect the saddle to the USB port on the PC.
3. If connecting for the first time, Windows<sup>®</sup> may prompt you through two 'New Hardware Found' Wizard in order to complete the USB driver installation.
4. Open Data Manager on the PC and turn on the Pro Plus.
5. Click on the correct instrument in Data Manager under the **Select Instrument** heading. Once you've highlighted the correct instrument, click the **Retrieve Instrument Data** tab and check **Data, GLP, Site List, Configuration** or **Select All** options to retrieve data. Click **Start**.
6. After the file transfer is complete, the data is available for viewing, printing, and exporting from Data Manager and the data can be deleted from the Pro Plus if desired.
7. Press the File  key and choose **Delete Data** if you no longer need the data on the Pro Plus.

## CONTACT INFORMATION

YSI  
1700/1725 Brannum Lane  
Yellow Springs, OH 45387  
Tel: 800-765-4974 (937-767-7241)  
Fax: 937-767-1058  
E-Mail: [proseries@ysi.com](mailto:proseries@ysi.com)  
Website: [www.ysi.com](http://www.ysi.com)

Item # 605595  
Drawing # A605595  
Revision B  
February 2009



**STANDARD OPERATING PROCEDURE**  
**MAINE VOLUNTEER RIVER MONITORING PROGRAM**  
**METHODS FOR USING THE YSI PROFESSIONAL OPTICAL DISSOLVED OXYGEN**  
**(ProODO) INSTRUMENT IN RIVERS AND STREAMS**



**Note:** The mention of brand names does not constitute recommendation of a specific company.



## Volunteer River Monitoring Program (VRMP)

### Standard Operating Procedure

#### Methods for using the YSI Professional Optical Dissolved Oxygen (ProODO) Instrument

**1. Applicability.** This standard operating procedure (SOP) is used by the Volunteer River Monitoring Program (VRMP) of the Maine Department of Environmental Protection's Division of Watershed Management. It applies to the collection of dissolved oxygen (DO) and temperature from rivers and streams in Maine using the YSI Professional Optical Dissolved Oxygen (ProODO) Instrument.

**2. Purpose.** This purpose of this SOP is to provide standardized methods for volunteer groups to determine dissolved oxygen and temperature of rivers and streams as an instantaneous reading using the YSI Professional Optical Dissolved Oxygen (ProODO) Instrument. This SOP also provides standardized methods for DEP VRMP staff to conduct quality assurance checks on volunteer groups' equipment.

#### 3. Definitions.

**A. YSI.** Yellow Springs International, manufacturer of water quality monitoring meters.

**B. Optical Dissolved Oxygen Sensor (ODO).** Sensor that measures the light emission characteristics of a luminescent reaction.

**C. Sensor Cap.** Removable sensing cover that protects the sensor.

**D. Calibration.** Set of procedures established by the manufacturer to ensure that the meter is operating properly; a critical quality assurance step in meter preparation prior to use.

**E. Probe Guard.** A protective cover for the ODO sensor cap.

**F. Calibration/Storage Sleeve.** Cover for the probe guard that keeps the probe in a moist atmosphere for storage or calibration.

#### 4. Responsibilities.

##### A. *Volunteer Monitors & Volunteer Groups*

- **Certification.** It is the responsibility of the individual obtaining this data to maintain current certification for the parameter(s) they collect if they wish their data to be entered into the VRMP database. Training will be provided to volunteers on an



annual basis by VRMP/DEP staff, and certification will last for one year from the date of training.

- **Data Recording.** It is the responsibility of the individual obtaining this data to record the results and additional qualifying information on current field sheets obtained from their affiliated watershed association or through the VRMP program of the DEP.
- **Data Quality Checks and Data Submission.** The data manager for the volunteer group will collect and enter volunteer field sheet data onto the appropriate computer file, perform quality assurance checks (refer to Section 5.10 of the Quality Assurance Program Plan), and submit data to the VRMP following protocols outlined in the volunteer group’s latest sampling and analysis plan (SAP) that has been approved by the VRMP.

### ***B. Volunteer River Monitoring Program (VRMP) Staff***

- **Oversight of Volunteer Groups and Volunteers.** VRMP staff will oversee volunteer groups and volunteers through a variety of ways including maintaining an up-to-date VRMP quality assurance program plan (QAPP); reviewing sampling and analysis plans (SAPs) of the volunteer groups; providing annual training/certification sessions for volunteers; conducting quality assurance checks on volunteer data collection and data submitted by volunteer groups and laboratories; and uploading data into the DEP’s EGAD database. These tasks are described in greater detail in the VRMP’s latest QAPP.

## **5. Guidelines and procedures.**

### ***A. YSI ProODO Instrument Preparation.***

- **First time use.** Follow manufacturer’s instructions for preparing meter for first time use. (refer to Appendix A; “Initial Setup”, pgs. 4-14 and “ODO Probe Setup” pgs. 15 – 18).
  - If you plan to use the data storage features of the meter (in addition to manually writing down data on the VRMP field data sheet), then familiarize yourself with Appendix A, “Files and Site Lists”, pgs. 25-29.
- **Beginning of field season.** Before each field season, volunteer monitoring groups shall conduct a full inspection of the meter. A new sensor cap and batteries shall be installed prior to the start of field sampling and additionally, as needed. Refer to Appendix A, “Sensor Cap Replacement”, pgs. 31-33.
  - *Note of Caution:* Only use optical tissue or cotton swabs and water to clean the sensor cap. Do not use organic solvent solutions such as acetone or alcohol with the sensor cap and do not scrub the sensor cap or the sensor lens.



In addition, each meter “setup” should be equipped with the following items so that field repairs can be undertaken as necessary:

- Extra batteries
  - Field data sheet
  - Pencil with eraser
- **Prior to field sampling.** Before each field sample collection, the volunteer shall inspect the meter including an inspection of the condition of the sensor cap and batteries.
    - (1) Batteries should be checked for charge and/or expiration.
    - (2) The sensor cap should be kept clean. To clean, gently wipe away any fouling with a lens cleaning tissue that has been moistened with water.
    - (3) Be familiar with the testing, inspection, maintenance, and calibration considerations described in sections 5.6 through 5.8 of the VRMP QAPP (MDEP, 2009).
  - **Dissolved Oxygen Calibration.** For best performance, a one-time calibration initialization should be performed when a new sensor is installed. Additionally, calibrations can be performed at the operator’s discretion but are not required. VRMP recommends verifying the instrument’s calibration on a daily basis. To verify the instrument’s calibration, place the sensor in its calibration environment and check to see that the DO% is reading its calibration value based on the barometric pressure. Refer to Appendix A, “DO% Calibration Values”, pg. 44.

Calibration can be performed manually using one of several options: Water saturated air (recommended), air saturated water, calibration to a solution with a known DO concentration (usually determined by a Winkler Titration) or zero calibration (followed by one of the previous options). For instructions, refer to Appendix A, “Calibration – Dissolved Oxygen”, pgs. 18-22. Note: VRMP staff have found that an air saturated water sample method provides the best results.

- **Barometer Calibration.** The barometer is calibrated in the factory. If the barometer requires calibration, refer to Appendix A, “Barometer”, pgs. 23-24.

### ***B. Dissolved Oxygen and Temperature Measurements.***

- **Sampling Period and Site Location.** Sampling period and site location information will be documented in the volunteer groups’ SAPs (that require approval by the VRMP) which are submitted by the volunteer groups prior to any sampling. (Detailed information regarding how volunteer groups are to obtain and document site location information can be found in VRMP SOP-02 [Documenting Site Location].)



- **Sample Timing.** Dissolved oxygen data collected between dawn and 8 am are important for assessment of attainment of DO criteria within Maine’s Water Quality Standards. But, except as naturally occurs, DO concentrations below the applicable DO criteria at any time of day signal non-attainment. If there are no DO concentrations below the criteria after 8 am, then data between dawn and 8 am must be collected to assess attainment of the criteria.
- **Re-Familiarize Yourself With the Meter and its User Manual.** Familiarize yourself with the basic operations, keypad and readouts of the meter. See Appendix A; “Key Pad”, pg. 2 and “Main Display”, pg. 6. If applicable, see Appendix A, “Logging”, pg. 13.
- **General Sampling Protocol.**
  - Record site location on data sheet.
  - Remove probe from calibration/storage sleeve.
  - Submerge probe in the water at the site where you are monitoring, as described in your group’s approved SAP. Move the probe in the sample to release any air bubbles.
  - Allow the temperature reading to stabilize and wait approximately 25-30 seconds for the DO readings to stabilize before recording the value on the field sheet.
  - Follow the instructions below measuring specific parameters.
  - Since there is no warm-up period associated with the YSI ProODO and because the calibration is stable, you may wish to turn off the instrument between readings to conserve battery power.
- **Dissolved Oxygen Measurements.**
  - (1) Review and follow the instructions for making DO measurements in Appendix A, “Taking Measurements”, pg. 24.
  - (2) In most cases, only a limited amount of initial probe movement in the water is required for taking measurements (as opposed to older styles of dissolved oxygen meters which require continuous flow or movement across their membranes).
- **Temperature Measurements.**
  - (1) Temperature will display when taking Dissolved Oxygen measurements. Refer to Appendix A, “Taking Measurements”, p. 24.
  - (2) Record temperature value displayed on the screen.
- **Quality Control.**
  - (1) At the beginning of each field season, all VRMP staff and VRMP volunteers who collect dissolved oxygen and temperature data will have a training/refresher/certification session to (re)familiarize themselves with the contents of this SOP.



(2) For every volunteer, a field duplicate shall be obtained for all parameters for at least 10% of their own sampling efforts. A field duplicate will be collected for every 10 samples monitored.

(3) Refer to the VRMP quality assurance project plan (QAPP) for more QA/QC details.

## 6. Equipment Care.

### A. *Start of field season.*

1. Follow manufacturer's directions for preparation of a new probe or renewing probe in the spring. Be sure to replace sensor cap at the start of each sampling season. (Refer to Appendix A, "Sensor Cap Replacement", pgs. 31 - 33).
  - o *Note of caution:* Avoid handling the face of the sensor cap. DO NOT use alcohol or other organic solvents to clean the face of the sensor cap. These solvents will destroy the sensor cap.
2. Use new batteries at start of each sampling season. An extra set of appropriate size batteries should be included in the meter carrying case.
3. Each D.O. meter should have the spare items for making repairs in the field. See section 5-A of this SOP for a list of necessary items.

### B. *Field Season*

1. Ideally the meter should be in water-resistant case with padding to protect it from damage.
2. Allow the case and contents to air-dry at end of each day. This may be accomplished by simply propping the lid open. When contents are very wet, remove the contents and spread out to facilitate drying.
3. Keep meter from freezing.
4. Refer to Appendix A, "Maintenance and Storage", pg. 30 and "Sensor Storage", pg. 34.
5. When the ODO sensor is not in use, it must be stored in a moist environment. Moisten the sponge in the calibration/storage sleeve with a small amount of clean water and place over the probe. If the cap dries out, it will need to be rehydrated. See Appendix A, "Rehydrating the Sensor Cap", pg. 33.

### C. *End of field season*

1. Completely dry meter, case, and all items in the case before storing.
2. Remove batteries.
3. Keep meter dry and at room temperature to prevent corrosion of electronic parts.
4. Record winterization date and equipment repairs in your volunteer group's Equipment Log.
5. Label the meter and case as 'WINTERIZED' in an obvious manner (so users will know the current status of the unit).
6. Moisten the sponge in the red protective plastic cap that was provided with the probe and place it over the sensor with the sensor cap installed. Inspect the sponge every 30 days to make sure it is still moist. If you no longer have the red



protective cap, then moisten the sponge in the calibration/transport sleeve and place this over the probe.

## 7. Specifications

Measurement	Range	Resolution	Accuracy
Temperature	-5°C - 70 °C	0.1 °C	±0.2 °C
Dissolved Oxygen (mg/L)	0-50 mg/L	0.01 or 0.1 mg/L (auto scaling)	0-20 mg/L, ± 0.1 mg/L or ± 1% of reading, whichever is greater.
			20-50 mg/L, ± 10% of the reading.
Dissolved Oxygen (%)	0-500%, air saturation	0.1% air saturation	0 to 200% air saturation, ± 1% of the reading or ± 1% air saturation, whichever is greater.
			200-500% air saturation, ± 10% of the reading.

## 8. Appendices.

### A. YSI ProODO User Manual.

YSI. March 2009. Yellow Springs, Ohio.

## 9. References

### A. DEP Standard Operating Procedures:

- Document number #:DEPLW-0890: Dissolved Oxygen and Temperature, Instantaneous Measurement using Electronic Meters
- Document number #: DEPLW-0636: Protocols for using Hanna Dissolved Oxygen and Specific Conductance/Temperature/pH Meters

### B. Maine VRMP QAPP:

- Maine Department of Environmental Protection (MDEP). 2020. Maine Volunteer River Monitoring Program (VRMP) Quality Assurance Program Plan (VRMP). Document number#: DEPLW-0984.





# Pro DO™



## USER MANUAL

# CONTENTS

---

Warranty .....	i
Introduction .....	1
Getting Started .....	1
Initial Inspection .....	1
Battery Installation .....	1
Key Pad .....	2
Initial Setup .....	4
Main Display .....	6
Menu Layout.....	6
Alpha/Numeric Entry.....	7
System .....	8
Date/Time.....	8
GLP.....	8
Language.....	12
Radix Point .....	12
Logging .....	13
Sampling Mode .....	13
Auto Shutoff .....	14
Backlight .....	14
SW Version (Software Version).....	14
Serial #.....	14
Unit ID .....	14
Optical Dissolved Oxygen (ODO™) .....	15

Item #626279  
Rev C  
Drawing # A626279  
March 2009

©2009 YSI Incorporated.

The YSI, ProODO, and ODO logos are registered trademarks of YSI Incorporated.

Microsoft and Windows are registered trademarks of the Microsoft Corporation in the United States and other countries.

Pentium is a registered trademark of Intel Corporation.

ODO Probe Setup .....	15	Dissolved Oxygen Readings.....	34
Calibration - Dissolved Oxygen .....	18	Help .....	35
Barometer .....	23	Error/Status messages .....	35
Display - Barometer.....	23	Restore Default Calibration Values .....	36
Calibration - Barometer .....	23	Accessories / Part Numbers .....	37
Temperature.....	24	Declaration of Conformity.....	40
Taking Measurements.....	24	Recycling.....	42
Files and Site Lists .....	25	Contact Information.....	43
File Memory .....	25	Ordering and Technical Support.....	43
View Data .....	25	Service Information .....	43
Site List.....	26	Appendix A-DO% Calibration Values .....	44
Folder .....	27	Appendix B-Oxygen Solubility Table .....	46
Delete Data .....	27		
Data Manager Desktop Software.....	27		
Using the Communications Saddle.....	27		
Manage Logged Data .....	28		
Real Time Data Collection.....	29		
Configure Instruments.....	29		
Maintenance and Storage .....	30		
Updating Instrument and Probe Firmware.....	30		
General Maintenance - Battery Compartment Gasket .....	30		
Sensor Maintenance - Dissolved Oxygen .....	30		
Sensor Storage .....	34		
Troubleshooting .....	34		

---

THIS PAGE LEFT INTENTIONALLY BLANK

---

## WARRANTY

---

The YSI Professional ODO™ Instrument is warranted for three (3) years from date of purchase by the end user against defects in materials and workmanship, exclusive of batteries and any damage caused by defective batteries. ProODO™ field cable/probe assemblies are warranted for two (2) years from date of purchase by the end user against defects in material and workmanship. ProODO sensor caps are warranted for one (1) year from date of purchase by the end user against defects in material and workmanship. ProODO systems (instrument & cable/probe assemblies) are warranted for 90 days from date of purchase by the end user against defects in material and workmanship when purchased by rental agencies for rental purposes. Within the warranty period, YSI will repair or replace, at its sole discretion, free of charge, any product that YSI determines to be covered by this warranty.

To exercise this warranty, call your local YSI representative, or contact YSI Customer Service in Yellow Springs, Ohio at +1 937 767-7241, 800-897-4151 or visit [www.YSI.com](http://www.YSI.com) (Support tab) for a Product Return Form. Send the product and proof of purchase, transportation prepaid, to the Authorized Service Center selected by YSI. Repair or replacement will be made and the product returned, transportation prepaid. Repaired or replaced products are warranted for the balance of the original warranty period, or at least 90 days from date of repair or replacement.

### LIMITATION OF WARRANTY

This Warranty does not apply to any YSI product damage or failure caused by:

1. Failure to install, operate or use the product in accordance with YSI's written instructions;
2. Abuse or misuse of the product;
3. Failure to maintain the product in accordance with YSI's written instructions or standard industry procedure;
4. Any improper repairs to the product;
5. Use by you of defective or improper components or parts in servicing or repairing the product;
6. Modification of the product in any way not expressly authorized by YSI.

THIS WARRANTY IS IN LIEU OF ALL OTHER WARRANTIES, EXPRESSED OR IMPLIED, INCLUDING ANY WARRANTY OF MERCHANTABILITY OR FITNESS FOR A PARTICULAR PURPOSE. YSI'S LIABILITY UNDER THIS WARRANTY IS LIMITED TO REPAIR OR REPLACEMENT OF THE PRODUCT, AND THIS SHALL BE YOUR SOLE AND EXCLUSIVE REMEDY FOR ANY DEFECTIVE PRODUCT COVERED BY THIS WARRANTY. IN NO EVENT SHALL YSI BE LIABLE FOR ANY SPECIAL, INDIRECT, INCIDENTAL OR CONSEQUENTIAL DAMAGES RESULTING FROM ANY DEFECTIVE PRODUCT COVERED BY THIS WARRANTY.

---

THIS PAGE LEFT INTENTIONALLY BLANK

---

## INTRODUCTION

---

Thank you for purchasing the YSI Professional Optical Dissolved Oxygen (Pro ODO) instrument. The YSI ProODO™ measures dissolved oxygen in water using lifetime luminescence technology and uses a digital signal to send information between the instrument and probe. Key advantages of the new ProODO include the elimination of sensor flow dependence and sensor warm-up time, greater stability, the ability to zero the sensor for more accurate measurements at low dissolved oxygen levels, and the elimination of frequent membrane/electrolyte changes. The ProODO also features a waterproof (IP-67) case, a rugged MS-8 cable connector, backlit display and keypad, user-selectable cable lengths, USB connectivity, large memory with extensive site list capabilities, and a rugged, rubber over-molded case. For product specification information, please visit [www.ysi.com](http://www.ysi.com) or contact Technical Support at 800-897-4151 (+1 937 767-7241).

Reading the entire manual before use is recommended for an overall understanding of the instrument's features.

## GETTING STARTED

---

### INITIAL INSPECTION

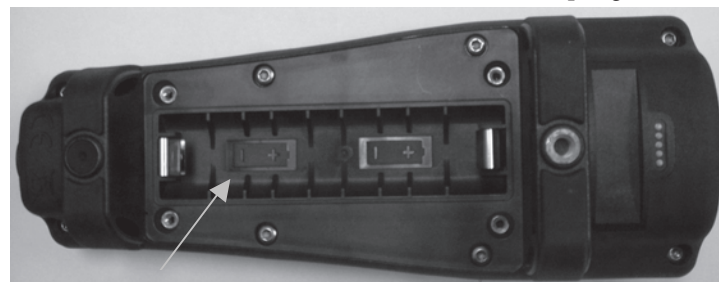
---

Carefully unpack the instrument and accessories and inspect for damage. Compare received parts with items on the packing list. If any parts or materials are damaged or missing, contact YSI Customer Service at 800-897-4151 (+1 937 767-7241) or the authorized YSI distributor from whom the instrument was purchased.

### BATTERY INSTALLATION

---

The ProODO uses 2 alkaline C-cell batteries. Battery life depends on sampling mode and usage. When used in Manual Sampling mode, under normal conditions, battery life is approximately 80 hours at room temperature. The use of Automatic Sampling mode may slightly reduce the battery life. See the **System** section of this manual for more information on Sampling Modes.



*Figure 1. ProODO with battery cover removed. Notice battery symbols indicating polarities.*

To install or replace the batteries:

1. Turn the instrument over to view the battery cover on the back.
2. Unscrew the four captive battery cover screws.
3. Remove the battery cover and install the new batteries, ensuring correct polarity alignment on the instrument or the removed cover (Figure 1).
4. Replace the battery cover on the back of the instrument and tighten the four screws. Do NOT over-tighten.

## KEY PAD

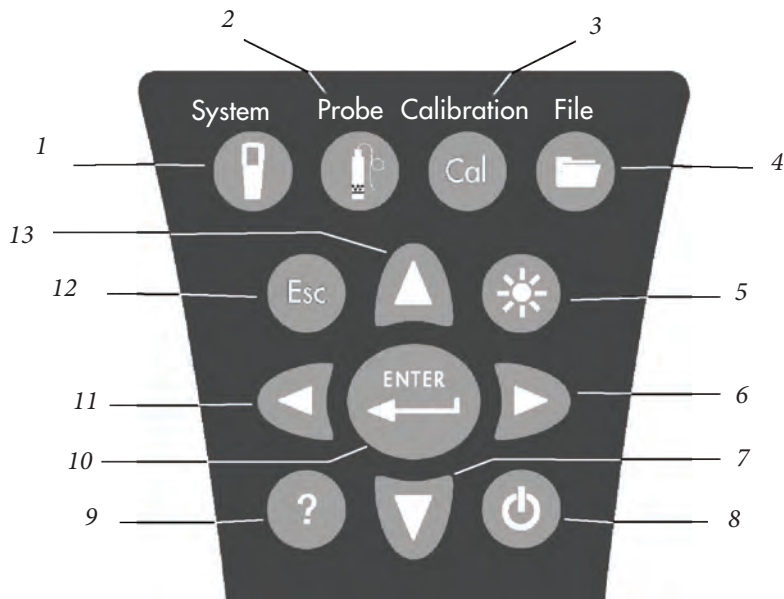


Figure 2

Number	Key	Description
1		<b>System</b> Opens System Menu from any screen. Use to adjust system settings.
2		<b>Probe</b> Opens Probe Menu from any screen. Use to setup DO probe, sensor cap, and display units.
3		<b>Calibrate</b> Opens Calibrate Menu from any screen. Use to calibrate dissolved oxygen.

Number	Key	Description
4		<b>File</b> Opens File Menu from any screen. Use to view data and GLP files, set up site and folder lists, and delete data.
5		<b>Backlight</b> Press to turn the instrument backlight on and off and to adjust the display contrast when pressed with the left or right arrow key.
6		<b>Right Arrow</b> Use to navigate right in alpha/numeric entry screens. Can be pressed simultaneously with Backlight button to increase display contrast.
7		<b>Down Arrow</b> Use to navigate through menus and to navigate down in alpha/numeric entry screens.
8		<b>Power</b> Press and hold for 2 seconds to turn the instrument on. Press to turn off.
9		<b>Help</b> Press to receive hints & tips during operation.
10		<b>Enter</b> Press to confirm selections, including alpha/numeric key selections.
11		<b>Left Arrow</b> Use to navigate left in alpha/numeric entry screens. Press to return to previous menu in all screens except alpha/numeric entry. Can be pressed simultaneously with Backlight button to decrease display contrast.
12		<b>Exit/Escape</b> Exits back to Run Screen. When in alpha/numeric entry screen, escapes to previous menu.
13		<b>Up Arrow</b> Use to navigate through menus and to navigate up in alpha/numeric entry screens

## INITIAL SETUP

Throughout the manual, the term “probe” refers to the end of the cable where the sensor is located, the term “sensor” refers to the Optical Dissolved Oxygen sensing portion of the cable/probe assembly, and the term “sensor cap” refers to the removable sensing cap that is replaced about once per year (Figure 3).

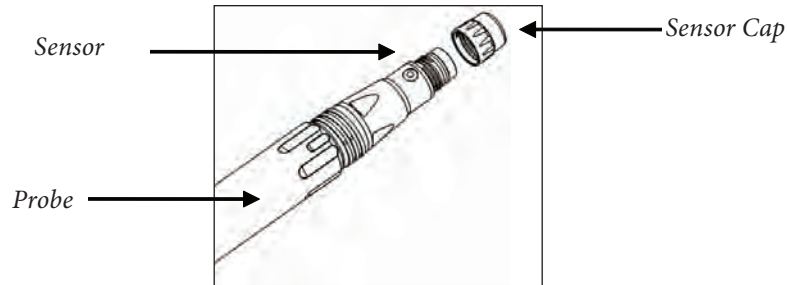


Figure 3

## UNPACKING THE ODO PROBE



*Each ProODO cable/probe assembly and replacement ODO sensor cap includes an instruction sheet with important information unique and specific to each individual sensing cap.*

Remove the cable/probe assembly from the shipping container and locate the instruction sheet included with your assembly. This instruction sheet is important because it includes the calibration coefficients for your sensor cap. After using this sheet for general probe setup, be sure to store it in a safe place in case you need to reload these calibration coefficients in the unlikely event that they are ever deleted from the probe.



*Note - A new cable/probe assembly already has a sensor cap installed and the sensor cap coefficients are preloaded into the probe at the factory.*

Preparing the probe for the first time:

1. Remove the metal probe guard from the probe by turning it counterclockwise.
2. Remove the red storage cap which contains a moist sponge from the end of the probe by pulling it straight off the sensor. Save this to use later for long term storage.

3. Reinstall the probe guard by sliding it carefully over the sensor and then threading it onto the cable/probe assembly with a clockwise rotation (Figure 4).
4. Locate the grey calibration/storage sleeve that was shipped with your probe/cable assembly. Moisten the sponge in the grey calibration/storage with a small amount of clean water.
5. Slide the calibration/storage sleeve over the probe guard to keep the probe in a moist atmosphere for storage or calibration (Figure 5). It is important to always keep your sensor in a moist environment so the sensor cap does not dry out. (See Care, Maintenance, and Storage for more information.)

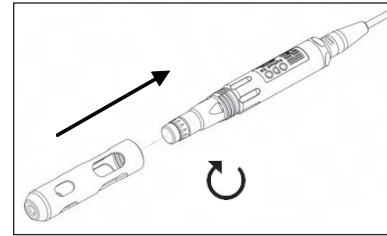


Figure 4

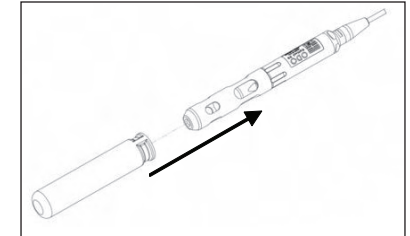


Figure 5

## CONNECTING THE PROBE/CABLE ASSEMBLY TO THE INSTRUMENT

To connect the cable, align the keys on the cable connector to the slots on the instrument connector. Push together firmly, then twist the outer ring until it locks into place (Figure 6). This MS-8 (Military Spec) connection is waterproof.

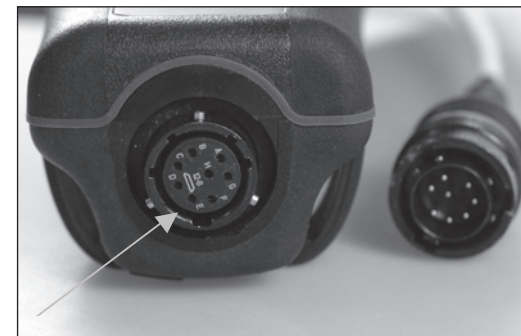

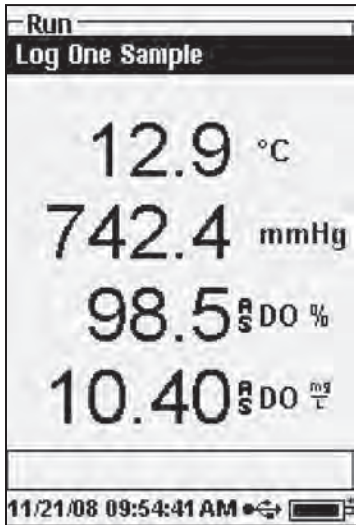


Figure 6. Note the keyed connector. The cable and instrument connectors can only be mated once the keyed sections are properly aligned. When disconnected, the cable connector and the connector on the instrument maintain an IP-67 rating.


## MAIN DISPLAY

Press and hold the Power key  for two seconds to turn the instrument on. The instrument will briefly display two splash screens then go directly to the main run mode screen. The first time the instrument is powered up, you will need to set the date and time. Follow the instructions under the **Setup | System | Date/Time** section of this manual.



The display at the left shows the run mode (main display) with temperature in °C, barometric pressure in mmHg, DO in % and mg/L as the reported parameters. The date, time and battery level are indicated at the bottom of the screen. The logging preference of Log One Sample at a time is indicated at the top of the screen.





This screen also shows the message line towards the bottom of the display above the date and time. In this case, it doesn't show a message. However, messages will appear frequently to indicate successful calibrations, saved configuration changes, etc.

A USB symbol  will show up on the bottom of the display when connected through USB with the communications saddle. The instrument will display full battery power when it is receiving power through the USB connection.

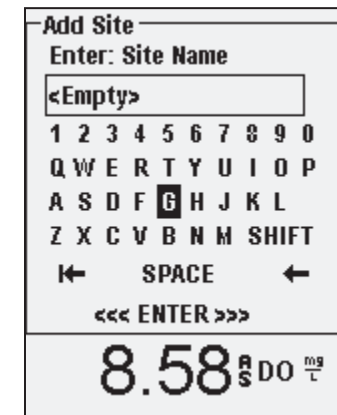
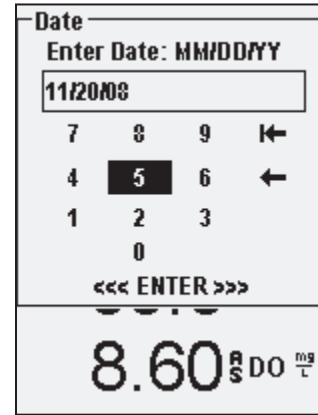


**Contrast** – the contrast adjustment can be accomplished by repeatedly pressing the backlight key and the left or right arrow key at the same time.

## MENU LAYOUT

Press Esc  at anytime in the menus to escape back to the Run screen. The left arrow  can be used to go back to the previous menu in all screens except alpha/numeric entry screens. You must use Esc to get out of the alpha/numeric screens if you want to exit before finishing or without saving changes. Functions that are enabled appear as a circle with a dot . Disabled functions appear as a circle only . In addition, some options appear as an empty box  or a box with a check mark .



## ALPHA/NUMERIC ENTRY



The numeric screens will display numbers only (shown above, left). Alpha/numeric screens will display numbers across the top and letters along the bottom rows (shown above, right). Letters appear as a common keyboard arrangement.



When an alpha or numeric character is required, the display will show the alpha/numeric entry screen. To select a character, highlight it by using the arrows to move the highlight box over the desired selection. Then, press **Enter** on the keypad to confirm the selection. After confirming the selection, it will appear in the line at the top of the display.

For capital letters or lower case entry, highlight “SHIFT” and press **Enter** on the keypad to change the characters from upper to lower case.

To delete the entire line of the current entry, highlight  and press **Enter** on the keypad. The  symbol functions as a backspace key in the alpha/numeric entry screens by deleting one character at a time. Use the “SPACE” function to add a space between characters.

When you have finished entering the correct information (16 character max), highlight <<<ENTER>>> at the bottom of the screen and press **Enter** on the keypad to confirm.

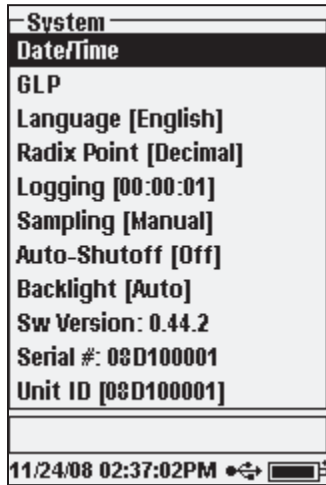


The  key cannot be used to escape to the previous menu from an alpha/numeric entry screen. Instead, use the  key to go back to the previous menu when in alpha/numeric entry screens.



# SYSTEM

Press System  to access any of the following menu items.



The System menu will allow you to access the setup options of the instrument including; **Date/Time, GLP, Language, Radix Point, Logging, Sampling, Auto Shutoff, Backlight, Sw (Software) Version, Serial #, and Unit ID.** Any item with [brackets] shows the current setting inside the brackets. For instance, in the example at the left, Radix Point is currently set to [Decimal].

## DATE/TIME

Highlight **Date/Time** from the **System** menu. Press enter to select.

**Date Format** – Highlight and press enter to open a sub menu for selecting the preferred date format: YY/MM/DD, MM/DD/YY, DD/MM/YY, or YY/DD/MM.

**Date** – Highlight and press enter to use the numeric entry screen to set the correct date.

**Time Format** – Highlight and press enter to open a submenu to select the preferred time format from 12-hour or 24-hour.

**Time** – highlight and press enter to use the numeric entry screen to set the correct time.

## GLP

The GLP or ‘Good Laboratory Practice’ file saves detailed information about calibrations. It also includes diagnostic information about the sensors. Calibrations are logged into a file, the GLP, for later review as needed. A single GLP file is utilized to store all calibration records and is capable of storing 500

records. Once the GLP file is full, the instrument will begin to overwrite the oldest record with each new calibration record.



*In order to keep all of your GLP records, periodically download the GLP to Data Manager and export it to another program. Otherwise, the instrument will overwrite the oldest record once the memory is full. Also, since Data Manager saves GLP files under the Unit ID, you must periodically export and rename the GLP file on your PC or it will be overwritten each time you upload the GLP file from the instrument.*

Several calibration parameters are saved for each calibration including optional ones that can be enabled by the user. Standard parameters include date/time stamp, calibration method, and sensor information. Optional, user selectable parameters include User ID, Probe ID, and User Fields 1 and 2.

In addition, there will be information specific to the Dissolved Oxygen or Barometer calibration record. A Dissolved Oxygen calibration record will contain the following calibration specific parameters:

### DO

Sensor - Serial Number of the Sensor

Calibration Method - Zero, %, or mg/L

Cal Value

Sensor Value - Tangent of the angle between reference and signal LED, must be within 0.2 of the default value in the sensor, typically between -0.53 and -2.17

Salinity Mode - Always manual

Salinity Value - Value entered by the user

Barometer - Barometric Pressure during calibration

Temperature - Temperature during calibration

Calibrate Status - Calibrated

A Barometer calibration record will contain the following calibration specific parameters:

### Barometer

Barometer - Calibrate value in kPa

Calibrate Status - Calibrated

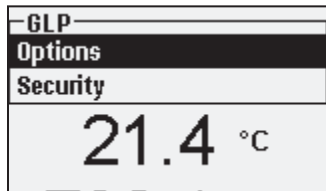
**An example of a GLP record**

(Operation Performed is % DO Calibration)

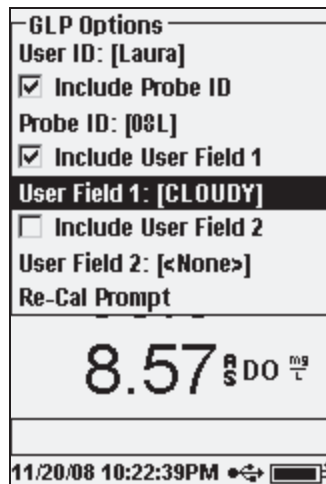
\*\*\* Calibrate – DO \*\*\*

Date: 11/01/2008 MM/DD/YY  
 Time: 04:03:05 PM  
 User ID: Tech0001  
 Probe ID: SN: 08D  
 User Field #1: Cloudy

Sensor: 08F000015  
 Method: DO Air Calibrate  
 Cal Value: 100.0 %  
 Sensor Value: -0.591150  
 Salinity Mode: Manual  
 Salinity Value: 0.000000 SAL PSU  
 Barometer: 767.09 mmHg  
 Temperature: 19.2 °C  
 Calibrate Status: Calibrated



In the System menu, highlight **GLP** and press enter to view and modify the GLP settings.



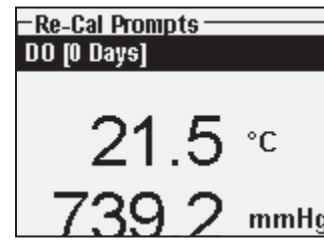
Highlight **Options** and press enter to access **User ID**, **Probe ID**, **User Defined Fields**, and **Re-Cal Prompt**.

**User ID** may be used to identify the person calibrating the instrument. Highlight **User ID** and press enter to select or edit a User ID from a list of previously entered IDs. Or, highlight **Add New** and press enter to create a new User ID using the alpha/numeric entry screen. The User ID may also be changed in the **Calibration** menu during the calibration process. The selected User ID will be stored in the GLP file with each calibration record. A User ID could be a person's initials or badge number. The character limit is 16 characters.

**Probe ID** is stored with the calibration record and may be used to distinguish one cable/

probe assembly from another, typically by serial number. Highlight **Include Probe ID** and press enter to turn this function on and off. There will be a check mark in the box when the function is enabled. Highlight **Probe ID** and press enter to add, view, edit, or select a Probe ID. Probe ID may also be changed in the **Calibration** menu during the calibration process. The character limit is 16 characters.

**User Fields 1 and 2** are stored with the calibration record and may be used to enter other parameters pertinent to the user, such as weather conditions, elevation, etc. Highlight **Include User Field 1** or **Include User Field 2** and press enter to turn this function on and off. Highlight **User Field 1** or **User Field 2** and press enter to add, view, edit, or select a User Field. The character limit is 16 characters. When enabled, a prompt for selecting a User Defined Field will appear during the calibration process.




**Re-Cal Prompt** may be used to remind the user to perform a calibration. To set a time interval, highlight **DO** and press enter to access the numeric entry screen. Enter a value in days and press enter to confirm the reminder time. To turn off the Re-cal prompt, set the reminder to zero (0) days (this is the default).

The **Security** section of the GLP menu is a password protected area. This area includes options to set a new password and to lock access to the calibration menu. When first viewing the security menu, you will be required to enter a password. Use the “shift” on the alpha/numeric screen to switch to lower case and enter “ysi123”. This is the default password.

**Protect Cal** can be enabled or disabled. When enabled, the user must know and enter the instrument's password to enter the calibration menu option. Highlight **Protect Cal** and press enter to enable () or disable () this feature.

**Set Password** allows a user to set the security password. Highlight **Set Password** and press enter. Using the alpha/numeric entry screen, enter the new password. The password can have up to 16 characters.

Contact YSI Technical Support at environmental@ysi.com or +1 937 767-7241 if you forget or misplace your password.

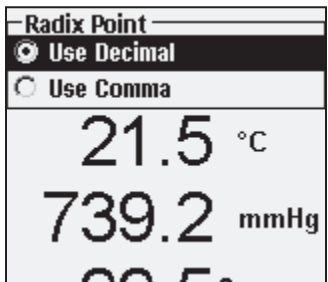
 *Once a password is set, and the GLP security screen exited, a password must be entered to make changes under GLP security. Keep passwords in a safe place.*

## LANGUAGE



To change the instrument's language setting, highlight **Language** in the **System** menu and press Enter. Highlight the desired language and press enter to confirm. Languages include English, Spanish, French, German, Italian, Portuguese, and Norwegian.

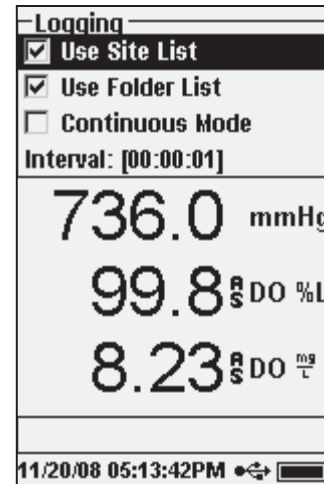
## RADIX POINT



**Radix Point** allows the user to select between a comma or a decimal in numeric radix point for displayed values. For example, 1.00 becomes 1,00 when **Use Comma** is selected. Highlight **Use Decimal** or **Use Comma** and press enter to make your selection.

## LOGGING

From the System menu, highlight **Logging** and press enter to view or change the logging options. Logging options include **Use Site List**, **Use Folder List**, **Continuous Mode**, and **Interval**.



**Use Site List** and **Use Folder List** are optional ways of filing or 'tagging' your logged data points. If these settings are enabled, you will be prompted to select a Site and/or Folder to 'tag' to logged data points. See the **File and Site Lists** section of this manual for information on creating Site and Folder Lists.

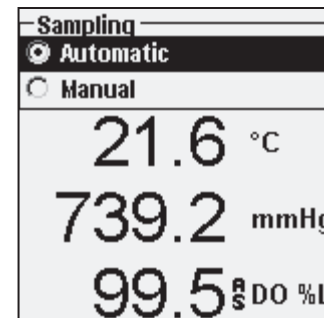
Check the box for **Continuous Mode** if you want to log samples continuously at a specific time interval. To set the length of time between logged samples, highlight **Interval** and press Enter. Enter the interval as HH:MM:SS. This interval will display at the top of the screen when you select the **Start Logging** option in run mode. If operating the unit in Manual mode, see next section, the continuous logging

interval must be set to 10 seconds or greater in order to log data.

To log one sample at a time, uncheck **Continuous Mode**.

## SAMPLING MODE

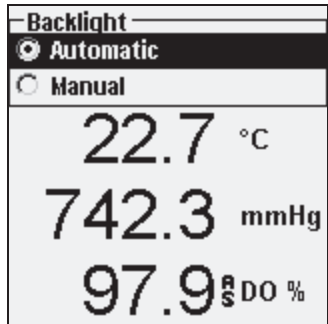
The **Sampling** mode can be set to **Automatic** or **Manual**. In **Automatic** mode, which is the default mode, the readings are constantly updated. In **Manual** mode, the readings are held or 'locked' on the display once they reach the stability of the **Auto Stable** setting in the **Probe** menu. The user must then press a key to either log the held data or update the measurements. Selecting Manual mode may increase the instrument's battery life. Highlight either Automatic or Manual and press enter to make your selection. If continuously logging in Manual mode, the logging interval must be set to 10 seconds or greater.




## AUTO SHUTOFF

**Auto Shutoff** powers the instrument off after a user specified time period. Highlight **Auto Shutoff** and press enter. Using the numeric entry screen, enter a value between 0 and 360 minutes. To disable auto shutoff, set the value to 0 (zero).

## BACKLIGHT



**Backlight** can be set to **Automatic** or **Manual**. Automatic turns the backlight on when you turn the instrument on and when you press any key. Manual allows you to turn the backlight on or off with the backlight key . When in Automatic mode, the instrument will turn the backlight off after 60 seconds without any keys being pressed. If a key is pressed during that time, the instrument will “reset” the 60 second time period. The lighted keypad will turn off after approximately 20 seconds.

## SW VERSION (SOFTWARE VERSION)

**SW Version** shows the instrument’s software version.

## SERIAL #

**Serial #** shows the instrument’s serial number and allows you to match it with the number engraved on the back of the instrument’s case. The Serial # is also the default Unit ID.

## UNIT ID

**Unit ID** is used to identify instruments in the Data Manager software included with your instrument. It is also used to identify GLP files, Site Lists, Configuration Files, and Data files transferred from the instrument to the PC. The default Unit ID is the Instrument’s serial number. To modify the Unit ID, highlight **Unit ID**, press enter and use the alpha/numeric entry screen. The character limit is 16 characters.

## OPTICAL DISSOLVED OXYGEN (ODO™)



*Each ProODO cable/probe assembly and replacement ODO sensor cap includes an instruction sheet with important information unique and specific to each individual sensing cap. This instruction sheet is important because it includes the calibration coefficients for the sensor cap. After using this sheet for general probe setup, be sure to store it in a safe place in case you need to reload these calibration coefficients in the unlikely event that they are ever deleted from the probe.*

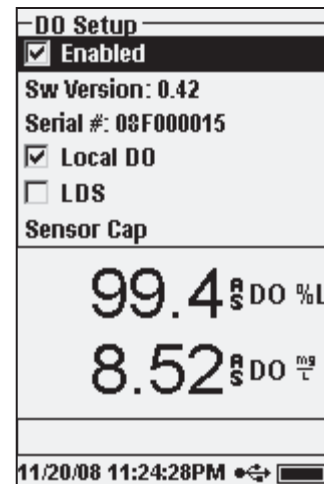
See **Initial Setup | Unpacking the ODO Probe** for initial setup instructions.



*It is important to always keep your sensor in a moist environment so the sensor cap does not dry out. (See **Maintenance and Storage** for more information.)*

## ODO PROBE SETUP

Press Probe , Highlight DO, press enter.



**Enabled** allows you to enable or disable the DO sensor. Highlight **Enabled** and press enter to activate or deactivate dissolved oxygen.

The DO Setup menu also displays the ODO probe’s **SW Version** and **Serial #**. This information is programmed into the probe at the factory and digitally sent to the instrument when the cable is connected.

**Local DO** allows for localized DO% measurements. This sets the calibration value to 100% regardless of the altitude or barometric pressure. Highlight **Local DO** and press enter to enable or disable this function. Local DO is a method for the ProODO to factor in the barometric pressure on each DO measurement.

In essence, even if the barometric pressure changes you wouldn’t notice the difference with the DO% readings in air-saturated water or water-saturated air.


Local DO is ideal for EU compliance. When Local DO is enabled, an L will appear next to DO% on the run screen. DO mg/L readings are unaffected by the selection of DO Local.

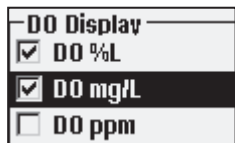
**LDS (Last Digit Suppression)** rounds the DO value to the nearest tenth; i.e. 8.27 mg/L becomes 8.3 mg/L. Highlight LDS and press enter to activate or deactivate LDS. Some users may not want to read out to the hundredths place since the DO mg/L accuracy spec is to the tenths place.

**Sensor Cap** allows you to view and enter information specific to the sensor cap installed on the probe. Highlight Sensor Cap and press enter to view the sensor cap's Serial #, Temperature Coefficient, and Sensor Cap Coefficients. This information is programmed into the sensor at the factory and sent to the instrument when the cable is connected. Since the Temperature Coefficient is programmed into the sensor at the factory, it should not be modified unless instructed by YSI Technical Support.

The **Sensor Cap Coefficients** need to be updated when the sensor cap is replaced. The sensor cap should be replaced about once per year. See the Dissolved Oxygen **Sensor Maintenance** section of this manual or the instruction sheet included with replacement sensor cap for instructions on updating the Sensor Cap Coefficients. When updating the Coefficients, the sensor cap serial # will be updated automatically based on your entries.

## DISPLAY - DISSOLVED OXYGEN

Press Probe , highlight **Display** and press enter. Highlight **DO** and press enter. Note, you will not be able to display dissolved oxygen unless it is **Enabled** in the DO Setup menu first, see previous section.



DO Display  
 DO %L  
 DO mg/L  
 DO ppm

**DO %** will show DO readings in a percent scale from 0 to 500%.

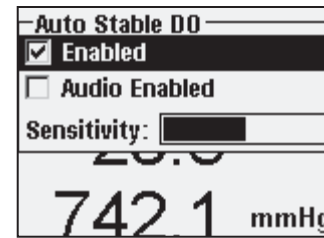
**DO mg/L** will show DO readings in milligrams per liter (equivalent to ppm) on a scale from 0 to 50 mg/L.


**DO ppm** will show DO readings in parts per million (equivalent to mg/L) on a scale from 0 to 50 ppm.

All units can be displayed simultaneously on the screen. Highlight the desired unit(s) and press enter to select. A check mark in the box next to the unit will indicate that it is enabled.

## AUTO STABLE - DISSOLVED OXYGEN

Press Probe , highlight **Auto Stable** and press enter. Highlight **DO** and press enter.



Auto Stable DO  
 Enabled  
 Audio Enabled  
 Sensitivity:   
 742.1 mmHg

**Auto Stable** indicates when a reading is stable. Highlight **Enabled** and/or **Audio Enabled** (instrument will beep when the stability is achieved) and press enter to confirm. When Auto Stable is enabled, **AS** will blink next to the parameter until it is stable. Once the parameter is stable, **AS** will stop blinking.

The Auto Stable **Sensitivity** can be decreased or increased. Highlight **Sensitivity** and use the left and right arrow keys to slide the bar. The more sensitive you make it (larger black bar) the harder it is to achieve stability in a changing environment.

The **Auto Stable** system works by examining the previous 5 readings, computing the percent change in the data and comparing that change against a % threshold value. The % threshold value is determined by the **Sensitivity** bar setting. The following chart can be used as a guide when setting the Sensitivity bar.

<i>Sensitivity selected by User</i>	<i>% Data Variance Threshold</i>
100 - Most Sensitive, Sensitivity bar is set to the far right	0.05%
75	0.62525%
50	1.275%
25	1.8875%
0 - Least Sensitive, Sensitivity bar is set to the far left	2.5%

### Example:

The instrument obtained the following data:

Reading #1 95.5 DO%  
 Reading #2 95.7 DO%  
 Reading #3 95.8 DO%  
 Reading #4 96.1 DO%  
 Reading #5 95.3 DO%

The instrument is programmed to determine the minimum and maximum data value over the previous 5 samples, and to compute the percent difference between those values. In this example, that gives a percent change of:


$$\% \text{ Change} = 100 * ((96.1 - 95.3) / 95.3)$$

$$\% \text{ Change} = 0.83\%$$

In this example, if the Sensitivity Bar is set to the far right, the Auto Stable requirement would not be met and AS would continue to blink. However, if the sensitivity bar is set to the median threshold (1.275%), the Auto Stable requirement would be met and AS would display steadily on the display.

If the **Manual Sampling** mode in the System menu is enabled, the Auto Stable function will automatically be enabled and the sensitivity setting will be used to determine when to hold the readings on the display. See Sampling Mode in the System section of this manual for more information on the two Sampling mode options.

## SALINITY CORRECTION

The last feature in the **Probe** menu is the **Salinity** correction value for the mg/L readings. Press Probe , highlight Salinity, and press enter. Then, use the numeric entry screen to enter the Salinity value of the water you will be testing from 0 to 70 ppt.

The value entered here will be used when calculating mg/L from the temperature and % saturation readings. As the salinity of water increases, its ability to dissolve oxygen decreases. For example, fully oxygenated 20 °C water at sea level with zero salinity will hold 9.092 mg/L of dissolved oxygen. If that same sample had a salinity value of 9 ppt, then it would hold 8.621 mg/L of dissolved oxygen. Therefore, to obtain accurate mg/L readings, it is important that you know the salinity of the water you will be testing and input the value into the instrument. The salinity of fresh water is typically 0-0.5 ppt and seawater is typically 35 ppt. You will also have the opportunity to enter or modify the Salinity correction value during DO calibration. Appendix B shows the oxygen solubility table.

## CALIBRATION - DISSOLVED OXYGEN

The ProODO sensor is an optical luminescent sensor which has greater stability and is less susceptible to calibration drift than traditional electrochemistry sensors. This increased stability means that the instrument may hold its calibration for many months. However, for the highest data accuracy, YSI recommends verifying the instrument's calibration on a daily basis. To verify the instrument's calibration, place the sensor in its calibration environment and check to see that the DO% is reading its calibration value based on the

barometric pressure. Refer to Appendix A for the DO% calibration values based on barometric pressure.

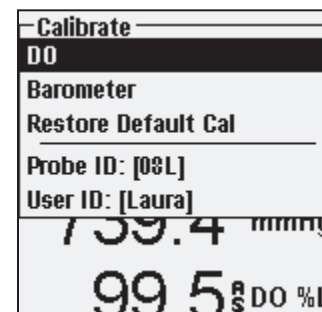
The ProODO offers several options for calibrating dissolved oxygen. The first and second methods calibrate the DO % saturation value to either water saturated air or air saturated water. The third and fourth calibrates in mg/L or ppm to a solution with a known DO concentration (usually determined by a Winkler Titration). The fifth option is a zero calibration. If performing a zero calibration, you must also perform a %, mg/L, or ppm calibration following the zero calibration. For both ease of use and accuracy, YSI recommends performing the following DO % water saturated air calibration:




*It is not necessary to calibrate in both % and mg/L or ppm. Calibrating in % will simultaneously calibrate mg/L and ppm and vice versa.*

## CALIBRATING DO % IN WATER SATURATED AIR: 1-POINT CALIBRATION

Moisten the sponge in the storage sleeve with a small amount of clean water. The sponge should be clean since bacterial growth may consume oxygen and interfere with the calibration. Make sure there are no water droplets on the sensor cap and temperature sensor and then install the storage sleeve over the probe. Make sure the DO and temperature sensors are not immersed in water. The storage sleeve ensures venting to the atmosphere. Wait approximately 5 to 10 minutes for the storage container to become completely saturated and to allow the temperature and dissolved oxygen sensors to stabilize.

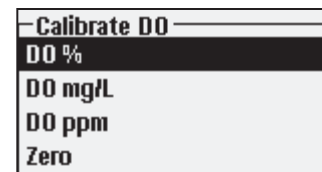


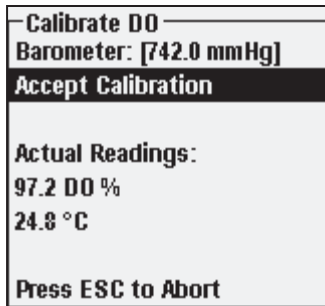
Press Calibration . If Probe ID or User ID are enabled in the System GLP menu you will be able to highlight these features and add, select, edit, or delete an ID. When enabled these IDs are stored with each calibration record in the GLP file.

After selecting the Probe ID and/or User ID if appropriate, highlight DO and press enter.



Highlight **DO %** and press enter to confirm.

The instrument will use the value from the internal barometer during calibration and will display this value in brackets at the top of the





display. Highlight the barometer value and press enter to adjust it if needed. If the barometer reading is incorrect, it is recommended that you calibrate your barometer. Note - the barometer should be reading “true” barometric pressure (see Barometer section for more information on “true” barometric pressure). If the value is acceptable, there is no need to change it or perform a barometer calibration.


Wait for the temperature and DO% values under “Actual Readings” to stabilize, then highlight **Accept Calibration** and press enter to calibrate. If User Field 1 or 2 are enabled, you will be prompted to select the fields and then press Cal  to complete the calibration. The message line at the bottom of the screen will display “Calibrating Channel...” followed by “Calibration Successful”. Press Esc  to cancel the calibration.

---

### CALIBRATING DO % IN AIR SATURATED WATER: 1-POINT CALIBRATION



---

Continuously sparge water with air using an air stone or some type of aerator until the water becomes completely saturated with air. For 500 ml of water at room temperature, it may take 60 minutes or more for the water to become completely saturated. Place the sensor in the air saturated water, be sure to immerse both the ODO and Temperature sensor into the water, and wait for the readings to stabilize (at least 2 minutes).

Press Calibration . If Probe ID or User ID are enabled in the System GLP menu you will be able to highlight these features and add, select, edit, or delete an ID. When enabled these IDs are stored with each calibration record in the GLP file.

After selecting the Probe ID and/or User ID if appropriate, highlight DO and press enter. Highlight **DO %** and press enter to confirm.

The instrument will use the value from the internal barometer and will display this value in brackets at the top of the display. Highlight the barometer value and press enter to adjust it if needed. If the barometer reading is incorrect, it is recommended that you calibrate your barometer. Note - the barometer should be reading “true” barometric pressure (see Barometer section for more information on “true” barometric pressure). If the value is acceptable, there is no need to change it or perform a barometer calibration.

Wait for the temperature and DO% values under “Actual Readings” to stabilize, then highlight **Accept Calibration** and press enter to calibrate. If User Field 1 or 2 are enabled, you will be prompted to select the fields and then press Cal  to complete the calibration. The message line at the bottom of the screen will display “Calibrating Channel...” followed by “Calibration Successful”. Press Esc  to cancel the calibration.


---


### CALIBRATING IN AIR SATURATION PERCENT (DO %): 2-POINT CALIBRATION WITH ZERO SOLUTION

---

Place the sensor in a solution of zero DO. Be sure to immerse both the ODO and Temperature sensor into the water.

A zero DO solution can be made by dissolving approximately 8 - 10 grams of sodium sulfite (Na<sub>2</sub>SO<sub>3</sub>) into 500 mL tap water or DI water. Mix the solution thoroughly. It may take the solution 60 minutes to be oxygen-free.

Press Calibration . If Probe ID or User ID are enabled in the System GLP menu you will be able to highlight these features and add, select, edit, or delete an ID. When enabled these IDs are stored with each calibration record in the GLP file.

After selecting the Probe ID and/or User ID if appropriate, highlight DO and press enter. Highlight **Zero** and press enter. Wait for the temperature and DO% values under “Actual Readings” to stabilize, then press enter to **Accept Calibration**. If User Field 1 or 2 are enabled, you will be prompted to select the fields and then press Cal  to complete the calibration. The screen will then prompt for a follow-up second point calibration.


Highlight **DO%** for the second calibration point and press enter to continue with the next point at full saturation. Rinse the sensor of any zero oxygen solution using clean water. Follow the steps under either of the DO % Saturation methods previously discussed to complete the second point.

---

### CALIBRATING IN MG/L OR PPM AS A TITRATION: 1-POINT CALIBRATION

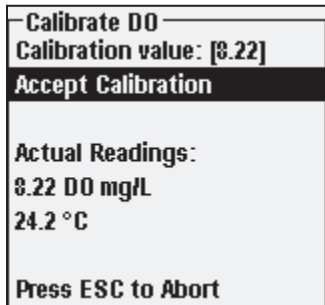
---

Place the sensor into a water sample that has been titrated by the Winkler method to determine DO concentration. Allow the sensor to stabilize.

Press Calibration . If Probe ID or User ID are enabled in the System GLP menu you will be able to highlight these features and add, select, edit, or delete

an ID. When enabled these IDs are stored with each calibration record in the GLP file.

After selecting the Probe ID and/or User ID if appropriate, highlight DO and press enter. Highlight **DO mg/L or ppm** and press enter.



Highlight **Calibration value** and press enter to manually input the sample's dissolved oxygen value. Highlight **Accept Calibration** and press enter once the temperature and Dissolved Oxygen readings have stabilized. If User Field 1 or 2 are enabled, you will be prompted to select the fields and then press Cal **Cal** to complete the calibration. After completing the calibration, the message line will display "Calibration Successful". Press Esc **Esc** to cancel the calibration.

## CALIBRATING IN MG/L OR PPM AS A TITRATION: 2-POINT CALIBRATION WITH ZERO SOLUTION

Place the sensor in a solution of zero DO. Be sure to immerse both the ODO and Temperature sensor into the water.

A zero DO solution can be made by dissolving approximately 8 - 10 grams of sodium sulfite ( $\text{Na}_2\text{SO}_3$ ) into 500 mL tap water. Mix the solution thoroughly. It may take the solution 60 minutes to be oxygen-free.

Press Calibration **Cal**. If Probe ID or User ID are enabled in the System GLP menu you will be able to highlight these features and add, select, edit, or delete an ID. When enabled these IDs are stored with each calibration record in the GLP file.

After selecting the Probe ID and/or User ID if appropriate, highlight DO and press enter. Highlight **Zero** and press enter. Wait for the temperature and DO% values under "Actual Readings" to stabilize, then press enter to **Accept Calibration**. If User Field 1 or 2 are enabled, you will be prompted to select the fields and then Press Cal **Cal** to complete the calibration. The screen will then prompt for a follow-up second point calibration.

Highlight the desired calibration units (mg/L or ppm) and press enter to continue with the next point in a known titrated value. Rinse the sensor of any zero oxygen solution using clean water. Follow the steps under One Point Calibration for mg/L or ppm for the second point.

## BAROMETER

All ProODO instruments contain an internal barometer.

### DISPLAY - BAROMETER

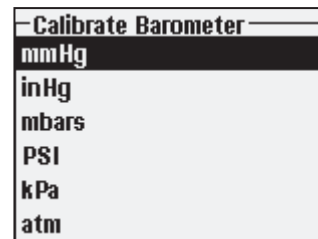
Press Probe **I**, highlight **Display**, and press enter. Highlight **Barometer**, press enter. The measurement unit options are: mmHg, inHg, mBar, PSI, kPa, or Atm. Only one unit can be displayed at a time. Select **None** if you do not want to display a barometric pressure reading.

Whether or not you choose to display the barometer reading, the barometric pressure will still be used for calibrating DO and for compensating for pressure changes if **Local DO** is enabled.

### CALIBRATION - BAROMETER

The barometer in the instrument is calibrated at the factory. If the barometer requires calibration, press **Calibrate Cal**. If Probe ID or User ID are enabled in the System GLP menu you will be able to highlight these features and add, select, edit, or delete an ID. When enabled these IDs are stored with each calibration record in the GLP file.

After selecting the Probe ID and/or User ID if appropriate, highlight barometer and press enter.



Highlight the desired unit and press enter.



Highlight **Calibration Value** and press enter to manually enter the correct "true" barometric pressure. Next, highlight **Accept Calibration**, and press enter. If User Field 1 or 2 are enabled, you will be prompted to select the fields and then press Cal **Cal** to complete the calibration. After completing the calibration, the message line will display "Calibration Successful". Press Esc **Esc** to cancel the calibration.






Laboratory barometer readings are usually “true” (uncorrected) values of air pressure and can be used “as is” for barometer calibration. Weather service readings are usually not “true”, i.e., they are corrected to sea level, and therefore cannot be used until they are “uncorrected”. An approximate formula for this “uncorrection” is below:

$$\text{True BP} = [\text{Corrected BP}] - [2.5 * (\text{Local Altitude in ft. above sea level}/100)]$$


## TEMPERATURE

All probe/cable assemblies have built-in temperature. Temperature calibration is not required nor is it available. To set the units, press Probe , and select **Display**. Highlight **Temperature** and press enter. Highlight the desired temperature units of °F, °C, or K and press enter to confirm the selection. Only one temperature unit may be displayed at a time. You may also choose to not display temperature. If you choose not to display temperature, dissolved oxygen readings will still be temperature compensated.

## TAKING MEASUREMENTS

- To take readings, insert the probe into the sample. Move the probe in the sample to release any air bubbles and to provide a fresh sample to the sensor cap. This movement is only necessary when first inserting the probe into the sample. Since the ProODO utilizes optical luminescent technology, continuous sample movement or stirring is not required. The probe will fit into a 300 mL BOD bottle for taking initial and final BOD readings. For best results in a BOD bottle, a stirring device should be used to properly mix the sample and to keep solids from settling at the bottom.
- Allow the temperature readings to stabilize and wait approximately 25-35 seconds for the DO readings to stabilize.
- Log One Sample is already highlighted in Run mode. Press Enter to open a submenu. Highlight Sites or Folders and press Enter to select the site or folder to log the sample to.
- If necessary, use the keypad to create a new Site or Folder name. If Site List and Folder List are disabled in the **System** menu, you will not see these options when logging a sample.

- Once the Site and/or Folder name is selected, highlight **Log Now** and press Enter. The instrument will confirm that the data point was successfully logged.

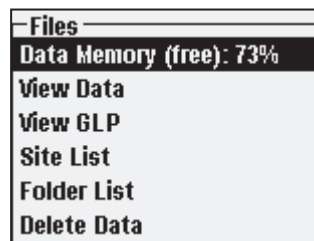
If you would like to log at a specific interval vs. logging one sample at a time or vice versa, press **System** , then highlight **Logging** and press Enter. Select **Continuous Mode** and adjust the time Interval if necessary. On the Run screen, the option to log will change from Log One Sample to Start Logging based on the time interval entered in the Logging Menu. Note – When utilizing the Manual sampling mode, the Continuous Logging Interval must be set to 10 seconds or greater.

During a continuous log, the Start Logging dialog box on the Run screen will change to Stop Logging. Press Enter to stop continuous logging.

Note - There is NO WARM-UP period associated with the ProODO sensor so you may wish to turn off the ProODO instrument between readings to conserve battery power.

## FILES AND SITE LISTS

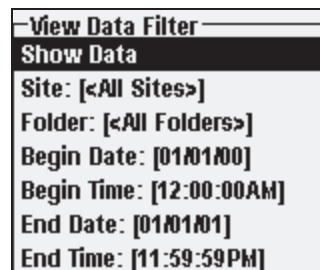
### FILE MEMORY



To view the file memory, press **File** .

The **Data Memory** shows a percentage indicating the amount of memory available. If the file memory is near 0%, files should be downloaded to a PC and/or deleted to free up memory.

### VIEW DATA



Press **File** , highlight **View Data**, press enter. Configuring your data view:

**Site:** will allow you to view data from one particular site or all sites. Highlight Site, press enter, and select the site you wish to view data from or select All Sites to view data from all sites.

**Folder:** will allow you to view data from one particular folder or all folders. Highlight **Folder**, press enter, and select the file you wish to view data from or select All Folders to view data from all folders.

**Begin** and **End** will allow you to view data that was collected between two dates. Highlight Begin and/or End, press enter, and use the numeric entry screen to select the dates you wish to view.

View Filtered Log Data		
<All Sites><All Folders>		
	°C	mmHg DO
11/05/08		
03:07:41PM	24.5	735.2 91
03:07:43PM	24.5	735.3 91
03:07:44PM	24.5	735.2 91
03:07:45PM	24.5	735.3 91
03:07:45PM	24.5	735.2 91

11/21/08 04:15:16PM

After making your selections in the Data Filter, highlight **Show Data** and press enter. The data will have date and time stamps. You will likely have to scroll up and down and side to side using the arrow keys to completely view the data file.

## SITE LIST

Site List
TANK1
TANK2
DOCK1
Add new...
744.5 mmHg
107.2 DO %
8.92 DO mg/L

11/21/08 04:55:52PM

To modify the Site List, press **File**, highlight **Site List**, and press enter. Enter new site names or edit existing sites with the alpha/numeric entry screen. Site lists can also be created and edited on your PC with Data Manager and then downloaded to the instrument.

## FOLDER

To modify the Folder List, press **File**, highlight **Folder List**, and press enter. Enter new Folder names or edit existing folders with the alpha/numeric entry screen.

## DELETE DATA

Press **File**, highlight **Delete Data**, and press enter. Enter the criteria for the data you wish to delete in the Delete Data Filter, then highlight Delete Data and press enter.

## DATA MANAGER DESKTOP SOFTWARE

Data Manager is provided with the purchase of a ProODO Instrument. Data Manager is a powerful Windows® based software that will allow you to easily manage logged data, set up instruments, and conduct real time studies.

Data Manager needs to be installed on a PC before use. Once the communications saddle is connected to an instrument and the PC, the Data Manager software will recognize the attached instruments. Data Manager will identify the connected instruments by their Unit ID.

From the 'home' screen of Data Manager, you can select one of the following functions: Retrieve Instrument Data, Real Time Instrument Data, Instrument Configuration, or View Saved File/Data.

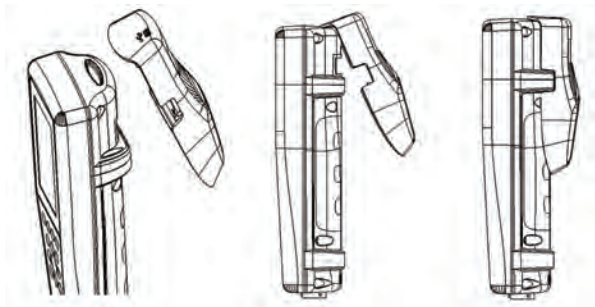
## USING THE COMMUNICATIONS SADDLE



**WARNING:** DO NOT connect the Communications Saddle to your PC before installing Data Manager. The Communication Saddle drivers MUST be installed prior to connecting it to your PC. The drivers will install automatically during the Data Manager installation. The first time the saddle is connected to the PC, you may have to walk through a couple of installation wizards. For detailed instruction, please refer to the Readme file located on the CD that was included with your instrument.

A PC will recognize the Communications Saddle (saddle) as a YSI water quality instrument with or without the handheld installed in the saddle.

To connect to a ProODO, simply align the saddle to the oval section on top of the instrument and push it down to snap it in place (Figure 7).



*Figure 7. Locate the oval alignment groove at the top of the instrument and inside the saddle. Insert the saddle into this oval groove. Press the saddle towards the back of the instrument until it snaps into place.*

Connect the USB cable to the top of the saddle and to a USB port on the PC. Once Data Manager is launched, the program will recognize all saddles with instruments connected to the PC.

The instrument will be powered through the saddle and USB connection when connected to the PC.

## **MANAGE LOGGED DATA**

---

Data that has been logged to the ProODO can be uploaded to the PC via the provided USB saddle. You can upload sensor data, GLP files, site lists, and instrument configuration files individually or all at once. After connecting the instrument to the PC via the USB saddle and cable and launching Data Manager, click the **Retrieve Instrument Data** tab. Click on the Instrument's Unit ID you would like to retrieve data from, then select the files you would like to retrieve and click Start.

Once the sensor data is uploaded to the PC, you can graph and view tabular data by instrument Unit ID, date/time, site name, and/or folder name. This allows you to configure the report according to your needs. You can select to view all data from all instruments, or select a certain date/time range for only a few specific instruments, there are multiple ways to view the data. Once the report has been defined, you will be able to print the graph and/or export the table.

Data Manager takes information management one step further and allows you to delete specific points instead of entire files. This allows you to clean up data that is no longer needed or that may have been collected erroneously, for example, when the sensor was out of the water. If you can not delete data due to regulation and compliance purposes, Data Manager has the solution. While viewing logged data or real time data, you have the ability to 'tag' individual data points with comments.

In addition to sensor data, you will be able to view GLP files, site lists, and configuration files that have been uploaded from the instrument. These can be printed and exported as well.

## **REAL TIME DATA COLLECTION**

---

Data Manager allows you to view real time data on the PC.

After selecting your instrument, click the Real Time Instrument Data tab. Next, input your sample interval, site/folder name, select the parameters you wish to view and click OK. You must click Start on the next screen to begin your real time study. Choose to hide the table or graph by unchecking the box next to these options. Click Stop, then Edit Setup to change the Y-scale min/max of the graph, to select different colors, or to name your graph. Add a comment to a data point, by clicking in the comment field of the table next to the data point. You may also Print the graph and Export the data for viewing in another program.

## **CONFIGURE INSTRUMENTS**

---

Data Manager allows for easy and quick configuration of single or multiple instruments. Once you have uploaded a site list or configuration file, you can edit it as needed, save it, and download it to other instruments. You no longer need to configure each instrument individually. By using the same configuration file for all instruments, you can rest assured that all instruments will have identical settings.

New site lists and configuration files can be created in Data Manager. These lists and files can be downloaded to one or multiple instruments. Save time by creating these files on your PC and downloading them to the instrument as opposed to creating them on the instrument.

Minimum system requirements for Data Manager are a system with Windows® 2000 with SP4 (minimum) or Windows® XP with SP2 (minimum), 300 MHz or higher Pentium®-compatible CPU, 128 MB of RAM or higher, 80 MB or more of free hard-disk space, USB 2.0, and Microsoft® .NET.

## MAINTENANCE AND STORAGE

This section describes the proper procedures for care, maintenance and storage of the ProODO. The goal is to maximize their lifetime and minimize down-time associated with improper sensor usage.

### UPDATING INSTRUMENT AND PROBE FIRMWARE

The instrument and probe's firmware can be updated via [www.ysi.com](http://www.ysi.com). There you will find the new firmware files and instructions on how to update the instrument and/or probe. There is no need to send the instrument back to the factory for upgrades.

### GENERAL MAINTENANCE - BATTERY COMPARTMENT GASKET

The instrument utilizes a gasket as a seal to prevent water from entering the battery compartment. If the gasket and sealing surfaces are not maintained properly, it is possible that water can enter the battery compartment. This could severely damage the battery terminals causing loss of battery power and corrosion to the battery terminals. Therefore, when the battery compartment lid is removed, the gasket that provides the seal should be carefully inspected for contamination (e.g. debris, grit, etc.) and cleaned if necessary. If contamination is evident, clean the gasket and nearby plastic parts with lens cleaning tissue or equivalent lint-free cloth. Alcohol can be used to clean the plastic parts, but use only water and mild detergent on the o-ring itself. Also, inspect the gasket for nicks and imperfections.

**i** Using alcohol on a gasket may cause a loss of elasticity and may promote cracking.

### SENSOR MAINTENANCE - DISSOLVED OXYGEN

#### CLEANING THE SENSOR CAP

The Sensor Cap should be kept clean since some types of fouling may consume oxygen which could affect the dissolved oxygen measurements. To clean the Sensor Cap, gently wipe away any fouling with a lens cleaning tissue that has been moistened with water. Do not use organic solvents to clean the Sensor Cap. Using an organic solvent to clean the Sensor Cap may cause permanent damage to the cap. For example, alcohol will dissolve the outer paint layer and other organic solvents will likely dissolve the dye in the cap

### SENSOR CAP REPLACEMENT

The Sensor Cap should be replaced about once per year but may last longer. It should also be replaced if it is cracked or damaged (see Troubleshooting section for instruction on how to inspect the cap for damage). The instruction sheet shipped with the replacement ODO sensor cap includes the calibration coefficients specific to your sensor cap.

**i** **IMPORTANT** - Be sure to save the ODO Sensor Cap instruction sheet in case you need to reload the calibration coefficients.

The replacement ODO Sensor Cap is shipped in a humidified container and the package should not be opened until immediately before sensor cap replacement. Once the sensor cap has been installed on the ODO sensor as described below, it is important to keep the sensor in a 100% humid environment. Therefore, the ODO sensor should be stored either in the grey calibration/storage sleeve with the sponge moistened or immersed in water, see Sensor Storage for more information. If the sensor dries out, refer to the Rehydration procedure in this manual.

Refer to Figure 8 below when following the instructions for replacing the cap.

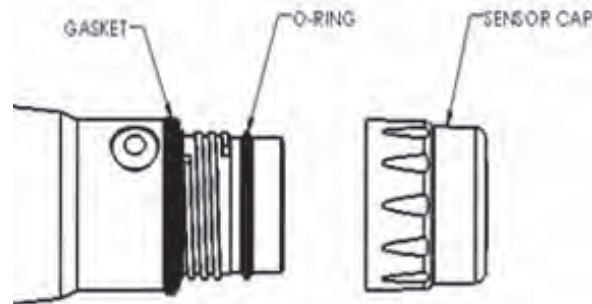


Figure 8


**!** **Caution:** Avoid touching the sensing end of the sensor cap during the following maintenance procedures.

1. Remove the old sensor cap assembly from the sensor by grasping the probe body with one hand and then rotating the sensor cap counterclockwise until it is completely free. Do not use any tools for this procedure.

- Inspect the o-ring on the probe for damage. If there is any indication of damage, carefully remove the o-ring and replace it with the new o-ring included with the replacement sensor cap. Do not use any tools to remove the o-ring.
- Ensure that the o-ring installed on the probe is clean. If necessary, wipe clean with a lint free cloth or replace the o-ring as described in the previous step.
- Locate the o-ring lubricant included with the new sensor cap. Apply a thin coat of o-ring lubricant to the installed o-ring. After application, there should be a thin coat of o-ring lubricant on the o-ring only. Remove any excess o-ring lubricant from the o-ring and/or probe with a lens cleaning tissue.
- Remove the new sensor cap from its hydrated container and dry the inside cavity of the sensor cap with lens cleaning tissue. Make sure that the cavity is completely dry before proceeding with the installation. Next, clean the clear surface of the sensor on the end of the probe with lens cleaning tissue.
- Using clockwise motion, thread the new sensor cap onto the probe assembly until it is finger-tight. The o-ring should be compressed between the sensor cap and probe. Do not over-tighten the sensor cap and do not use any tools for the installation process.
- After installing the new sensor cap, store the sensor in either water or in humidified air in the calibration sleeve.
- Follow the procedures below for configuring the ProODO instrument for the new Sensor Cap.

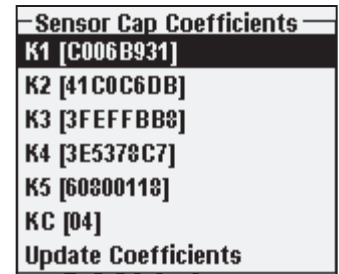
## CONFIGURING PROODO INSTRUMENT FOR NEW SENSOR CAP

After installing a new Sensor Cap, connect the probe/cable assembly to the ProODO instrument and turn the instrument on. Locate the Calibration Code Label at the top of the instruction sheet and note the six numbers which are listed as K1 through K5 and KC. These six numbers contain the calibration code for this particular sensor cap. Follow the instructions below to enter the new calibration coefficients into your existing ODO instrument.

- Press the **Probe** , highlight DO, and press enter.
- Highlight **Sensor Cap** and press enter.
- Highlight **Sensor Cap Coefficients** and press enter.



- Highlight each coefficient in turn (K1 through KC) and use the numeric entry screen to enter the corresponding new coefficient from the Calibration Code Label. Press Enter after each entry and then proceed to the next K selection.
- After all the new coefficients have been entered, highlight Update Sensor Cap Coefficients and press the Enter.
- A message will appear warning that you will be overwriting the current sensor cap coefficients and you should confirm that you wish to carry out this action. Highlight Yes and press enter to confirm the new coefficients.



After updating the Coefficients, the Serial # in the Sensor Cap menu will be updated automatically based on your entries. The Temperature Coefficient listed in the Sensor Cap menu is programmed into the sensor at the factory and should not be modified unless instructed by YSI Technical Support.

If errors are made in entering the Sensor Cap Coefficients, the instrument will block the update and an error message will appear on the display. If you see this error message, re-enter the coefficients and check them carefully for correct transcription from the Calibration Code Label prior to selecting Update Sensor Cap Coefficients. If you continue to get an error message after several entry attempts, contact YSI Technical Support for assistance.

After entering the new Sensor Cap coefficients, perform a 1-point DO calibration.

## REHYDRATING THE SENSOR CAP

The Sensor Cap must remain in a moist environment; see Sensor Storage for storage recommendations. If you inadvertently leave your sensor exposed to ambient air for a period of more than approximately 8 hours it may dry out. If the sensor cap is allowed to dry out, it is likely to drift slightly at the beginning of your next study unless it is rehydrated. If the cap dries out, you can rehydrate it by soaking the probe tip with the sensor cap installed in warm tap water for 24 hours. After rehydration is complete, recalibrate and be sure to store the probe in a moist environment.

---

## SENSOR MAINTENANCE - TEMPERATURE

---

You must keep the temperature portion of the sensor free of build up. Other than that, the sensor requires no maintenance. A soft bristle brush, like a tooth brush can be used to scrub the temperature sensor if needed.

---

## SENSOR STORAGE

---

---

### SHORT-TERM STORAGE

---

When the ODO Sensor is not in use, it **MUST BE STORED IN A MOIST ENVIRONMENT**, i.e., either in water or in water-saturated air. If the sensor cap is allowed to dry out by exposure to ambient air, it is likely to drift slightly at the beginning of your next study unless it is rehydrated.

For short-term storage (<30 days), moisten the sponge in the calibration/storage sleeve with a small amount of clean water and place this over the probe with the sensor cap installed. This will provide a 100% saturated air environment.

---

### LONG-TERM STORAGE

---

For long-term storage (>30 days), remove the batteries from the instrument. Moisten the sponge in the red protective plastic cap that was provided with the probe and place it over the sensor with the sensor cap installed. Inspect the sponge every 30 days to make sure it is still moist. If you no longer have the red protective cap, then moisten the sponge in the calibration/transport sleeve and place this over the probe.

Alternatively, you can place the probe with sensor cap directly in a beaker or other container of water, making sure that the water does not evaporate over time.

*Long-term Storage: -5 to 70°C (23 to 158°F)*

---

## TROUBLESHOOTING

---

---

### DISSOLVED OXYGEN READINGS

---

Erroneous dissolved oxygen readings typically indicate a need to clean the sensor cap, replace the sensor cap, and/or recalibrate the instrument. First, verify the sensor is properly setup in the Probe menu. Next, clean the sensor cap following the instructions in the Maintenance and Storage section of this manual and then perform a calibration. If erroneous readings persist, follow the steps on the next page to inspect the sensor cap for damage and then attempt to recalibrate the instrument. If the problem continues, try to rehydrate the sensor cap then

recalibrate. If you are still getting erroneous dissolved oxygen readings, try replacing the sensor cap and then recalibrate. If the erroneous readings continue, contact YSI Technical Support to help determine the next step.

---

### INSPECTING THE SENSOR CAP FOR DAMAGE

---



*Caution: Avoid touching the sensing end of the sensor cap during the following maintenance procedures.*

If readings seem to be in error or are jumpy, remove the sensor cap from the sensor by grasping the probe body with one hand and then rotating the sensor cap counterclockwise until it is completely free. Avoid using tools for the removal of the cap if at all possible.

Inspect the sensor cap assembly for any cracks or damage. If damage has occurred, contact YSI Customer Service to order a replacement sensor cap.

Inspect the o-ring on the probe and the gasket at the top of the threads for damage. If there is any indication of damage, carefully remove these parts and contact YSI Technical Support to obtain a new o-ring and/or gasket. Avoid using tools to remove the o-ring as damage to the sealing surfaces could result.


Before reinstalling the sensor cap, make sure that the cavity is completely dry before proceeding with the installation. If water is found, dry the cavity with lens cleaning tissue. Finally, clean the clear window on the end of the probe with lens cleaning tissue.

After reinstalling the sensor cap, perform a calibration and then reevaluate the quality of the dissolved oxygen readings. If problems persist, try rehydrating or replacing the sensor cap.

---

### HELP

---

During use of the ProODO instrument press **Question**  from any screen to view help messages directly on the display.

---

### ERROR/STATUS MESSAGES

---

If readings for a certain parameter are over range you will see a series of +++++ and if the readings are under range you will see a series of ----- plus the error message along the bottom of the screen. If you see a series of ?????, that will indicate that a certain parameter cannot be calculated. This could be due to a

connection issue between the cable and instrument. The following are some of the potential messages:




<i>Message</i>	<i>Description and Recommended Action</i>
Probe Temp over range	Temperature is over 100° C or reading erroneously. Check cable connection and ensure Temp sensor is clean.
Probe Temp under range	Temperature is under -10° C or reading erroneously. Check cable connection and ensure Temp sensor is clean.
DO over range	DO% saturation is over 550%. Check sensor cap and recalibrate.
DO under range	DO% saturation is under -5%. Check sensor cap and recalibrate.
Barometer over range	Barometric pressure is reading over 988 mmHg. Calibrate barometer.
Barometer under range	Barometric pressure is reading under 375 mmHg. Calibrate barometer.
ODO Communications Error	No communication between the instrument and cable. Check cable connection.
Clock Battery Low	Internal battery for real time clock has low voltage. Contact Technical Support.
Measurements Locked!	Measurements are held in Manual Sampling mode. Select Update Measurements or Log Held Data.





**Illegal Value** may appear during alpha/numeric entry on the message line. This only appears if the values entered do not match the formatting. This will also appear in the GLP security area if the password is incorrect.



### RESTORE DEFAULT CALIBRATION VALUES

Occasionally, the instrument may need to have the factory calibration default values restored. In order to accomplish this press Calibrate **Cal**, highlight **Restore Default Cal** and press enter. Select the parameter you wish to restore, either DO or Barometer, and press enter. After selecting barometer or DO, you will be asked to confirm the operation. Highlight Yes and press enter.

## ACCESSORIES / PART NUMBERS

<i>Part Number</i>	<i>Description</i>
626281	ProODO Instrument 
626250-1, -4, -10, -20, -30, -40, -50, -60, or -100	1, 4, 10, 20, 30, 40, 50, 60, or 100-meter probe/cable assembly*
626320	Replacement Sensor Cap
605604	Communications saddle kit 
605515	Data Manager desktop software
603075	Carrying case, soft-sided 
603076 and 603078	Extended length flow cell and single port adapter. Both items are required for use with a ProODO

<i>Part Number</i>	<i>Description</i>
603074	Carrying case, hard-sided 
603069	Belt clip 
063517	Ultra clamp 
063507	Tripod clamp 

<i>Part Number</i>	<i>Description</i>
603062	Cable management kit 
605978	Weight, sensor/cable, 4.9 oz. 
063019	Weight, sensor/cable, 24 oz., 3"
063020	Weight, sensor/cable, 51 oz., 6"
603070	Shoulder strap

\*All cables include a temperature and dissolved oxygen sensor. Special order cables in 10 meter increments from 60 to 100 meters are available.



# DECLARATION OF CONFORMITY

The undersigned hereby declares on behalf of the named manufacturer under our sole responsibility that the listed product conforms to the requirements for the listed European Council Directive(s) and carries the CE mark accordingly.

<b>Manufacturer:</b>	YSI Incorporated 1725 Brannum Lane Yellow Springs, OH 45387 USA
<b>Product Name:</b>	Professional ODO Water Quality Instrument
<b>Model Numbers</b>	
<b>Instrument/Accessory:</b>	ProODO (626281) / ProComm (605604)
<b>Probe/Cable Assemblies:</b>	626250
<b>Conforms to the following:</b>	
<b>Directives:</b>	EMC 2004/108/EC RoHS 2002/95/EC WEEE 2002/96/EC
<b>Harmonized Standards:</b>	<ul style="list-style-type: none"> <li>• EN61326-1:2006, Electrical equipment for measurement, control, and laboratory use – EMC requirements – Part 1: General Requirements</li> <li>• EN61326-2-3:2006, Electrical equipment for measurement, control and laboratory use – EMC requirements – Part 2-3: Particular Requirements – Test configuration, operational conditions, and performance criteria for transducers with integrated or remote signal conditioning.</li> <li>• EN61000-3-2:2006, Electromagnetic compatibility (EMC) – Part 3-2: Limits – Limits for harmonic current emissions (equipment input current &lt; 16A per phase).</li> <li>• EN61000-3-3:1995 +A1:2001 +A2:2005, Electromagnetic compatibility (EMC) – Part 3: Limits – Section 3: Limitation of voltage fluctuations and flicker in low-voltage supply systems for equipment with rated current &lt; 16A.</li> </ul>

<b>Supplementary Information:</b>	All performance met the continuous unmonitored operation criteria as follows: 1. ESD, EN61000-4-2, Performance Criterion B 2. Radiated Immunity, EN61000-4-3, Performance Criterion A 3. EFT, EN61000-4-4, (EFT) Performance Criterion B 4. Surge, EN61000-4-5, Performance Criterion B 5. Conducted Immunity, EN61000-4-6, Performance Criterion A 6. Voltage Interrupts, EN61000-4-11, Performance Criterion B 7. RF Emissions, EN55011:1998, A1:1999 Class B equipment
<b>Authorized EU Representative</b>	YSI Hydrodata Ltd Unit 8, Business Centre West, Avenue 1 Letchworth, Hertfordshire, SG6 2HB UK



Signed: Lisa M. Abel  
Title: Director of Quality

Date: 26 November 2008

The undersigned hereby declares on behalf of the named manufacturer under our sole responsibility that the listed product conforms to the requirements for electrical equipment under US FCC Part 15 and ICES-003 for unintentional radiators.

<b>Manufacturer:</b>	YSI Incorporated 1725 Brannum Lane Yellow Springs, OH 45387 USA
<b>Product Name:</b>	Professional ODO Water Quality Instrument
<b>Model Numbers</b>	
<b>Instrument/Accessory:</b>	ProODO (626281) / ProComm (605604)
<b>Probe/Cable Assemblies:</b>	626250
<b>Conforms to the following:</b>	
<b>Standards:</b>	<ul style="list-style-type: none"> <li>• FCC 47 CFR Part 15-2008, Subpart B, Class B, Radio Frequency Devices</li> <li>• ICES-003:2004, Digital Apparatus</li> </ul>
<b>Supplementary Information:</b>	Tested using ANSI C63.4-2003 (excluding sections 4.1, 5.2, 5.7, 9, and 14)



Signed: Lisa M. Abel  
Title: Director of Quality

Date: 26 November 2008

The undersigned hereby declares on behalf of the named manufacturer under our sole responsibility that the listed product conforms with the Australian and New Zealand Electromagnetic Compatibility (EMC) requirements for generic products to be used in residential, commercial, and light industrial environments.

<i>Manufacturer:</i>	YSI Incorporated 1725 Brannum Lane Yellow Springs, OH 45387 USA
<i>Product Name:</i>	Professional ODO Water Quality Instrument
<i>Model Numbers</i>	
<i>Instrument/Accessory:</i>	ProODO (626281) / ProComm (605604)
<i>Probe/Cable Assemblies:</i>	626250
<i>Conforms to the following:</i>	
<i>Standards:</i>	• AS/NZS 4251.1:1999, Electromagnetic Compatibility (EMC) – Generic emission standard – Part 1: Residential, commercial, and light industry.



Signed: Lisa M. Abel  
Title: Director of Quality

Date: 26 November 2008

## RECYCLING

YSI is committed to reducing the environmental footprint in the course of doing business. Even though materials reduction is the ultimate goal, we know there must be a concerted effort to responsibly deal with materials after they've served a long, productive life-cycle. YSI's recycling program ensures that old equipment is processed in an environmentally friendly way, reducing the amount of materials going to landfills.

- Printed Circuit Boards are sent to facilities that process and reclaim as much material for recycling as possible.
- Plastics enter a material recycling process and are not incinerated or sent to landfills.
- Batteries are removed and sent to battery recyclers for dedicated metals.

When the time comes for you to recycle, follow the easy steps outlined at [www.ysi.com](http://www.ysi.com).

## CONTACT INFORMATION

### ORDERING AND TECHNICAL SUPPORT

Telephone: 800 897 4151 (US)  
+1 937 767 7241 (Globally)  
Monday through Friday, 8:00 AM to 5:00 ET

Fax: +1 937 767 9353 (orders)  
+1 937 767 1058 (technical support)

Email: [environmental@ysi.com](mailto:environmental@ysi.com) or [proseries@ysi.com](mailto:proseries@ysi.com)

Mail: YSI Incorporated  
1725 Brannum Lane  
Yellow Springs, OH 45387 USA

Internet: [www.ysi.com](http://www.ysi.com)

When placing an order please have the following available:

- 1.) YSI account number (if available)
- 2.) Name and phone number
- 3.) Purchase Order or Credit Card
- 4.) Model Number or brief description
- 5.) Billing and shipping addresses
- 6.) Quantity

### SERVICE INFORMATION

YSI has authorized service centers throughout the United States and Internationally. For the nearest service center information, please visit [www.ysi.com](http://www.ysi.com) and click 'Support' or contact YSI Technical Support directly at 800-897-4151.

When returning a product for service, include the Product Return form with cleaning certification. The form must be completely filled out for a YSI Service Center to accept the instrument for service. The form may be downloaded from [www.ysi.com](http://www.ysi.com) by clicking on the 'Support' tab, then the Product Return Form button.

## APPENDIX A-DO% CALIBRATION VALUES

Calibration Value	Pressure			
D.O. %	in Hg	mmHg	kPa	mbar
101%	30.22	767.6	102.34	1023.38
100%	29.92	760.0	101.33	1013.25
99%	29.62	752.4	100.31	1003.12
98%	29.32	744.8	99.30	992.99
97%	29.02	737.2	98.29	982.85
96%	28.72	729.6	97.27	972.72
95%	28.43	722.0	96.26	962.59
94%	28.13	714.4	95.25	952.46
93%	27.83	706.8	94.23	942.32
92%	27.53	699.2	93.22	932.19
91%	27.23	691.6	92.21	922.06
90%	26.93	684.0	91.19	911.93
89%	26.63	676.4	90.18	901.79
88%	26.33	668.8	89.17	891.66
87%	26.03	661.2	88.15	881.53
86%	25.73	653.6	87.14	871.40
85%	25.43	646.0	86.13	861.26
84%	25.13	638.4	85.11	851.13
83%	24.83	630.8	84.10	841.00
82%	24.54	623.2	83.09	830.87
81%	24.24	615.6	82.07	820.73
80%	23.94	608.0	81.06	810.60
79%	23.64	600.4	80.05	800.47
78%	23.34	592.8	79.03	790.34
77%	23.04	585.2	78.02	780.20
76%	22.74	577.6	77.01	770.07
75%	22.44	570.0	75.99	759.94
74%	22.14	562.4	74.98	749.81
73%	21.84	554.8	73.97	739.67
72%	21.54	547.2	72.95	729.54

---

THIS PAGE LEFT INTENTIONALLY BLANK

---

# APPENDIX B - OXYGEN SOLUBILITY TABLE

Solubility of Oxygen in mg/L in Water Exposed to Water-Saturated Air at 760 mm Hg Pressure.

Salinity = Measure of quantity of dissolved salts in water.

Chlorinity = Measure of chloride content, by mass, of water.

$S(0/00) = 1.80655 \times \text{Chlorinity } (0/00)$

Temp °C	Chlorinity : 0 Salinity: 0	5.0 ppt 9.0 ppt	10.0 ppt 18.1 ppt	15.0 ppt 27.1 ppt	20.0 ppt 36.1 ppt	25.0 ppt 45.2 ppt
0.0	14.62	13.73	12.89	12.10	11.36	10.66
1.0	14.22	13.36	12.55	11.78	11.07	10.39
2.0	13.83	13.00	12.22	11.48	10.79	10.14
3.0	13.46	12.66	11.91	11.20	10.53	9.90
4.0	13.11	12.34	11.61	10.92	10.27	9.66
5.0	12.77	12.02	11.32	10.66	10.03	9.44
6.0	12.45	11.73	11.05	10.40	9.80	9.23
7.0	12.14	11.44	10.78	10.16	9.58	9.02
8.0	11.84	11.17	10.53	9.93	9.36	8.83
9.0	11.56	10.91	10.29	9.71	9.16	8.64
10.0	11.29	10.66	10.06	9.49	8.96	8.45
11.0	11.03	10.42	9.84	9.29	8.77	8.28
12.0	10.78	10.18	9.62	9.09	8.59	8.11
13.0	10.54	9.96	9.42	8.90	8.41	7.95
14.0	10.31	9.75	9.22	8.72	8.24	7.79
15.0	10.08	9.54	9.03	8.54	8.08	7.64
16.0	9.87	9.34	8.84	8.37	7.92	7.50
17.0	9.67	9.15	8.67	8.21	7.77	7.36
18.0	9.47	8.97	8.50	8.05	7.62	7.22
19.0	9.28	8.79	8.33	7.90	7.48	7.09
20.0	9.09	8.62	8.17	7.75	7.35	6.96
21.0	8.92	8.46	8.02	7.61	7.21	6.84
22.0	8.74	8.30	7.87	7.47	7.09	6.72
23.0	8.58	8.14	7.73	7.34	6.96	6.61
24.0	8.42	7.99	7.59	7.21	6.84	6.50

Temp °C	Chlorinity : 0 Salinity: 0	5.0 ppt 9.0 ppt	10.0 ppt 18.1 ppt	15.0 ppt 27.1 ppt	20.0 ppt 36.1 ppt	25.0 ppt 45.2 ppt
25.0	8.26	7.85	7.46	7.08	6.72	6.39
26.0	8.11	7.71	7.33	6.96	6.62	6.28
27.0	7.97	7.58	7.20	6.85	6.51	6.18
28.0	7.83	7.44	7.08	6.73	6.40	6.09
29.0	7.69	7.32	6.93	6.62	6.30	5.99
30.0	7.56	7.19	6.85	6.51	6.20	5.90
31.0	7.43	7.07	6.73	6.41	6.10	5.81
32.0	7.31	6.96	6.62	6.31	6.01	5.72
33.0	7.18	6.84	6.52	6.21	5.91	5.63
34.0	7.07	6.73	6.42	6.11	5.82	5.55
35.0	6.95	6.62	6.31	6.02	5.73	5.46
36.0	6.84	6.52	6.22	5.93	5.65	5.38
37.0	6.73	6.42	6.12	5.84	5.56	5.31
38.0	6.62	6.32	6.03	5.75	5.48	5.23
39.0	6.52	6.22	5.98	5.66	5.40	5.15
40.0	6.41	6.12	5.84	5.58	5.32	5.08
41.0	6.31	6.03	5.75	5.49	5.24	5.01
42.0	6.21	5.93	5.67	5.41	5.17	4.93
43.0	6.12	5.84	5.58	5.33	5.09	4.86
44.0	6.02	5.75	5.50	5.25	5.02	4.79
45.0	5.93	5.67	5.41	5.17	4.94	4.72

Item # 626279  
Rev C  
Drawing # A626279  
March 2009

©2009 YSI Incorporated.



**STANDARD OPERATING PROCEDURE**  
**MAINE VOLUNTEER RIVER MONITORING PROGRAM**  
**METHODS FOR USING THE YSI Pro2030**  
**HANDHELD METER IN RIVERS AND STREAMS**



**Note:** The mention of brand names does not constitute recommendation of a specific company.



## Volunteer River Monitoring Program (VRMP)

### Standard Operating Procedure Methods for using the YSI Pro2030 Handheld Meter

**1. Applicability.** This standard operating procedure (SOP) is used by the Volunteer River Monitoring Program (VRMP) of the Maine Department of Environmental Protection's Division of Environmental Assessment. It applies to the collection of dissolved oxygen (DO), temperature, specific conductance, and salinity from rivers and streams in Maine using the YSI Pro2030 handheld meter.

**2. Purpose.** This purpose of this SOP is to provide standardized methods for volunteer groups to determine temperature, dissolved oxygen, specific conductance, TDS (Total Dissolved Solids), and salinity of rivers and streams by volunteers as an instantaneous reading using the YSI Pro 2030 handheld meter.

### 3. Definitions.

**A. YSI.** Yellow Springs International, manufacturer of water quality monitoring meters.

**B. Specific Conductance.** A measure of the ability of a water solution to conduct an electrical current. Specific conductance is electrical conductivity (EC) that is being expressed in microsiemens per centimeter ( $\mu\text{s}/\text{cm}$ ) at a normalized temperature of 25° C. Specific conductance is related to the type and concentration of ions in solution and can be used for approximating the dissolved-solids content of the water. Commonly, the concentration of dissolved solids (in mg/L) is about 65% of the specific conductance (in microsiemens). (*Note:* This relation is not constant from stream to stream, and it may vary in the same stream with changes in the composition of the water.)

**C. Salinity.** Salinity is a measure of the total amount of dissolved salts in a sample. Sodium and chloride are the predominant ions in seawater, and other substantial ions include magnesium, calcium and sulfates. Salinity is an important factor in determining many aspects of the chemistry of natural waters and biological processes. In marine waters, salinity affects dissolved oxygen and will need to be measured separately in order to accurately calibrate the meter, if the particular dissolved oxygen meter does not directly measure salinity. Salinity may be expressed in a number of ways, parts per thousand and parts per million are the two most common measurements, and it is sometimes expressed as a percentage as well.

**D. Probe.** Sensing device located at the end of a cable that is attached to the meter.

**E. Electrolyte solution.** Solution used to fill the probe.

**F. Calibration.** Set of procedures established by the manufacturer to ensure that the meter



- a. is operating properly; a critical quality assurance step in meter preparation prior to use.
- G. Membrane Cap.** A polyethylene cap on the on the end of the probe. The membrane is permeable and allows gases such as oxygen to pass through into probe sensors while at the same time isolating most other undesirable substances.
- H. Jigging.** To move the probe under water using steady movements. Unless the probe is being held in swiftly flowing water, the probe shall be moved (“jigged”) approximately 6 inches per second to overcome the inherent consumption of oxygen by the sensor.
- I. Total Dissolved Solids.** In stream water, dissolved solids consist of calcium, chlorides, nitrates, phosphorus, iron, sulfur, and other ion particles that will pass through a filter with pores of around 2 microns (0.002 cm) in size. TDS is calculated by converting the electrical conductivity by a factor of 0.5 to 1.0 times the EC.

#### 4. Responsibilities.

##### *A. Volunteer Monitors & Volunteer Groups*

- **Certification.** It is the responsibility of the individual obtaining this data to maintain current certification for the parameter(s) they collect if they wish their data to be entered into the VRMP database. Training will be provided to volunteers on an annual basis by VRMP/DEP staff, and certification will last for one year from the date of training.
- **Data Recording.** It is the responsibility of the individual obtaining this data to record the results and additional qualifying information on current field sheets obtained from their affiliated watershed association or through the VRMP program of the DEP.
- **Data Quality Checks and Data Submission.** The data manager for the volunteer group will collect and enter volunteer field sheet data onto the appropriate computer file, perform quality assurance checks (Refer to Section 5.10 of the Quality Assurance Program Plan), and submit data to the VRMP following protocols outlined in the volunteer group’s latest sampling and analysis plan (SAP) that has been approved by the VRMP.

##### *B. Volunteer River Monitoring Program (VRMP) Staff*

- **Oversight of Volunteer Groups and Volunteers.** VRMP staff will oversee volunteer groups and volunteers through a variety of ways including maintaining an up-to-date VRMP quality assurance program plan (QAPP); reviewing sampling and analysis plans (SAPs) of the volunteer groups; providing annual training/certification sessions for volunteers; conducting quality assurance checks on data submitted by





volunteer groups and laboratories; and uploading data into the DEP's EGAD database. These tasks are described in greater detail in the VRMP's latest QAPP.

## 5. Guidelines and procedures.

### A. YSI Pro2030 Meter Preparation.

- **First time use.** Follow manufacturer's instructions for preparing meter for first time use. (Refer to Appendix A: [Connecting the Sensor and Cable] and [Navigation – First Power On]).
- **Beginning of field season.** Before each field season, VRMP shall conduct a full inspection of the meter. If membrane has been stored dry, follow manufacturer's instructions for (refer to Appendix A: Sensor Maintenance-Dissolved Oxygen). A new membrane cap and batteries shall be installed prior to the start of field sampling and additionally, as needed (refer to Appendix A). VRMP staff will check meter against "benchmark" DO meter accuracy. In addition, each meter "setup" should be equipped with the following items so that field repairs can be undertaken as necessary:
  - Extra electrolyte solution and membrane caps for probe
  - Extra batteries
  - Field data sheet
  - Screwdriver for removing back of meter to replace batteries
  - Distilled Water (to clean the conductivity cell)
  - Pencil with eraser
- **Prior to field sampling.** Before each field sample collection, the volunteer should inspect the meter including an inspection of the condition of the probe membrane, membrane cap, and batteries.
  - (1) Check the membrane cap for air bubbles and look for significant deposits of dried electrolyte on the membrane. If bubbles are present, remove membrane, refill with electrolyte solution, and replace membrane cap.
  - (2) Check to make sure drops of water are not clinging to the membrane. If drops are present, blow on membrane to gently remove droplets. Don't tap; these probes are very fragile. The sponge in the grey calibration/storage sleeve should be moist. It should not have excess water on it that could cause water droplets to get on the membrane.
  - (3) Batteries should be checked for charge and/or expiration.
  - (4) Be familiar with the testing, inspection, maintenance, and calibration considerations described in sections 5.6 through 5.8 of the VRMP QAPP (MDEP, 2014).
  - (5) Power on the meter and allow sufficient warm-up time (5-15 min) prior to initial use for the day.



- **Specific Conductance Calibration.** VRMP should conduct a system calibration check according to manufacturer’s instructions and make adjustments. (Refer to Appendix A: [Conductivity Calibration].)
- **Dissolved Oxygen Calibration.** If collecting dissolved oxygen measurements, the YSI Pro2030 meter shall be calibrated each time the unit is turned on. Meters shall be calibrated to a 100% water-saturated air environment (for instructions, refer to Appendix A: Calibrating in Percent (DO%)).  
**NOTE:** [Do Local% and Quick DO Cal are disabled in the System]
- **Dissolved Oxygen Check Against “Zero Dissolved Oxygen” Standard.** VRMP staff shall check DO meters using zero oxygen standard at the beginning and end of the field season. Volunteers shall check their DO meter using zero oxygen solution in mid-season. The zero oxygen solution is provided by VRMP/DEP staff. Volunteers shall record the dissolved oxygen value they measure with their meter in the appropriate blank on the field data sheet. (See section 5-B of this SOP for instructions on how to make measurements with the YSI Pro2030 meter.)

***B. Dissolved Oxygen/Temperature/Specific Conductance/TDS/Salinity Measurements.***

- **Sampling Period and Site Location.** Sampling period and site location information will be documented in the volunteer groups’ SAPs (that require approval by the VRMP) which are submitted by the volunteer groups prior to any sampling. (Detailed information regarding how volunteer groups are to obtain and document site location information can be found in VRMP SOP-02 [Documenting Site Location].)
- **Sample Timing.** Dissolved oxygen data collected between dawn and 8 am are important for assessment of attainment of DO criteria within Maine’s Water Quality Standards. But, except as naturally occurs, DO concentrations below the applicable DO criteria at any time of day signal non-attainment. If there are no DO concentrations below the criteria after 8 am, then data between dawn and 8 am must be collected to assess attainment of the criteria.
- **Familiarize Yourself with the Meter.** Familiarize yourself with the basic operation, keypad, and readouts of the meter (Appendix A: Navigation, Calibration and Taking Measurements).
- **General Sampling Protocol.**
  - Record site location on data sheet.
  - Remove probe from calibration chamber.
  - Submerge probe in the water at the site where you are monitoring, as described in your group’s approved SAP.
  - For any parameter (DO, specific conductance, temperature, salinity, TDS), allow the reading to stabilize (at least 8 seconds) before recording the value on the field sheet.



- Follow the instructions below for measuring specific parameters.
- The meter should remain turned on between stations, unless time between samplings exceeds 30-60 minutes. If meter is turned off, the field probe should be stored inside the calibration chamber during transport, sufficient time (5-15 min) should be allowed for warm-up, and the meter should be re-calibrated.

- **Dissolved Oxygen Measurements.**

(1) Review and follow the instructions for making DO measurements (Appendix A: Taking Measurements). Make sure units are taken in mg/L (or ppm).

(2) *Note of caution:* Unless the probe is equipped with a stirrer, jiggling of the probe is extremely important for obtaining accurate dissolved oxygen readings, unless you have placed the probe in a swiftly-moving section of stream or river. (The probe is dependent on the amount of oxygen that passes across the membrane, and the probe actually consumes oxygen as it is making measurements.) An up-and-down motion (jiggling) creating movement of 6 inches per second is recommended. If placing the probe in a stream or fast moving waters, it is best to place it perpendicular to the flow and not facing into the flow.

- **Specific Conductance, TDS and Salinity Measurements.**

(1) There are seven options for displaying conductivity to include Cond-mS/cm, Cond-uS/cm, SPC-mS/cm, SPC-uS/cm, Salinity-ppt, TDS-g/l and TDS-mg/l. Only two units can be enabled at the same time. Specific conductivity-uS/cm and Salinity are enabled. If other units are required see (Appendix A: Conductivity Units) for how to change.

- **Quality Control.**

(1) At the beginning of each field season, all VRMP staff and VRMP volunteers who collect dissolved oxygen, temperature, specific conductance, and salinity data will have a training/refreshers/certification session to (re)familiarize themselves with the contents of this SOP.

(2) For every volunteer, a field duplicate shall be obtained for all parameters for at least 10% of their own sampling efforts. A field duplicate will be collected for every 10 samples monitored.

(3) Refer to the VRMP quality assurance project plan (QAPP) for more QA/QC details.

## 6. Equipment Care.

### A. *Start of field season.*

1. Follow manufacturer's directions for preparation of a new probe or renewing probe in the spring (refer to (Appendix A: Sensor Maintenance). Replace membrane cap at the start of each sampling season.
2. Use new batteries at start of each sampling season. An extra set of appropriate size batteries should be included in the meter carrying case.



3. If needed, clean the probe (anode and cathode) according to manual directions.
4. Each D.O. meter should have the following items for making repairs in the field. See section 5-A of this SOP for a list of items.

***B. Field Season***

1. Ideally the meter should be in water-resistant case with padding to protect it from damage.
2. Keep the calibration/storage sleeve over the probe guard. Be sure to keep a small amount of moisture (clean tap water) on the sponge in the sleeve during storage. The sensors should not be submerged.
3. Allow the case and contents to air-dry at the end of each day. This may be accomplished by simply propping the lid open. When contents are very wet, remove the contents and spread out to facilitate drying.
4. Keep meter from freezing.
5. Refer to Appendix A: Trouble Shooting for specific problems.

***C. End of field season***

1. Completely dry meter, case, and all items in the case before storing.
2. Remove batteries.
3. Remove membrane cap, rinse and dry.
4. Rinse entire probe and calibration chamber with distilled water. Allow to air dry completely.
5. Follow manufacturer’s instructions for cleaning the conductivity electrodes.
6. Put membrane cap back on to keep dust and dirt out for winter.
7. Keep meter dry and at room temperature to prevent corrosion of electronic parts.
8. Review Appendix A: Warranty and Service Information for more tips.
9. Record winterization date and equipment repairs in your volunteer group’s Equipment Log.
10. Label the meter and case as ‘WINTERIZED’ in an obvious manner (so users will know the current status of the unit).

**7. Specifications**

<b>Parameter</b>	<b>Range</b>	<b>Resolution</b>	<b>Accuracy</b>
Temperature	-5 to 55°C	0.1°C	± 0.3°C
Dissolved Oxygen	0 to 200% air saturation	1% or 0.1%, user selectable	± 2% of the reading or ±2% air saturation, whichever is greater
	0 to 20 mg/l	0.1 or 0.01 mg/l, user selectable	±2% of the reading or ± 0.2 mg/L, whichever is greater
Conductivity	0 – 500 µS/cm 0-5 mS/cm 0-50 mS/cm 0-200 mS/cm (auto ranging)	0.0001 to 0.1 mS/cm; 0.1 to 0 µS/cm (range dependent)	Instrument with 10, 20 or 30 meter cable: ± 2% of the reading or 1 µS/cm, whichever is greater.



Salinity	0 to 70 ppt	0.1 ppt	± 1.0% of the reading or ± 0.1 ppt, whichever is greater.
Total Dissolved Solids (TDS)	0 to 100 g/L. TDS Constant range: 0.3 to 1.00 (0.65 default)	0.0001 to 0.1 g/L (range dependent)	Dependent on accuracy of temperature, conductivity and TDS Constant
Air Pressure	500.0 to 800.0 mmHg	0.1 mmHg	±5 mmHg within 15°C of calibration temperature

## 8. Appendix

### A. YSI Meter owner's manual:

YSI Incorporated. 2010. YSI Model Pro2030 User Manual. Yellow Springs, Ohio.

## 9. References

### A. DEP Standard Operating Procedures:

- Document number #:DEP-LW0890: Dissolved Oxygen and Temperature, Instantaneous Measurement using Electronic Meters
- Document number #: DEPLW0636: Protocols for using Hanna Dissolved Oxygen and Specific Conductance/Temperature/pH Meters

### B. Maine VRMP QAPP:

- Maine Department of Environmental Protection (MDEP). 2020. Maine Volunteer River Monitoring Program (VRMP) Quality Assurance Program Plan (VRMP). Document number #:DEPLW-0984.



# Pro2030



## USER MANUAL

English

# CONTENTS

---

Warranty .....	i
Introduction .....	1
Getting Started .....	1
Initial Inspection .....	1
Battery Installation .....	1
Key Pad .....	2
Connecting the Sensor and Cable .....	3
Membrane Installation .....	5
Run Screen .....	6
Backlight .....	7
Powering Off .....	7
Navigation .....	7
First Power On .....	8
System Setup Menu .....	8
DO Local% .....	9
Last Digit Suppression (LDS) .....	10
Quick DO Calibration (Quick DO Cal) .....	10
Audio .....	11
Contrast .....	11
Sensor Type .....	11
Membrane Type .....	12
Auto Stable .....	13
DO Units .....	14
Conductivity Units (Cond. Units) .....	14
Specific Conductance Reference Temperature (SPC Ref. Temp.) .....	15
Specific Conductance Temperature Coefficient (SPC %/°C) .....	16
TDS Constant .....	16
Temperature Units .....	17
Pressure Units .....	17

Item #605056  
Rev C  
Drawing # A605056  
November 2010

©2010 YSI Incorporated.

The YSI logo is a registered trademarks of YSI Incorporated.  
Teflon is a registered trademark of E. I. du Pont de Nemours and Company.

Language .....	17
Auto Shutoff .....	17
Resetting the System Setup Menu to Factory Default.....	18
Calibration .....	19
Temperature.....	19
Barometer .....	19
Dissolved Oxygen .....	19
Conductivity Calibration .....	22
Taking Measurements.....	25
Saving and Viewing Data .....	25
Saving Data.....	25
Viewing and Erasing Saved Data - Data Mode.....	26
Care, Maintenance and Storage .....	29
General Maintenance .....	29
Sensor Maintenance.....	30
Sensor Storage .....	35
Troubleshooting .....	36
Specifications.....	39
Accessories / Part Numbers .....	40
Declaration of Conformity.....	41
Recycling.....	42
Battery Disposal .....	42
Contact Information.....	43
Ordering and Technical Support.....	43
Service Information .....	43
Appendix A-DO% Calibration Values .....	44
Appendix B-Oxygen Solubility Table .....	45

## WARRANTY

---

The YSI Professional 2030 instrument (Pro2030) is warranted for three (3) years from date of purchase by the end user against defects in materials and workmanship, exclusive of batteries and any damage caused by defective batteries. Pro2030 cable assemblies are warranted for two (2) years from date of purchase by the end user against defects in material and workmanship. Pro2030 Polarographic sensors are warranted for one (1) year and Galvanic sensors are warranted for six (6) months from date of purchase by the end user against defects in material and workmanship. Pro2030 instruments, cables & sensors are warranted for 90 days from date of purchase by the end user against defects in material and workmanship when purchased by rental agencies for rental purposes. Within the warranty period, YSI will repair or replace, at its sole discretion, free of charge, any product that YSI determines to be covered by this warranty.

To exercise this warranty, call your local YSI representative, or contact YSI Customer Service in Yellow Springs, Ohio at +1 937 767-7241, 800-897-4151 or visit [www.YSI.com](http://www.YSI.com) for a Product Return Form. Send the product and proof of purchase, transportation prepaid, to the Authorized Service Center selected by YSI. Repair or replacement will be made and the product returned, transportation prepaid. Repaired or replaced products are warranted for the balance of the original warranty period, or at least 90 days from date of repair or replacement.

### LIMITATION OF WARRANTY

This Warranty does not apply to any YSI product damage or failure caused by:

1. Failure to install, operate or use the product in accordance with YSI's written instructions;
2. Abuse or misuse of the product;
3. Failure to maintain the product in accordance with YSI's written instructions or standard industry procedure;
4. Any improper repairs to the product;
5. Use by you of defective or improper components or parts in servicing or repairing the product;
6. Modification of the product in any way not expressly authorized by YSI.

THIS WARRANTY IS IN LIEU OF ALL OTHER WARRANTIES, EXPRESSED OR IMPLIED, INCLUDING ANY WARRANTY OF MERCHANTABILITY OR FITNESS FOR A PARTICULAR PURPOSE. YSI'S LIABILITY UNDER THIS WARRANTY IS LIMITED TO REPAIR OR REPLACEMENT OF THE PRODUCT, AND THIS SHALL BE YOUR SOLE AND EXCLUSIVE REMEDY FOR ANY DEFECTIVE PRODUCT COVERED BY THIS WARRANTY. IN NO EVENT SHALL YSI BE LIABLE FOR ANY SPECIAL, INDIRECT, INCIDENTAL OR CONSEQUENTIAL DAMAGES RESULTING FROM ANY DEFECTIVE PRODUCT COVERED BY THIS WARRANTY.



---

THIS PAGE LEFT INTENTIONALLY BLANK

---

## INTRODUCTION

---

Thank you for purchasing the YSI Pro2030, an instrument from the YSI *Professional Series* product family. The Pro2030 measures dissolved oxygen, conductivity and temperature in water. The Pro2030 features an impact resistant and waterproof (IP-67) case, a rugged MS-8 (military-spec) cable connector, backlit display, user-selectable sensor options, 50 data set memory, internal barometer and a rubber over-mold case.

The Pro2030 provides valuable instructions and prompts near the bottom of the display that will guide you through operation and use. However, reading the entire manual is recommended for a better understanding of the instrument's features.



*The Pro2030 cannot communicate to a PC via a Pro Series communications saddle. Connecting the Pro2030 to a communication saddle may cause erratic instrument behavior.*

## GETTING STARTED

---


### INITIAL INSPECTION

---

Carefully unpack the instrument and accessories and inspect for damage. Compare received parts with items on the packing list. If any parts or materials are damaged or missing, contact YSI Customer Service at 800-897-4151 (+1 937 767-7241) or the authorized YSI distributor from whom the instrument was purchased.

### BATTERY INSTALLATION

---

The instrument requires 2 alkaline C-cell batteries. Under normal conditions, the average battery life is 425 hours at room temperature without using the back light. A battery symbol  will blink in the lower, left corner of the display to indicate low batteries when approximately 1 hour of battery life remains.

To install or replace the batteries:

1. Turn the instrument off and flip over to view the battery cover on the back.
2. Unscrew the four captive battery cover screws.
3. Remove the battery cover and remove the old batteries if necessary.
4. Install the new batteries, ensuring correct polarity alignment (figure 1).

- Place the battery cover on the back of the instrument and tighten the four screws. Do not over-tighten.

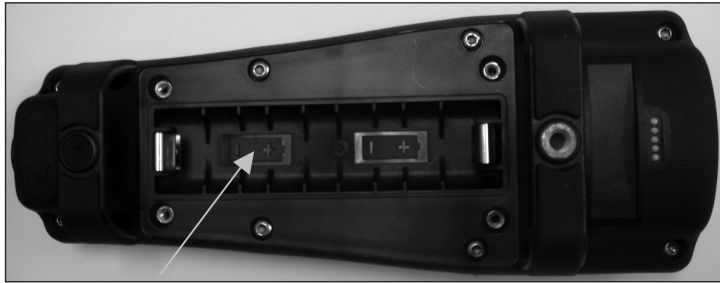


Figure 1. Pro2030 with battery cover removed. Notice battery symbols indicating polarities.

**i** The waterproof instrument case is sealed at the factory and is not to be opened, except by authorized service technicians. Do not attempt to separate the two halves of the instrument case as this may damage the instrument, break the waterproof seal, and will void the warranty.

## KEY PAD

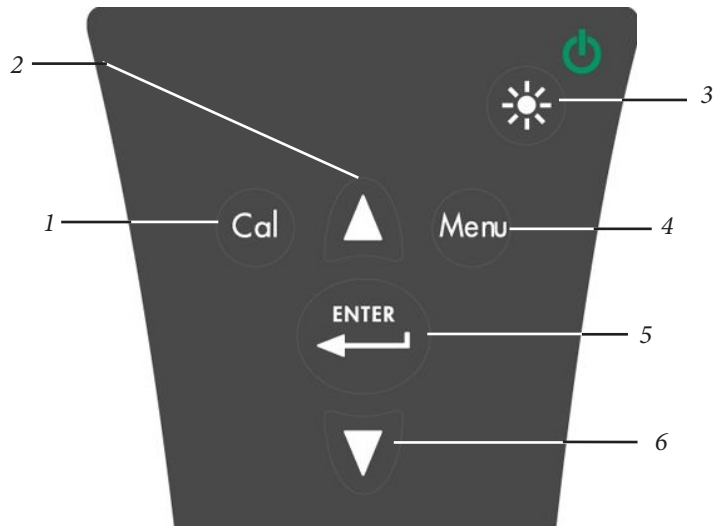


Figure 2, Keypad

Number	Key	Description
1		<b>Calibrate</b> Press and hold for 3 seconds to calibrate. Opens Calibrate menu from the Run screen.
2		<b>Up Arrow</b> Use to navigate through menus, to navigate through box options along the bottom of the Run screen and to increase numerical inputs.
3		<b>Power and Backlight</b> Press once to turn instrument on. Press a second time to turn backlight on. Press a third time to turn backlight off. Press and hold for 3 seconds to turn instrument off.
4		<b>Menu</b> Use to enter the System Setup menu from the Run screen.
5		<b>Enter</b> Press to confirm entries and selections.
6		<b>Down Arrow</b> Use to navigate through menus, to navigate through box options at the bottom of the Run screen and to decrease numerical inputs.

## CONNECTING THE SENSOR AND CABLE

“Bulkhead” refers to the single-pin connector at the end of the probe/cable assembly where the dissolved oxygen (DO) sensor is installed (figure 3). The conductivity and temperature sensors are located above and next to the bulkhead respectively and are not user-replaceable.

**i** When a dissolved oxygen sensor is not installed in the cable, the sensor and cable's bulkhead connectors are not water-proof. Do not submerge the cable without a sensor installed. Submerging the cable without a sensor installed may cause permanent damage to the cable that is not covered under warranty.

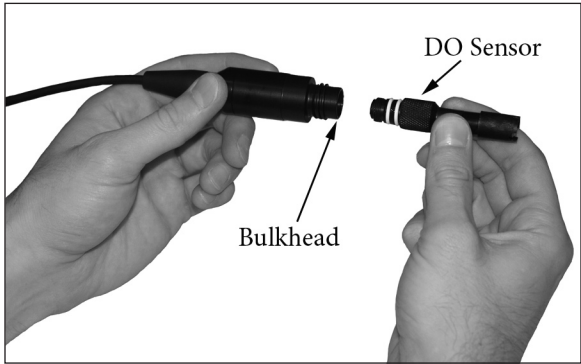


Figure 3

## INSTALLING THE DISSOLVED OXYGEN SENSOR

The Pro2030 has two compatible dissolved oxygen sensors:

**Polarographic** – This sensor has a black sensor body and is engraved with the model number 2003. Polarographic will be abbreviated Polaro in the instrument's menu.

**Galvanic** – This sensor has a grey sensor body and is engraved with the model number 2002.

For information on the differences between these two types of sensors, see Sensor Type in the System Setup Menu section of this manual.



*Before installing either sensor or connecting the cable to the instrument, the Sensor Type must be configured for the sensor being installed/connected. Failure to do this may result in damage not covered under warranty. The instrument will step you through this setup the first time the instrument is powered on. See the System Setup Menu section of this manual for instructions on configuring the Sensor Type after the first power on.*

1. Remove the red plastic plug from the cable's bulkhead port by pulling it straight out of the port. This can be discarded.
2. Remove the red plastic plug from the sensor's connector by pulling it straight off the sensor. This can be discarded.
3. Ensure both the sensor connector and bulkhead connector on the cable are clean and dry.
4. Grasp the sensor with one hand and the cable bulkhead in the other.

5. Push the sensor into the connector on the cable until it is firmly seated and only 1 o-ring is visible. Failure to properly seat the sensor may result in damage.
6. Twist the sensor clockwise to engage the threads and finger tighten. Do NOT use a tool. This connection is water-tight.

For more detailed instructions, please refer to the sensor installation sheet that is included with each sensor.

## CONNECTING THE PROBE/CABLE ASSEMBLY TO THE INSTRUMENT

To connect the cable, align the keys on the cable connector to the slots on the instrument connector. Push together firmly and then twist the outer ring until it locks into place (figure 4). This connection is water-proof.



Figure 4, Note the keyed connector.

## MEMBRANE INSTALLATION


The sensing end of the dissolved oxygen sensor is shipped with a protective red cap that needs to be removed before using. Additionally, it is very important to install a new membrane with electrolyte solution onto the sensor after removing the red cap.

Prepare the electrolyte solution according to the instructions on the bottle. After mixing, allow the solution to sit for 1 hour. This will help prevent air bubbles from later developing under the membrane. Ensure you are using the correct electrolyte solution for your sensor. Galvanic sensors utilize electrolyte with a

light blue label on the bottle and Polarographic sensors utilize electrolyte with a white label on the bottle. The dissolved oxygen sensor is supplied with cap membranes specific to the sensor type ordered (Polarographic or Galvanic). 5913 and 5914 membrane kits are for Galvanic sensors and the 5908 and 5909 membrane kits are for Polarographic sensors.

Remove and discard or save the red protective cap from the dissolved oxygen sensor by pulling it straight off. Thoroughly rinse the sensor tip with distilled or deionized water. Fill the cap membrane 3/4 full of electrolyte solution, then tap the cap with a finger to release any trapped air. Be careful not to touch the membrane portion of the cap. Thread the membrane cap onto the sensor, moderately tight. Do not use a tool. It's typical for some of the electrolyte solution to spill over. It is best to allow the new cap to remain on the sensor overnight before calibrating. For detailed instructions on changing a cap membrane, see the Care, Maintenance and Storage section of this manual.

## RUN SCREEN

Press the power/backlight key  to turn the instrument on. The instrument will run through a self test and briefly display a splash screen with system information before displaying the main Run screen (figure 5). The first time the Pro2030 is turned on, it will step through language, sensor and membrane selections; see the First Power On section of this manual for more information.

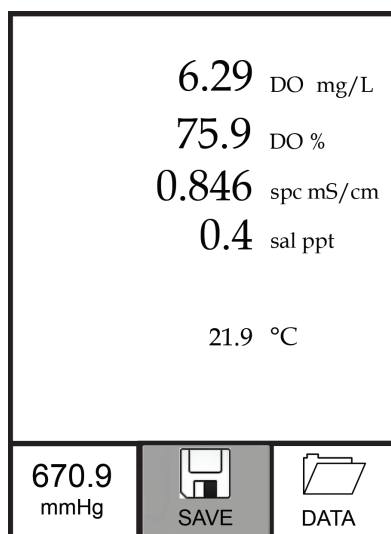




Figure 5, Run screen.

## BACKLIGHT

Once the instrument is powered on, pressing the power/backlight key  will turn on the display backlight. The backlight will remain on until the key is pressed again or after two minutes of not pressing any key on the keypad.



## POWERING OFF

To turn the instrument off, press and hold the power/backlight key  for three seconds.



## NAVIGATION

The up  and down  arrow keys allow you to navigate through the functions of the Pro2030.

### NAVIGATING THE RUN SCREEN

When in the Run screen, the up  and down  arrow keys will move the highlighted box along the bottom options. Once a box is highlighted, press enter to access the highlighted option.

Description of Run screen box functions from left to right:

Option	Description
Barometer reading	Highlight and press enter to calibrate the barometer.
 SAVE	Highlight and press enter to save displayed data to memory.
 DATA	Highlight and press enter to view and/or erase saved data.

### NAVIGATING THE SYSTEM SETUP MENU

When in the System Setup menu, the up and down arrow keys will move the highlighted bar up and down the system setup options. See the System Setup menu section of this manual for more information about these options.

## FIRST POWER ON


The instrument will step through an initial configuration when powered on for the first time. This will set the language, dissolved oxygen sensor type and membrane type. Use the up or down arrow keys to highlight the appropriate language, sensor and membrane, then press enter to confirm (figures 6). The Sensor Type must be configured for the dissolved oxygen sensor installed on the cable. Failure to do this may result in damage not covered under warranty. If an incorrect option is selected, it may be changed in the System Setup menu.

<p>Select Language:</p> <p><input checked="" type="checkbox"/> English <input type="checkbox"/> Français <input type="checkbox"/> Español <input type="checkbox"/> Deutsch</p> <p>Use ▲▼ to select Language Press ↵ to confirm</p>	<p>Select Sensor Type:</p> <p><input checked="" type="checkbox"/> Polaro (black) <input type="checkbox"/> Galvanic (grey)</p> <p>Use ▲▼ to select sensor type Press ↵ to confirm</p>	<p>Select Membrane Type:</p> <p><input checked="" type="checkbox"/> 1.25 (Yellow) <input type="checkbox"/> 2.0 (Blue)</p> <p>Use ▲▼ to select membrane Press ↵ to confirm</p>
--	--	---

Figure 6, Select language, dissolved oxygen sensor and membrane.

After selecting a language, sensor and membrane, the Run screen will be displayed. The next time the instrument is powered up, the Run screen will display immediately after the splash screen. If the sensor type or membrane type is changed, ensure that it is updated in the System Setup menu.

## SYSTEM SETUP MENU


Press the menu  key to access the System Setup menu. The System Setup menu contains multiple screens that are notated as 'pages'. The current page is indicated near the bottom of the display (figure 7).

Use the up and down arrow keys to scroll through menu options and menu pages.

### EXITING THE SYSTEM SETUP MENU

To exit the System Setup menu, press the down arrow key until the ESC - Exit box is highlighted, then press enter to return to the Run screen.

## DO LOCAL%

DO Local% can be enabled or disabled by using the up or down arrow keys to highlight it and then pressing enter . An 'X' in the box next to DO Local% indicates it is enabled (Figure 7).


<p><input checked="" type="checkbox"/> DO Local%</p> <p><input type="checkbox"/> LDS</p> <p><input type="checkbox"/> Quick DO Cal</p> <p><input type="checkbox"/> Audio</p> <p>Contrast</p> <p>Sensor Type</p> <p>Membrane Type</p> <p>Page 1 of 3</p>	<p>ESC Exit</p>	<p> Reset</p>	
--	---------------------	--	--

Figure 7, page 1 of System Setup menu. DO Local% is enabled.

When DO Local% is enabled, DO% values will be expressed as %L on the Run screen.

DO Local% allows for localized % saturation measurements, but does not affect the mg/L readings. When enabled, the DO% calibration value is always 100% regardless of the altitude or barometric pressure of the location. This deviates from YSI's traditional method of expressing DO% saturation where the % calibration value decreases with a decrease in barometric pressure, i.e. an increase in altitude (Appendix A). To determine the % calibration value when DO Local% is disabled, divide the local barometric pressure pressure in mmHg by 760 and then multiply by 100.

Example:  $750/760 = 0.9868 \times 100 = 98.68\%$  calibration value when DO Local is disabled.

When DO Local% is enabled, the Pro2030 corrects for barometric pressure on each DO measurement instead of during calibration.

Example:

Instrument #1 with DO Local% enabled:

At 737 mmHg barometric pressure, roughly 841 ft above sea level, the instrument would calibrate to 100%.

When taking measurements at the same location (737 mmHg) in a 20°C fresh water sample that is completely air-saturated, the instrument would read:

DO %L value = 100%

DO mg/L value = 8.81 mg/L ( $9.09^1 \times .9697^2$ )

Instrument #2 DO Local% disabled:

At 737 mmHg barometric pressure, roughly 841 ft above sea level, the instrument would calibrate to  $737/760 \times 100\% = 96.97\%$

When taking measurements at the same location (737 mmHg) in a 20°C fresh water sample that is completely air-saturated, the instrument would read:


DO% value = 96.97%

DO mg/L value = 8.81 mg/L ( $9.09^1 \times .9697^2$ )

Hence, the mg/L readings are unaffected by DO Local%.

- 1.) Value from oxygen solubility table (Appendix B).
- 2.)  $737/760 \times 100\%$ , correction for barometric pressure.


## **LAST DIGIT SUPPRESSION (LDS)**

Last Digit Suppression (LDS) can be enabled or disabled by using the up or down arrow keys to highlight it and pressing enter . An 'X' in the box next to LDS indicates it is enabled.

LDS rounds the DO value to the nearest tenth; i.e. 8.25 mg/L becomes 8.3 mg/L. LDS is automatically disabled during calibrations.

## **QUICK DO CALIBRATION (QUICK DO CAL)**

Quick DO Cal can be enabled or disabled by using the up or down arrow keys to highlight Quick DO Cal and pressing enter. An 'X' in the box next to Quick DO Cal indicates it is enabled.

When Quick DO Cal is enabled, press and hold the calibration  key for 3 seconds while in the Run screen. Next, highlight Dissolved Oxygen and press enter to calibrate the DO sensor to the instrument's barometer reading. For more information on Quick DO Cal, see the Calibration section of this manual.

## **AUDIO**

Audio can be enabled or disabled by using the up or down arrow keys to highlight Audio and pressing enter. When enabled, there will be an 'X' in the box next to Audio.

When Audio is enabled, the Pro2030 will beep twice to indicate stability when Auto Stable is enabled. The instrument will also beep when a key is pressed. When Audio is disabled, the Pro2030 will not beep.

## **CONTRAST**

To adjust the display Contrast, use the up or down arrow keys to highlight Contrast, then press enter. Next, use the up or down arrow keys to adjust the contrast. The up arrow key will darken the contrast and the down arrow key will lighten the contrast. After adjusting the contrast, press enter to save and exit the Contrast adjustment option.

### **EMERGENCY CONTRAST ADJUSTMENT**

If necessary, there is an alternate method of adjusting the contrast. To adjust the contrast, press and hold the menu key, then press the up arrow key to darken the contrast or press the down arrow key to lighten the contrast.

## **SENSOR TYPE**

Sensor Type sets the type of dissolved oxygen sensor being used; either Polarographic (black) or Galvanic (grey).



*The instrument's Sensor Type must be configured for the sensor installed. Failure to do this may result in damage not covered under warranty. If you observe readings very close to 0 or extremely high readings, i.e. 600%, the Sensor Type setting may be incorrect.*

Use the up or down arrow keys to highlight Sensor Type, then press enter to open a submenu. Highlight the sensor type corresponding to the sensor installed on the cable and press enter to confirm. The enabled sensor type will have an 'X' in the box next to it. Next, use the down arrow key to highlight the ESC – Exit, then press enter to save changes and to close the sensor submenu.

The Pro2030 has two compatible sensors for use with a field cable:

**Polarographic** – This sensor has a black sensor body and is engraved with the model number 2003. Polarographic will be abbreviated Polaro in the instrument.

**Galvanic** – This sensor has a grey sensor body and is engraved with the model number 2002.

In terms of physical configuration, membrane material and general performance, YSI Professional Series Galvanic dissolved oxygen sensors are exactly like the Professional Series Polarographic sensors. The advantage of using Galvanic sensors is convenience. Galvanic sensors provide an instant-on sensor without the need for warm-up time but this affects the life of the sensor. Polarographic sensors last longer and have a longer warranty but require a 5-15 minute warm-up time before use or calibration.

## MEMBRANE TYPE

Membrane Type sets the type of membrane used on the dissolved oxygen sensor; either 1.25 PE (Yellow) or 2.0 PE (blue). Use the up or down arrow keys to highlight Membrane Type and press enter to open the membrane submenu. Highlight the membrane type corresponding to the membrane installed on the sensor and press enter to confirm. The enabled membrane type will have an 'X' in the box next to it. Use the down arrow key to highlight the ESC – Exit box along the bottom of the display and press enter to save changes and to close the membrane submenu.

The dissolved oxygen sensor is supplied with membranes specific to the sensor type and are color coded as described in the following tables.

### Galvanic Membrane Kits:

<i>Item</i>	<i>Color</i>	<i>Material</i>	<i>Description</i>
5913	Yellow	1.25 mil polyethylene (PE)	Faster response time and less flow dependence than traditional Teflon® membranes.
5914	Blue	2.0 mil polyethylene (PE)	Less flow dependence than 1.25 mil membrane but somewhat slower response.

### Polarographic Membrane Kits:

<i>Item</i>	<i>Color</i>	<i>Material</i>	<i>Description</i>
5908	Yellow	1.25 mil polyethylene (PE)	Faster response time and less flow dependence than traditional Teflon® membranes.
5909	Blue	2.0 mil polyethylene (PE)	Less flow dependence than 1.25 mil membrane but somewhat slower response.

### Selecting a Dissolved Oxygen Membrane:

<i>Membrane Type</i>	<i>Flow Dependence After 4 Minutes</i>	<i>Required Sample Movement</i>	<i>Typical Response Time (T-95)</i>
5913, 5908 Yellow	25%	6 inches/second	8 seconds
5914, 5909 Blue	18%	3 inches/second	17 seconds

## AUTO STABLE

Auto Stable utilizes preset values to indicate when a reading is stable. The preset values are adjustable in the System Setup menu. The user can input a % change in readings (0.0 to 1.9) over 'x' amount of time in seconds (3-19). There are two separate Auto Stable controls, one for dissolved oxygen readings (DO Auto Stable) and one for conductivity readings (Cond. Auto Stable).

Highlight either DO Auto Stable or Cond. Auto Stable, then press enter to open the submenu.

Use the up or down arrow keys to highlight the % change or seconds (secs) input field, then press enter to make the highlighted field adjustable. Use the up or down arrow keys to adjust the selected value, then press enter to confirm changes. Once you have confirmed any changes, highlight the ESC-Exit box along the bottom of the display and press enter to close the Auto Stable submenu.

To disable Auto Stable, set the % Change input to 0.0.

When Auto Stable is enabled, an **AS** symbol will display next to the reading on the Run screen and blink during stabilization. When the dissolved oxygen and/or conductivity reading stabilizes based on the Auto Stable settings, the **AS** symbol will display steadily and the instrument will beep twice if Audio is turned on.

## DO UNITS

---

Highlight DO Units and press enter to open a submenu that allows you to select the dissolved oxygen units to be displayed on the Run screen. Highlight a unit and press enter to enable or disable it. An enabled dissolved oxygen unit will have an 'X' in the box next to it. Highlight the ESC-Exit box along the bottom of the display and press enter to save any changes and to close the DO units submenu.

There are three options for displaying dissolved oxygen:

- mg/L will show DO readings in milligrams per liter on a scale from 0 to 50 mg/L.
- ppm (parts per million) is equivalent to mg/L and will show the DO reading on a scale from 0 to 50 ppm.
- % will show DO readings in a % saturation from 0 to 500%. This value will be expressed as %L when DO Local% is enabled.

mg/L and ppm cannot be enabled and therefore displayed at the same time. DO% and mg/L or ppm can be enabled and displayed simultaneously.

## CONDUCTIVITY UNITS (COND. UNITS)

---

Highlight Cond. Units (Conductivity Units) and press enter to open a submenu that allows you to select the conductivity units to be displayed on the Run screen. Highlight a unit and press enter to enable or disable it. An enabled conductivity unit will have an 'X' in the box next to it. Highlight the ESC-Exit box along the bottom of the display and press enter to save any changes and to close the conductivity units submenu.

There are seven options for displaying conductivity. Only two units can be enabled at the same time:

- COND-mS/cm displays conductivity in milliSiemens per centimeter.
- COND-uS/cm displays conductivity in microSiemens per centimeter.
- SPC-mS/cm displays Specific Conductance in milliSiemens per centimeter. Specific Conductance is temperature compensated conductivity.
- SPC-uS/cm displays Specific Conductance in microSiemens per centimeter. Specific Conductance is temperature compensated conductivity.
- Sal ppt displays salinity in parts per thousand. The salinity reading is calculated from the instrument's conductivity and temperature values using algorithms found in *Standard Methods for the Examination of Water and Wastewater*.

- TDS g/L displays Total Dissolved Solids in grams per liter. TDS is calculated from conductivity and temperature using a user-selectable TDS constant.
- TDS mg/L displays Total Dissolved Solids in milligrams per liter. TDS is calculated from conductivity and temperature using a user-selectable TDS constant.

Note: 1 milliSiemen = 1,000 microSiemens.

## SPECIFIC CONDUCTANCE

---

The conductivity of a sample is highly dependent on temperature, varying as much as 3% for each change of one degree Celsius (temperature coefficient = 3%/°C). In addition, the temperature coefficient itself varies with the nature of the ionic species present in the sample. Therefore, it is useful to compensate for this temperature dependence in order to quickly compare conductivity readings taken at different temperatures.

The Pro2030 can display non-temperature compensated conductivity as well as temperature compensated Specific Conductance. If Specific Conductance is selected, the Pro2030 uses the temperature and conductivity values associated with each measurement to calculate a specific conductance value compensated to a user selected reference temperature, see below. Additionally, the user can select the temperature coefficient from 0% to 4%.

Using the Pro2030's default reference temperature and temperature coefficient (25 °C and 1.91%), the calculation is carried out as follows:

$$\text{Specific Conductance (25°C)} = \frac{\text{Conductivity of sample}}{1 + 0.0191 * (T - 25)}$$

T = Temperature of the sample in °C

## SPECIFIC CONDUCTANCE REFERENCE TEMPERATURE (SPC REF. TEMP.)

---

SPC Ref. Temp. (Specific Conductance Reference Temperature) is the reference temperature used to calculate Specific Conductance. The reference temperature range is 15 and 25 °C. The default value is 25 °C.

To change the reference temperature, highlight SPC Ref. Temp. and press enter to open the submenu. With the reference temperature highlighted, press enter to make the field adjustable. Next, use the up or down arrow key to increase or decrease the value. Press enter to save the new reference temperature. Next, highlight the ESC-Exit box and press enter to close the submenu.



## **SPECIFIC CONDUCTANCE TEMPERATURE COEFFICIENT (SPC %/°C)**

---

SPC %/°C (Specific Conductance Temperature Coefficient) is the temperature coefficient used to calculate Specific Conductance. The coefficient range is 0.00 to 4.00. The default value is 1.91% which is based on KCl standards.

To change the temperature coefficient, highlight SPC %/°C and press enter to open the submenu. With the temperature coefficient highlighted, press enter to make the field adjustable. Next, use the up or down arrow key to increase or decrease the value. Press enter to save the new coefficient. Next, highlight the ESC-Exit box and press enter to close the submenu.

## **TDS CONSTANT**

---

TDS Constant is a multiplier used to calculate an estimated TDS (Total Dissolved Solids) value from conductivity. The multiplier is used to convert Specific Conductance in mS/cm to TDS in g/L. The Pro2030's default value is 0.65. This multiplier is highly dependent on the nature of the ionic species present in the water sample. To be assured of moderate accuracy for the conversion, you must determine a multiplier for the water at your sampling site. Use the following procedure to determine the multiplier for a specific sample:

1. Determine the specific conductance of a water sample from the site;
2. Filter a sample of water from the site;
3. Completely evaporate the water from a carefully measured volume of the filtered sample to yield a dry solid;
4. Accurately weigh the remaining solid;
5. Divide the weight of the solid (in grams) by the volume of water used (in liters) to yield the TDS value in g/L for this site;
6. Divide the TDS value in g/L by the specific conductance of the water in mS/cm to yield the conversion multiplier. Be certain to use the correct units.

If the nature of the ionic species at the site changes between sampling studies, the TDS values will be in error. TDS cannot be calculated accurately from specific conductance unless the make-up of the chemical species in the water remains constant.

To change the TDS Constant in the Pro2030, highlight TDS Constant and press enter to open the submenu. With the TDS Constant highlighted, press enter to make the field adjustable. Next, use the up or down arrow key to increase or decrease the value. The input range is 0.30 to 1.00. Press enter to save the new TDS Constant. Next, highlight the ESC-Exit box and press enter to close the submenu.

## **TEMPERATURE UNITS**

---

Highlight Temperature Units and press enter to open a submenu that allows you to change the temperature units displayed on the Run screen. Highlight the desired unit (Celsius or Fahrenheit) and press enter to enable. The enabled temperature unit will have an 'X' in the box next to it. Only one unit may be enabled at a time. Highlight the ESC-Exit box and press enter to save any changes and to close the Temperature Units submenu.

## **PRESSURE UNITS**

---

Highlight Pressure Units and press enter to open a submenu that allows you to change the barometric pressure units displayed on the Run screen. Highlight the desired unit (mmHg, inHg, mbar, psi, or kPa) and press enter to enable. The enabled pressure unit will have an 'X' in the box next to it. Only one unit may be enabled at a time. Highlight the ESC-Exit box and press enter to save any changes and to close the Pressure Units submenu.

## **LANGUAGE**

---

Highlight Language and press enter to open a submenu that allows you to change the language. Highlight the desired language (English, Spanish, German, or French) and press enter to enable. The enabled language will have an 'X' in the box next to it. Highlight ESC-Exit box and press enter to save any changes and to close the Language submenu.

The text in the boxes along the bottom of the Run screen will always be displayed in English regardless of the language enabled in the System Setup menu.


## **AUTO SHUTOFF**

---

Auto Shutoff allows you to set the instrument to turn off automatically after a period of time. Use the up or down arrow keys to highlight Auto Shutoff, then press enter to open the submenu. Press enter while the minute field is highlighted to make it adjustable. Next, use the up or down arrow keys to adjust the shut off time from 0 to 60 minutes. Press enter to save the new shutoff time. Next, highlight the ESC-Exit box and press enter to close the submenu.

To disable Auto Shutoff, set the Time in Minutes to 0 (zero).

## RESETTING THE SYSTEM SETUP MENU TO FACTORY DEFAULT

To reset the Pro2030 settings to factory default, press the down arrow key while in the System Setup menu until the Reset -  box is highlighted, then press enter. The instrument will ask you to confirm the reset. Highlight Yes and press enter to continue with the reset or highlight No and press enter to cancel the reset. A Factory Reset will not affect data saved in the instrument's memory.

The following will be set in the Pro2030 after performing a reset:

<i>Parameter</i>	<i>Reset Defaults</i>
DO Local%	Off
LDS (Last Digit Suppression)	Off
Quick DO Cal	Off
Audio	On
Contrast	Set to mid range
Dissolved Oxygen Sensor Type	Last Setting Confirmed
Dissolved Oxygen Membrane Type	Last Setting Confirmed
Dissolved Oxygen Auto Stable	Off (0.0 % Change and 10 seconds)
Dissolved Oxygen Units	mg/L and %
Conductivity Units	cond mS/cm and spc mS/cm
Conductivity Auto Stable	Off (0.0 % Change and 10 seconds)
SPC Reference Temperature	25°C
SPC Temperature Coefficient	1.91%/°C
TDS Constant	0.65
Temperature Units	°C
Pressure Units	mmHg
Language	English
Auto Shutoff	30 minutes
Dissolved Oxygen Calibration	Reset to 100% for enabled membrane and sensor.
Conductivity Calibration	Cell constant reset to 5.0
Barometer Calibration	Reset to factory default*

\*It is recommended to perform a barometer and dissolved oxygen calibration after performing a reset.

## CALIBRATION

### TEMPERATURE

All Pro2030 cables have built-in temperature sensors. Temperature calibration is not required nor is it available.

### BAROMETER

The barometer in the Pro2030 is calibrated at the factory. The barometer reading must be accurate to ensure accurate DO% calibrations and readings. If the barometer requires an adjustment, use the up or down arrow keys to highlight the barometer box along the bottom of the Run screen, then press enter. Next, use the up or down arrow keys to adjust the barometer reading to the local, true barometric pressure. Continually depress the up or down arrow key to change the barometer value more rapidly. Press enter to confirm and save the barometer adjustment.



*Do not use a barometer value that is corrected to sea level. Laboratory barometer readings are usually “true” (uncorrected) values of air pressure and can be used “as is” for barometer calibration. Weather service readings are usually not “true”, i.e., they are corrected to sea level, and therefore cannot be used until they are “uncorrected”. An approximate formula for this “uncorrection” is:*

$$\text{True BP} = [\text{Corrected BP}] - [2.5 * (\text{Local Altitude in ft above sea level}/100)]$$

Although the Pro2030 barometer range is 400.0 to 999.9 mmHg, you will be unable to adjust the value across the entire range. The barometer is very accurate and the instrument will not allow you to adjust the value drastically beyond what it is measuring.

### DISSOLVED OXYGEN

The dissolved oxygen sensor can be easily calibrated with the press of two or three keys by enabling Quick DO Cal in the System Setup menu and following the Quick DO Calibration procedure.

Ensure the barometer is reading accurately before performing a Quick DO Cal, DO% or DO Local% calibration because these calibration procedures use the barometer reading during calibration. If the barometer reading is erroneous during a calibration, the dissolved oxygen measurements will be inaccurate.



*It is not necessary to calibrate in both % and mg/L or ppm. Calibrating in % will simultaneously calibrate mg/L and ppm and vice versa. YSI recommends calibrating the dissolved oxygen sensor in % for both ease and accuracy.*

---

## QUICK DO CALIBRATION

---

Perform this calibration procedure when Quick DO Calibration is enabled in the System Setup menu.

1. Ensure the DO sensor has a good membrane with electrolyte installed. A good membrane is free of wrinkles, tears, fouling and air bubbles. Install the sensor guard onto the probe.
2. Moisten the sponge in the grey calibration/storage sleeve with a small amount of clean water and install it over the sensor guard. The sponge should only be moistened and the calibration/storage sleeve should not have excess water in it that could cause water droplets to get on the membrane. The storage sleeve ensures venting to the atmosphere.
3. Power the instrument on and, if using a Polarographic sensor, wait approximately 5 to 15 minutes for the storage chamber to become completely saturated and for the sensor to stabilize. If using a Galvanic sensor, wait approximately 5 to 10 minutes for the chamber to become completely saturated. Auto Shutoff should be disabled or set to at least 20 minutes. See System Setup menu for more information on adjusting the Auto Shutoff.
4. Ensure the barometer is reading accurately. If necessary, perform a barometer calibration.
5. Press and hold the Calibrate key for 3 seconds. Using the up or down arrow key, highlight Dissolved Oxygen and press enter. The Pro2030 will indicate 'Calibrating %DO' on the display. The instrument will automatically calibrate the sensor to the current barometric pressure. If DO Local% is enabled, the sensor will calibrate to 100%. This may take up to 2 minutes depending on the age of the sensor and membrane. You can press the Cal key at this time to cancel the calibration.
6. 'Calibration Successful' will display for a few seconds to indicate a successful calibration and then the instrument will return to the Run screen.
7. If the calibration is unsuccessful, an error message will display on the screen. Press the Cal key to exit the error message and return to the Run screen. See the Troubleshooting guide for possible solutions.

---

## CALIBRATING IN PERCENT (DO%)

---

Perform this calibration procedure when Quick DO Cal is disabled in the System Setup menu.

1. Perform steps 1-4 of the Quick DO Calibration procedure.
2. Press and hold the Calibrate key for 3 seconds. Highlight Dissolved Oxygen and press enter. Next, highlight % and press enter.
3. The Pro2030 will display the current DO% and temperature readings along with the % calibration value. The % calibration value is based on the barometer reading.
4. Wait at least 3 seconds, then, once the DO% and temperature readings are stable, press enter to complete the calibration. Or, press the Cal key to cancel the calibration.
5. 'Calibration Successful' will display for a few seconds to indicate a successful calibration and then the instrument will return to the Run screen.
6. If the calibration is unsuccessful, an error message will display on the screen. Press the Cal key to exit the calibration error message and return to the Run screen. See the Troubleshooting guide for possible solutions.

---

## CALIBRATING IN PERCENT (DO LOCAL% ENABLED)

---

Perform this calibration procedure when DO Local% is enabled in the System Setup menu.

1. Perform steps 1-4 of the Quick DO Calibration procedure.
2. Press and hold the Cal key for 3 seconds. Highlight Dissolved Oxygen and press enter.
3. %Local will automatically be highlighted, press enter. The Pro2030 will display the current DO% and temperature readings along with the % calibration value. The % calibration value will always be 100% for DO Local%.
4. Wait at least 3 seconds, then, once the DO% and temperature readings stabilize, press enter to complete the calibration. Or, press the Cal key to cancel the calibration.
5. 'Calibration Successful' will display for a few seconds to indicate a successful calibration and then the instrument will return to the Run screen.
6. If the calibration is unsuccessful, an error message will display on the screen. Press the Cal key to exit the calibration error message and return to the Run screen. See the Troubleshooting guide for possible solutions.

---

## CALIBRATING IN MG/L OR PPM

---

1. Power the instrument on and place the sensor into a sample that has been titrated to determine the dissolved oxygen concentration. The sample should cover the two holes of the conductivity sensor that are located near the cable, see figure 8. During the calibration, continuously stir or move the probe through the sample at a rate of at least 6 inches (15.5 cm) per second if using a yellow membrane or at least 3 inches (7.7 cm) per second if using a blue membrane. A stir plate may be helpful for this calibration procedure.
2. Allow the dissolved oxygen and temperature readings to stabilize. This may take 5 to 15 minutes, depending on the type and condition of the sensor.
3. Press the Cal key. Highlight Dissolved Oxygen and press enter.
4. Highlight mg/L or ppm depending on what is enabled in the System Setup menu and press enter.
5. Use the up and down arrow keys to adjust the mg/L (ppm) reading to the value of the titrated sample. Press enter to confirm the value and complete the calibration or press the Cal key to cancel the calibration.
6. 'Calibration Successful' will display for a few seconds to indicate a successful calibration and then the instrument will return to the Run screen.
7. If the calibration is unsuccessful, an error message will display on the screen. Press the Cal key to exit the calibration error message and return to the Run screen. See the Troubleshooting guide for possible solutions.

---

## CONDUCTIVITY CALIBRATION

---

Ensure the conductivity sensor is clean and dry before performing a conductivity, specific conductance or salinity calibration.



*It is not necessary to calibrate conductivity, specific conductance and salinity. Calibrating one of these parameters will simultaneously calibrate the others. YSI recommends calibrating specific conductance for greatest ease.*

---

## CALIBRATING SPECIFIC (SP.) CONDUCTANCE OR CONDUCTIVITY

---

Note: When calibrating Specific Conductance, the Pro2030 uses the factory default values for the Specific Conductance Reference Temperature and the Specific Conductance Temperature Coefficient regardless of what is configured in the System Setup Menu. The default value for the Reference Temperature is 25°C

and the default value for the Temperature Coefficient is 1.91%/°C. It is important to note that the Temperature Coefficient of a calibration solution is dependent on the contents of the solution. Therefore, YSI recommends using a traceable calibration solution made of KCl (potassium chloride) when calibrating Specific Conductance since these solutions typically have a Temperature Coefficient of 1.91%/°C. Additionally, be sure to enter the value of the solution as it is listed for 25°C when calibrating Specific Conductance.

1. Fill a clean container (i.e. plastic cup or glass beaker) with fresh, traceable conductivity calibration solution and place the sensor into the solution. The solution must cover the holes of the conductivity sensor that are closest to the cable (figure 8). Ensure the entire conductivity sensor is submerged in the solution or the instrument will read approximately half the expected value. Gently move the probe up and down to remove any air bubbles from the conductivity sensor.

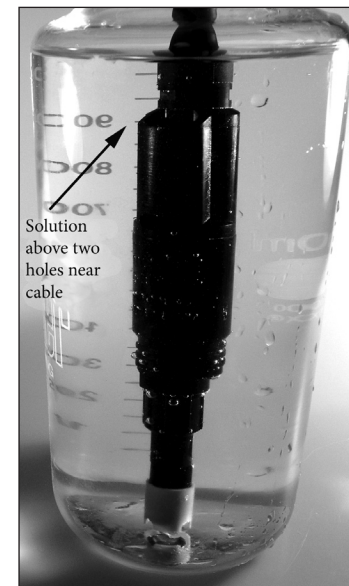


Figure 8, solution above two holes near cable.

2. Turn the instrument on and allow the conductivity and temperature readings to stabilize. Press the Cal key. Highlight Conductivity and press enter. Next, highlight the desired calibration method, Sp. Conductance or Conductivity, and press enter.
3. Highlight the units you wish to calibrate, either uS/cm or mS/cm, and press enter. 1 mS = 1,000 uS. Next, use the up or down arrow key to adjust the value on the display to match the value of the conductivity calibration solution. If calibrating conductivity, it is necessary to look

up the value of the solution at the current temperature and enter that value into the Pro2030. Most conductivity solutions are labeled with a value at 25°C. If calibrating specific conductance, enter the value listed for 25°C. Depressing either the up or down arrow key for 5 seconds will move the changing digit one place to the left. The Pro2030 will remember the entered calibration value and display it the next time a conductivity calibration is performed.

4. Press enter to complete the calibration. Or, press Cal to cancel the calibration and return to the Run screen.
5. 'Calibration Successful' will display for a few seconds to indicate a successful calibration and then the instrument will return to the Run screen.
6. If the calibration is unsuccessful, an error message will display on the screen. Press the Cal key to exit the calibration error message and return to the Run screen. See the Troubleshooting guide for possible solutions.

---

## CALIBRATING IN SALINITY

---

1. Fill a clean container (i.e. plastic cup or glass beaker) with fresh, traceable salinity calibration solution and place the sensor into the solution. The solution must cover the holes of the conductivity sensor that are closest to the cable (figure 8). Ensure the entire conductivity sensor is submerged in the solution or the instrument will read approximately half the expected value. Gently move the probe up and down to remove any air bubbles from the conductivity sensor.
2. Turn the instrument on and allow the conductivity and temperature readings to stabilize. Press the Cal key. Highlight Conductivity and press enter. Next, highlight Salinity and press enter.
3. Use the up or down arrow key to adjust the value on the display to match the value of the salinity solution. Depressing either the up or down arrow key for 5 seconds will move the changing digit one place to the left. The Pro2030 will remember the entered calibration value and display it the next time a salinity calibration is performed.
4. Press enter to complete the calibration. Or, press Cal to cancel the calibration and return to the Run screen.
5. 'Calibration Successful' will display for a few seconds to indicate a successful calibration and then the instrument will return to the Run screen.
6. If the calibration is unsuccessful, an error message will display on the screen. Press the Cal key to exit the calibration error message and return to the Run screen. See the Troubleshooting guide for possible solutions.

---

## TAKING MEASUREMENTS

---

Before taking measurements, be sure the instrument has been calibrated to ensure the most accurate readings. Turn the instrument on and wait 5-15 minutes if using a polarographic sensor. Install the sensor guard to protect the sensor and membrane. Place the probe in the sample to be measured and give the probe a quick shake to release any air bubbles. Be sure the conductivity sensor is completely submerged in the sample. The two holes near the cable should be covered by the sample for accurate conductivity readings (figure 8).

Allow the temperature readings to stabilize. Next, stir the probe in the sample to overcome the stirring dependence of the dissolved oxygen sensor. The dissolved oxygen sensor requires at least 6 inches (16 cm) per second of water movement if using the yellow membrane and 3 inches (7.62 cm) per second of water movement if using the blue membrane. The required sample movement can be achieved by the natural flow of the stream, physically stirring the probe in the sample or a combination of the two. Once the values plateau and stabilize you may record the measurement and/or store the data set. The dissolved oxygen reading will drop over time if stirring or movement is ceased. If placing the DO sensor into a stream or fast flowing waters it is best to place it perpendicular to the flow and not facing into the flow.

If using the DO sensor near an aeration device, it is helpful to make sure air bubbles do not burst on the membrane since that may cause unstable DO readings. You should be able to prevent this by pointing the sensor upwards so it's facing the sky and twist tying, zip tying or rubber banding the bulkhead to the cable. Essentially, making a simple curve to the cable without bending or breaking the cable will allow you to lower the sensor into the aerated sample while the sensor points skyward and air bubbles are no longer bursting on the membrane surface.

---

## SAVING AND VIEWING DATA

---

The Pro2030 can store 50 data sets in non-volatile memory for later viewing. A data set includes the values currently on the display, i.e. temperature, dissolved oxygen and two conductivity parameters. Each data point is referenced with a data set number, 01 through 50.

---

### SAVING DATA

---



*The Pro2030 can not communicate to a PC via a Pro Series communications saddle. Connecting the Pro2030 to a communication saddle may cause erratic instrument behavior.*

From the Run screen, use the up or down arrow keys to highlight the Save box and press enter to save the current readings. The instrument will indicate the data set is saved and display the saved data set's number (figure 9).

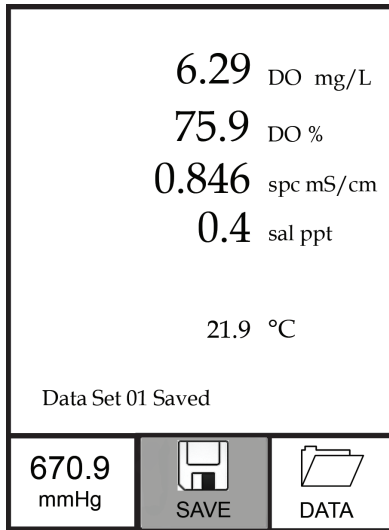


Figure 9, data set saved.

The instrument will display 'Memory Full' if all 50 data sets have been saved and you attempt to save another data set.

### VIEWING AND ERASING SAVED DATA - DATA MODE

Data mode allows you to view and erase saved data. From the Run screen, use the up or down arrow keys to highlight Data and press enter to access Data mode. Note that the function boxes at the bottom of the display are different in Data mode (figure 10).

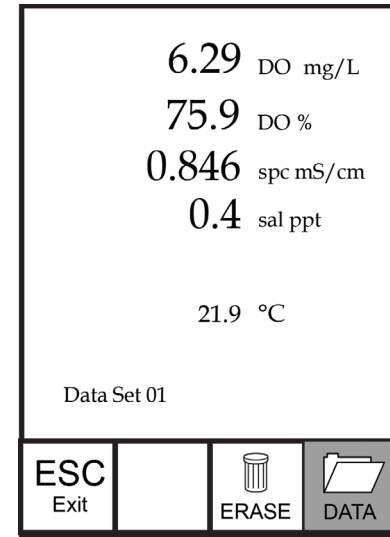


Figure 10, Data mode.

---

### VIEWING DATA

Once in Data mode, use the up and down arrow keys to view saved data sets in sequential order or press enter to access the bottom functions. After accessing the bottom functions, highlight the Data box and press enter to regain access to viewing data. The data set displayed is indicated by the data set number, 01 through 50.

---

### ERASING DATA

While viewing saved data, press the enter key to access the function boxes at the bottom of the display. Next, use the up or down arrow keys to highlight Erase, then press enter. The instrument will give you the option to erase one data set or all data sets (figure 11).

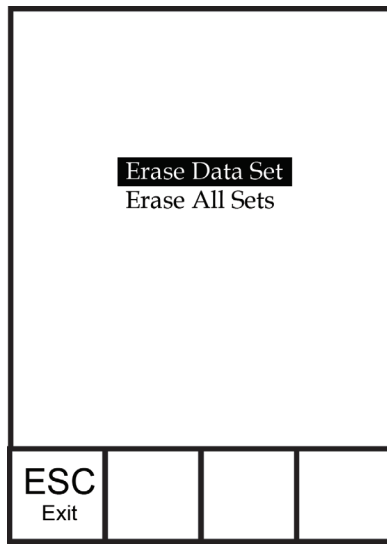


Figure 11, Erase data mode.

Use the up or down arrow key to select Erase Data Set, Erase All Sets or the ESC-Exit function box, then press enter to confirm.

Select ESC-Exit and press enter to exit Erase mode without erasing any data.

Select Erase Data Set and press enter to erase the data set that was displayed before entering Erase mode. For example, if data set 12 was displayed before entering erase mode, and Erase Data Set is selected, Data Set 12 will be erased from memory and the data sets AFTER that number will move up to keep them sequential. For example, if there are 15 records and number 12 is erased then 13 becomes 12, 14 becomes 13, and 15 becomes 14. The instrument will return to Data mode after erasing one data set.

Select Erase All Data Sets and press enter to clear the Pro2030 memory and return to Data mode.

---

## EXITING DATA MODE

---

While in Data mode, press enter to access the bottom functions. Next, highlight the ESC-Exit box and press enter to return to the Run screen.

## CARE, MAINTENANCE AND STORAGE

---

This section describes the proper procedures for care, maintenance and storage of the sensors. The goal is to maximize their lifetime and minimize down-time associated with improper sensor usage.

### GENERAL MAINTENANCE

---

#### GENERAL MAINTENANCE - GASKET AND O-RINGS

---

The instrument utilizes a gasket and o-rings as seals to prevent water from entering the battery compartment and the sensor port. Following the recommended procedures will help keep the instrument functioning properly.

If the gasket, o-rings and sealing surfaces are not maintained properly, it is possible that water can enter the battery compartment and/or sensor port of the instrument. If water enters these areas, it can severely damage the battery terminals or sensor port causing loss of battery power, false readings and corrosion to the sensors or battery terminals. Therefore, when the battery compartment lid is removed, the gasket that provides the seal should be carefully inspected for contamination (i.e. debris, grit, etc.) and cleaned with water and mild detergent if necessary.

The same inspection should be made of the o-rings associated with the dissolved oxygen sensor connector if and when the DO sensor is removed. If no dirt or damage to the o-rings is evident, then they should be lightly greased with the o-ring grease provided without removing them from their groove. However, if there is any indication of damage, the sensor o-ring should be replaced with an identical o-ring.

#### To remove the DO sensor o-rings:

Use a small, flat-bladed screwdriver or similar blunt-tipped tool to remove the o-ring from its groove near the sensor connector. Check the o-ring and the groove for any excess grease or contamination. If contamination is evident, clean the o-ring and nearby plastic parts with lens cleaning tissue or equivalent lint-free cloth. Alcohol can be used to clean the plastic parts, but use only water and mild detergent on the o-ring itself. Also, inspect the o-rings for nicks and imperfections.



*Using alcohol on o-rings may cause a loss of elasticity and may promote cracking. Do not use a sharp object to remove the o-rings. Damage to the o-ring or the groove may result.*

Before re-installing the DO sensor o-rings, make sure to use a clean workspace, clean hands and avoid contact with anything that may leave fibers on the o-ring or grooves. Even a very small amount of contamination (hair, grit, etc.) may create a path for water intrusion or contamination.

To re-install the DO sensor o-rings:

Place a small amount of o-ring grease between your thumb and index finger. (More grease is not better!)

Draw the o-ring through the grease while pressing the fingers together to place a very light covering of grease on the o-ring. Place the o-ring into its groove ensuring that it does not twist or roll.

Use the previously grease-coated finger to once again lightly go over the surface of the o-ring.

**i** Do not over-grease the o-rings. The excess grease may collect grit particles that can compromise the seal. Excess grease can also cause the waterproofing capabilities of the o-ring to diminish, potentially causing leaks. If excess grease is present, remove it using a lens cloth or lint-free cloth.

---

## GENERAL MAINTENANCE - DO SENSOR PORT

---

It is important that the entire sensor connector end be dry when installing, removing or replacing the sensor. This will prevent water from entering the port. Once the DO sensor is removed, examine the connector inside the port. If any moisture is present, use compressed air to completely dry the connector or let it air dry. If the connector is corroded, contact YSI Technical Support or the YSI authorized dealer where you purchased the instrument.

**i** Remove sensors upside down (facing the ground) to help prevent water from entering the port upon removal.

---

## SENSOR MAINTENANCE

---

---

### SENSOR MAINTENANCE - TEMPERATURE

---

You must keep the temperature sensor free of build up. Other than that, no additional maintenance is required. A toothbrush can be used to scrub the temperature sensor if needed.

---

## SENSOR MAINTENANCE - CONDUCTIVITY

---

The openings that allow sample access to the conductivity electrodes should be cleaned regularly. The small cleaning brush included in the Maintenance Kit is intended for this purpose. Dip the brush in clean water and insert it into each hole 10 to 12 times. In the event that deposits have formed on the electrodes, it may be necessary to use a mild detergent (laboratory grade soap or bathroom foaming tile cleaner) with the brush. Rinse thoroughly with clean water, then check the response and accuracy of the conductivity cell with a calibration solution.

---

## SENSOR MAINTENANCE - DISSOLVED OXYGEN

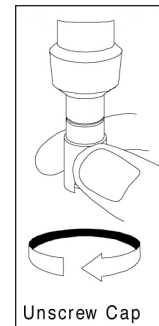
---

### Membrane Cap Installation

---

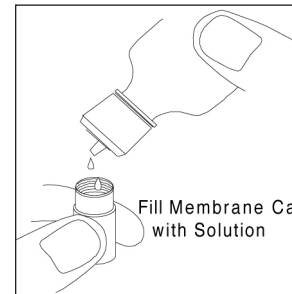
The DO sensor (Polarographic or Galvanic) is shipped with a protective red cap that needs to be removed before using. Remove the red protective cap or used cap membrane and replace it with a new cap membrane following these instructions:

Remove the sensor guard to access the sensor.



Remove the protective red cap by pulling it straight off the sensor. Or, unscrew and remove the used cap membrane by holding the sensor while unscrewing the cap membrane. Discard the used cap membrane.

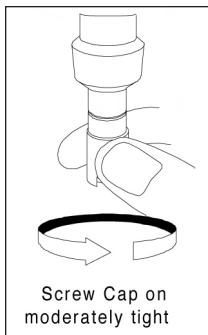
Thoroughly rinse the sensor tip with distilled or deionized water.



Fill a new cap membrane 3/4 full with electrolyte solution that has been prepared according to the directions on the bottle. Be very careful not to touch the membrane surface.

Lightly tap the side of the cap membrane to release bubbles that may be trapped.





Thread the cap membrane onto the sensor. It is normal for a small amount of electrolyte to overflow.

Replace the sensor guard.

### Polarographic Sensors – Model # 605203

The cap membrane and KCl (potassium chloride) electrolyte solution should be changed every 2-4 weeks during regular use. In addition, the electrolyte solution and membrane should be changed if (a) bubbles are visible under the membrane; (b) significant deposits of dried electrolyte are visible on the membrane; and (c) if the sensor shows unstable readings or other sensor-related symptoms.

During membrane changes, examine the gold cathode at the tip of the sensor and the silver anode along the shaft of the sensor (figure 12). If either the silver anode is black in color or the gold cathode is dull, the sensor may need resurfaced using the 400 grit wet/dry sanding discs included in the membrane kit. Do not sand the electrode every membrane change as this is not routine maintenance. In fact, visually, the anode may appear tarnished and operate properly. YSI recommends using the sanding disc if the sensor has difficulty stabilizing or calibrating after a regular membrane change.

To clean and resurface the sensor, follow the instructions on the next page.

#### Gold Cathode

For correct sensor operation, the gold cathode (figure 12) must be textured properly. It can become tarnished or plated with silver after extended use. Never use chemicals or abrasives that have not been recommended or supplied by YSI.

First dry the sensor tip completely with lens cleaning tissue. Wet a sanding disc and place it face up in the palm of your hand. Next, with your free hand, hold the sensor in a vertical position, tip down. Place the sensor tip directly down on the sanding disc and twist it in a circular motion to sand the gold cathode. The goal is to sand off any build-up and to lightly scratch the cathode to provide a larger surface area for the electrolyte solution under the membrane. Usually, 3 to 4 twists of the sensor are sufficient to remove deposits and for the gold to appear to have a matte finish. Rinse the sensor thoroughly with distilled or deionized

water and wipe the gold cathode with a wet paper towel before putting on a new cap membrane. If the cathode remains tarnished, contact YSI Technical Support or the YSI authorized dealer where you purchased the instrument.

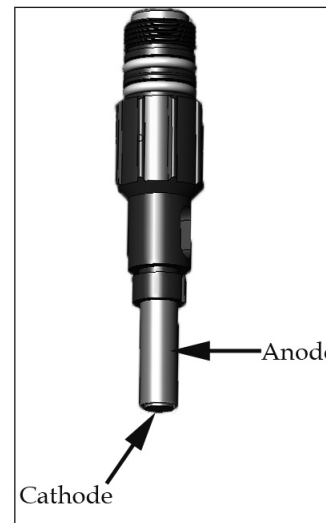


Figure 12, DO sensor with membrane removed.

#### Silver Anode

After extended use, a thick layer of Silver Chloride (AgCl) builds up on the silver anode (figure 12) reducing the sensitivity of the sensor. The anode must be cleaned to remove this layer and restore proper performance. The cleaning can be chemical and/or mechanical:

**Mechanical cleaning:** In order to sand the silver anode along the shaft of the sensor, simply hold the sensor in a vertical position. Wet the sanding disc and gently wrap it around the sensor and twist it a few times to lightly sand the anode (the goal is to simply sand off any build-up without scratching or removing layers of the anode itself). Usually, 3 to 4 twists of the sanding disc are sufficient to remove deposits.

After completing the sanding procedure, repeatedly rinse the electrode with distilled or deionized water and wipe with lens cleaning tissue to remove any grit left by the sanding disc. Thoroughly rinse the entire tip of the sensor with distilled or deionized water and install a new membrane.



**IMPORTANT:** Be sure to: (1) Use only the fine sanding discs provided and (2) Sand as mentioned in the above procedures. Not adhering to either of these instructions can damage the electrodes.

Chemical cleaning: Remove the cap membrane and rinse the sensor with deionized or distilled water. Soak the sensing section of the sensor in a 14% ammonium hydroxide solution for 2 to 3 minutes or in a 3% ammonia solution overnight for 8-12 hours (most household ammonia cleaners are typically around 3%). Rinse heavily in cool tap water followed by a thorough rinsing with distilled or deionized water. The anode should then be thoroughly wiped with a wet paper towel to remove the residual layer from the anode. Trapping residual ammonia under the new membrane cap can quickly tarnish the electrode and/or give false readings and should therefore be avoided.

After performing a chemical cleaning on the polarographic sensor, lightly sand the cathode and anode following the mechanical cleaning procedures described previously.

**i** *Chemical cleaning should be performed as infrequently as possible. First attempt a membrane change and recalibrate. If a new membrane does not resolve the problem, then proceed with cleaning.*

If this procedure is unsuccessful, as indicated by improper sensor performance, contact YSI Technical Support or the YSI authorized dealer where you purchased the instrument.

#### Galvanic Sensors – Model # 605202

YSI recommends that the Sodium Chloride (NaCl) electrolyte solution and cap membrane be changed every 2-4 weeks during regular use. In addition, the electrolyte solution and membrane should be changed if (a) bubbles are visible under the membrane; (b) significant deposits of dried electrolyte are visible around the membrane; and (c) if the sensor shows unstable readings or other sensor-related symptoms.

The Galvanic dissolved oxygen sensor is continuously reducing oxygen even when the instrument is turned off. This factor allows the sensor to be used with no warm-up period as soon as the instrument is powered on. However, because the sensor is “on” all the time, some solid from the oxidation of the zinc anode will form in the electrolyte within 1-2 weeks of activation. Small amounts of the solid will generally cause no performance problems, but excessive amounts may result in jumpy dissolved oxygen readings. The rate of solid formation is dependent on the type of membrane installed. The formation of solids typically form more rapidly with 5913 (1.25 mil PE) membrane, and less rapid with 5914 (2 mil PE) membranes.

**i** *The Galvanic electrolyte solution will appear milky white after use but this will not affect the accuracy of the sensor unless there is excessive build up. The color change is acceptable and normal as long as DO readings remain stable.*

At the time the cap membrane is changed, YSI recommends that you rinse the anode and cathode (figure 12) with distilled or deionized water and wipe with a clean paper towel. If white deposits are evident on the anode after cleaning, YSI recommends that you remove this material by sanding the anode with the 400 grit wet/dry sanding disc included in the membrane kit following the “Mechanical Cleaning” instructions under the Polarographic Silver Anode maintenance section of this manual. If there are deposits on the cathode, sand the cathode with the 400 grit wet/dry sanding disc following the maintenance instructions listed in this manual for the Polarographic Gold Cathode.

**i** *IMPORTANT: Be sure to: (1) Use only the fine sanding discs provided and (2) Sand as mentioned in the above procedures. Not adhering to either of these instructions can damage the electrodes.*

**WARNING: Do not perform the Polarographic chemical cleaning on a Galvanic sensor.**

If this procedure is unsuccessful, as indicated by improper sensor performance, contact YSI Technical Support or the YSI authorized dealer where you purchased the instrument.

## SENSOR STORAGE

### SHORT TERM STORAGE

The instrument is supplied with a grey calibration/storage sleeve that slides over the probe guard. The sleeve is used for short-term storage (less than 30 days). Be sure to keep a small amount of moisture (clean tap water) on the sponge in the sleeve during storage. This is simply done to maintain a 100% water saturated air environment which is ideal for short-term sensor storage. The sensors should not be submerged in water.

### LONG TERM STORAGE

The dissolved oxygen and conductivity sensors should be stored long term in a dry state. When storing for more than 30 days, remove the cap membrane and thoroughly rinse the dissolved oxygen sensor with distilled or deionized water. Once the sensor has been rinsed either blow it dry with compressed air or allow

to air dry completely. Next, use a new clean, dry cap membrane to screw over the sensor. This will keep the sensor dry and protect the anode and cathode during storage. Ensure the conductivity sensor is clean and dry.

After storing for a long period of time, it is necessary to “condition” the dissolved oxygen sensor by installing a new membrane with electrolyte solution.

Long Term Storage Temperature: -5 to 70°C (23 to 158°F)

## TROUBLESHOOTING

<i>Symptom</i>	<i>Possible Solution</i>
Instrument will not turn on, a battery symbol appears, or “Critical Shutdown” displays on the screen.	<ol style="list-style-type: none"> <li>1. Low battery voltage, replace batteries.</li> <li>2. Batteries installed incorrectly, check battery polarity.</li> <li>3. Return system for service.</li> </ol>
Barometer reads over/undr and calibrating Dissolved Oxygen results in a Barometric Pressure Over/Undr error message.	<ol style="list-style-type: none"> <li>1. Barometer failure, return system for service</li> </ol>
Temperature values display Over or Undr on Run screen.	<ol style="list-style-type: none"> <li>1. Sample temperature is less than -5° C or more than +55°C. Increase or decrease the sample temperature to bring within the allowable range.</li> <li>2. Contact YSI Tech Support.</li> </ol>
Instrument will not calibrate dissolved oxygen; instrument displays “Calibration Over”, “Calibration Under”, or “Unstable Reading” during calibration.	<ol style="list-style-type: none"> <li>1. Verify barometer reading.</li> <li>2. Verify correct sensor and membrane type selection in the System Setup menu.</li> <li>3. Calibration sleeve may not be 100% water saturated, ensure sponge is moistened.</li> <li>4. Ensure adequate sample movement if performing mg/L or ppm calibration.</li> <li>5. Allow sufficient stabilization time for dissolved oxygen and temperature AND wait at least 3 seconds before confirming a DO% or DO Local% calibration.</li> <li>6. Replace membrane and electrolyte.</li> <li>7. Clean sensor electrodes.</li> <li>8. Contact YSI Tech Support.</li> </ol>

<i>Symptom</i>	<i>Possible Solution</i>
DO readings are inaccurate.	<ol style="list-style-type: none"> <li>1. Verify correct sensor/membrane type selection in the System Setup menu.</li> <li>2. Verify conductivity readings are accurate. Conductivity is used in the calculation of mg/L.</li> <li>3. Verify temperature readings are accurate.</li> <li>4. Sample temperature should be between 0 and 45 °C, the temperature compensation range for DO mg/L.</li> <li>5. DO sensor not properly calibrated, recalibrate the sensor.</li> <li>6. Replace membrane and electrolyte. Recalibrate.</li> <li>7. Clean sensor electrodes.</li> <li>8. Contact YSI Tech Support.</li> </ol>
Dissolved Oxygen values display Over or Undr on Run screen.	<ol style="list-style-type: none"> <li>1. Verify correct sensor/membrane type selection in the System Setup menu.</li> <li>2. If using a polarographic sensor, allow instrument to warm up for 5 – 15 minutes before use.</li> <li>3. Sample dissolved oxygen concentration is more than 50 mg/L or 500%, or less than -0.02 mg/L or -0.3%.</li> <li>4. Verify conductivity readings are accurate.</li> <li>5. Verify temperature readings are accurate.</li> <li>6. Replace membrane and electrolyte. Recalibrate.</li> <li>7. Clean sensor electrodes.</li> <li>8. Contact YSI Tech Support.</li> </ol>

<i>Symptom</i>	<i>Possible Solution</i>
Instrument will not calibrate the Conductivity sensor; instrument displays “Calibration Over”, “Calibration Under”, or “Unstable Reading” during calibration.	<ol style="list-style-type: none"> <li>1. Ensure the conductivity sensor is clean. Follow the cleaning procedures in the Care, Maintenance and Storage section of this manual.</li> <li>2. Verify the calibration solution is above the two holes near the cable, see figure 8.</li> <li>3. Verify the calibration solution is not expired or contaminated. Try a new bottle of solution.</li> <li>4. Ensure you are entering in the correct value for the solution according to the measurement units. 1 mS = 1,000 uS.</li> <li>5. Allow sufficient stabilization time for conductivity and temperature AND wait at least 3 seconds before confirming a calibration.</li> <li>6. Contact YSI Tech Support.</li> </ol>
Conductivity readings are inaccurate.	<ol style="list-style-type: none"> <li>1. Ensure the conductivity sensor is clean. Follow the cleaning procedures in the Care, Maintenance and Storage section of this manual.</li> <li>2. Verify the sample is above the two holes near the cable, see figure 8.</li> <li>3. Verify calibration.</li> <li>4. Verify temperature readings are accurate.</li> <li>5. Verify the correct units are setup in the System Setup menu, i.e. uS vs mS and Conductivity vs. Specific Conductance.</li> <li>6. Contact YSI Tech Support.</li> </ol>
Conductivity values display Over or Undr on Run screen.	<ol style="list-style-type: none"> <li>1. Ensure the conductivity sensor is clean. Follow the cleaning procedures in the Care, Maintenance and Storage section of this manual.</li> <li>2. Verify the sample is above the two holes near the cable, see figure 8</li> <li>3. Verify calibration.</li> <li>4. Verify temperature readings are accurate.</li> <li>5. Sample conductivity is outside the measurement range of the instrument, i.e. 0-200 mS.</li> <li>6. Contact YSI Tech Support.</li> </ol>

## SPECIFICATIONS

These specifications represent typical performance and are subject to change without notice. For the latest product specification information, please visit YSI’s website at [www.ysi.com](http://www.ysi.com) or contact YSI Tech Support.

<i>Parameter</i>	<i>Range</i>	<i>Resolution</i>	<i>Accuracy</i>
Temperature	-5 to 55°C*	0.1°C	± 0.3°C
Dissolved Oxygen	0 to 200% air saturation	1% or 0.1%, user selectable	± 2% of the reading or ± 2% air saturation, whichever is greater
	200 to 500% air saturation	1% or 0.1%, user selectable	± 6% of the reading
	0 to 20 mg/L	0.1 or 0.01 mg/L, user selectable	±2% of the reading or ± 0.2 mg/L, whichever is greater
	20 to 50 mg/L	0.1 or 0.01 mg/L, user selectable	±6% of the reading
Conductivity	0-500 uS/cm 0-5 mS/cm 0-50 mS/cm 0-200 mS/cm (auto ranging)	0.0001 to 0.1 mS/cm; 0.1 to 0 uS/cm (range dependent)	Instrument only: ± 0.5% of the reading or 1 uS/cm, whichever is greater. Instrument with 1 or 4 meter cables: ± 1.0% of the reading or 1 uS/cm, whichever is greater. Instrument with 10, 20, or 30 meter cables: ± 2.0% of the reading or 1 uS/cm, whichever is greater.
Salinity	0 to 70 ppt	0.1 ppt	± 1.0% of the reading or ± 0.1 ppt, whichever is greater.
Total Dissolved Solids (TDS)	0 to 100 g/L. TDS Constant range: 0.3 to 1.00 (0.65 default)	0.0001 to 0.1 g/L (range dependent)	Dependent on accuracy of temperature, conductivity and TDS Constant.
Barometer	500.0 to 800.0 mmHg**	0.1 mmHg	±5 mmHg within 15°C of calibration temperature

\* Automatic dissolved oxygen temperature compensation range is -0 to 45 °C

\*\* Available barometer units include: mmHg, inHg, mbars, psi, or KPa

## ACCESSORIES / PART NUMBERS

<i>Part Number</i>	<i>Description</i>
6052030	Pro2030 Instrument
6262030-1, -4, -10, -20, or -30	1, 4, 10, 20, 30-meter cable assembly*
605202	Galvanic Dissolved Oxygen Sensor
605203	Polarographic Dissolved Oxygen Sensor
603077	Flow cell
603056	Flow cell mounting spike
603075	Carrying case, soft-sided
603074	Carrying case, hard-sided
603069	Belt clip
063517	Ultra clamp for instrument
063507	Tripod for instrument
603062	Cable management kit, included with all cables longer than 1 meter.
605978	Cable weight, 4.9 oz, stackable
603070	Shoulder strap
605306	5908 membrane kit, yellow 1.25 polyethylene for polarographic sensors
605307	5909 membrane kit, blue 2.0 polyethylene for polarographic sensors
605913	5913 membrane kit, yellow 1.25 polyethylene for galvanic sensors
605914	5914 membrane kit, blue 2.0 polyethylene for galvanic sensors
060907	Conductivity Calibration Solution, 1,000 $\mu$ S/cm. 1 box of 8 pints.
060911	Conductivity Calibration Solution, 10,000 $\mu$ S/cm. 1 box of 8 pints.
060660	Conductivity Calibration Solution, 50,000 $\mu$ S/cm. 1 box of 8 pints.
065274	Conductivity Calibration Solution, 100,000 $\mu$ S/cm. 1 box of 8 pints.

\*All cables include a temperature and conductivity sensor. The dissolved oxygen sensor is sold separately.

## DECLARATION OF CONFORMITY

The undersigned hereby declares on behalf of the named manufacturer under our sole responsibility that the listed product conforms to the requirements for the listed European Council Directive(s) and carries the CE mark accordingly.

<i>Manufacturer:</i>	YSI Incorporated 1725 Brannum Lane Yellow Springs, OH 45387 USA
<i>Product Name:</i>	Pro2030 Water Quality Instrument
<i>Model Numbers</i>	
<i>Instrument/Accessory:</i>	Pro2030 (6052030)
<i>Probe/Cable Assemblies:</i>	6052030-1, -4, -10, -20, and -30
<i>Conforms to the following:</i>	
<i>Directives:</i>	IEC 61326-1:2005 RoHS 2002/95/EC WEEE 2002/96/EC
<i>Harmonized Standards:</i>	<ul style="list-style-type: none"> <li>EN61326-1:2006 (IEC 61326-1:2005) Emission &amp; Immunity</li> </ul>
<i>Supplementary Information:</i>	All performance met the operation criteria as follows: 1. ESD, IEC 61000-4-2:2001, Performance Criterion B 2. Radiated Immunity, IEC 61000-4-3, Performance Criterion A 3. Electrical Fast Transient (EFT), IEC 61000-4-4:2004, +Corr. 1:2006 + Corr. 2:2007, Performance Criterion B 4. Radio Frequency, Continuous Conducted Immunity, IEC61000-4-6, Performance Criterion A 5. RF Emissions, EN 61326-1:2006 (IEC61326-1:2005) Class B
<i>Authorized EU Representative</i>	YSI Hydrodata Ltd Unit 2 Focal Point, Lacerta Court, Works Road Letchworth, Hertfordshire, SG6 1FJ UK



Signed: Lisa M. Abel  
Title: Director of Quality

Date: 07 July 2010

## RECYCLING

---

YSI is committed to reducing the environmental footprint in the course of doing business. Even though materials reduction is the ultimate goal, we know there must be a concerted effort to responsibly deal with materials after they've served a long, productive life-cycle. YSI's recycling program ensures that old equipment is processed in an environmentally friendly way, reducing the amount of materials going to landfills.

- Printed Circuit Boards are sent to facilities that process and reclaim as much material for recycling as possible.
- Plastics enter a material recycling process and are not incinerated or sent to landfills.
- Batteries are removed and sent to battery recyclers for dedicated metals.

When the time comes for you to recycle, follow the easy steps outlined at [www.ysi.com](http://www.ysi.com).

## BATTERY DISPOSAL

---

The Pro2030 is powered by alkaline batteries which the user must remove and dispose of when the batteries no longer power the instrument. Disposal requirements vary by country and region, and users are expected to understand and follow the battery disposal requirements for their specific locale.

## CONTACT INFORMATION

---

### ORDERING AND TECHNICAL SUPPORT

---

Telephone: 800 897 4151 (USA)  
+1 937 767 7241 (Globally)  
Monday through Friday, 8:00 AM to 5:00 ET

Fax: +1 937 767 9353 (orders)  
+1 937 767 1058 (technical support)

Email: [environmental@ysi.com](mailto:environmental@ysi.com)  
Mail: YSI Incorporated  
1725 Brannum Lane  
Yellow Springs, OH 45387 USA

Internet: [www.ysi.com](http://www.ysi.com)

When placing an order please have the following available:

- 1.) YSI account number (if available)
- 2.) Name and phone number
- 3.) Purchase Order or Credit Card number
- 4.) Model Number or brief description
- 5.) Billing and shipping addresses
- 6.) Quantity

### SERVICE INFORMATION

---

YSI has authorized service centers throughout the United States and Internationally. For the nearest service center information, please visit [www.ysi.com](http://www.ysi.com) and click 'Support' or contact YSI Technical Support directly at 800-897-4151 (+1 937-767-7241).

When returning a product for service, include the Product Return form with cleaning certification. The form must be completely filled out for a YSI Service Center to accept the instrument for service. The form may be downloaded from [www.ysi.com](http://www.ysi.com) by clicking on the 'Support'.

## APPENDIX A-DO% CALIBRATION VALUES

Calibration Value	Pressure			
D.O. %	in Hg	mmHg	kPa	mbar
101%	30.22	767.6	102.34	1023.38
100%	29.92	760.0	101.33	1013.25
99%	29.62	752.4	100.31	1003.12
98%	29.32	744.8	99.30	992.99
97%	29.02	737.2	98.29	982.85
96%	28.72	729.6	97.27	972.72
95%	28.43	722.0	96.26	962.59
94%	28.13	714.4	95.25	952.46
93%	27.83	706.8	94.23	942.32
92%	27.53	699.2	93.22	932.19
91%	27.23	691.6	92.21	922.06
90%	26.93	684.0	91.19	911.93
89%	26.63	676.4	90.18	901.79
88%	26.33	668.8	89.17	891.66
87%	26.03	661.2	88.15	881.53
86%	25.73	653.6	87.14	871.40
85%	25.43	646.0	86.13	861.26
84%	25.13	638.4	85.11	851.13
83%	24.83	630.8	84.10	841.00
82%	24.54	623.2	83.09	830.87
81%	24.24	615.6	82.07	820.73
80%	23.94	608.0	81.06	810.60
79%	23.64	600.4	80.05	800.47
78%	23.34	592.8	79.03	790.34
77%	23.04	585.2	78.02	780.20
76%	22.74	577.6	77.01	770.07
75%	22.44	570.0	75.99	759.94
74%	22.14	562.4	74.98	749.81
73%	21.84	554.8	73.97	739.67
72%	21.54	547.2	72.95	729.54

## APPENDIX B-OXYGEN SOLUBILITY TABLE

Solubility of Oxygen in mg/L in Water Exposed to Water-Saturated Air at 760 mm Hg Pressure.

Salinity = Measure of quantity of dissolved salts in water.

Chlorinity = Measure of chloride content, by mass, of water.

$S(0/00) = 1.80655 \times \text{Chlorinity}(0/00)$

Temp °C	Chlorinity : 0 Salinity: 0	5.0 ppt 9.0 ppt	10.0 ppt 18.1 ppt	15.0 ppt 27.1 ppt	20.0 ppt 36.1 ppt	25.0 ppt 45.2 ppt
0.0	14.62	13.73	12.89	12.10	11.36	10.66
1.0	14.22	13.36	12.55	11.78	11.07	10.39
2.0	13.83	13.00	12.22	11.48	10.79	10.14
3.0	13.46	12.66	11.91	11.20	10.53	9.90
4.0	13.11	12.34	11.61	10.92	10.27	9.66
5.0	12.77	12.02	11.32	10.66	10.03	9.44
6.0	12.45	11.73	11.05	10.40	9.80	9.23
7.0	12.14	11.44	10.78	10.16	9.58	9.02
8.0	11.84	11.17	10.53	9.93	9.36	8.83
9.0	11.56	10.91	10.29	9.71	9.16	8.64
10.0	11.29	10.66	10.06	9.49	8.96	8.45
11.0	11.03	10.42	9.84	9.29	8.77	8.28
12.0	10.78	10.18	9.62	9.09	8.59	8.11
13.0	10.54	9.96	9.42	8.90	8.41	7.95
14.0	10.31	9.75	9.22	8.72	8.24	7.79
15.0	10.08	9.54	9.03	8.54	8.08	7.64
16.0	9.87	9.34	8.84	8.37	7.92	7.50
17.0	9.67	9.15	8.67	8.21	7.77	7.36
18.0	9.47	8.97	8.50	8.05	7.62	7.22
19.0	9.28	8.79	8.33	7.90	7.48	7.09
20.0	9.09	8.62	8.17	7.75	7.35	6.96
21.0	8.92	8.46	8.02	7.61	7.21	6.84
22.0	8.74	8.30	7.87	7.47	7.09	6.72
23.0	8.58	8.14	7.73	7.34	6.96	6.61
24.0	8.42	7.99	7.59	7.21	6.84	6.50
25.0	8.26	7.85	7.46	7.08	6.72	6.39

Temp °C	Chlorinity : 0 Salinity: 0	5.0 ppt 9.0 ppt	10.0 ppt 18.1 ppt	15.0 ppt 27.1 ppt	20.0 ppt 36.1 ppt	25.0 ppt 45.2 ppt
26.0	8.11	7.71	7.33	6.96	6.62	6.28
27.0	7.97	7.58	7.20	6.85	6.51	6.18
28.0	7.83	7.44	7.08	6.73	6.40	6.09
29.0	7.69	7.32	6.93	6.62	6.30	5.99
30.0	7.56	7.19	6.85	6.51	6.20	5.90
31.0	7.43	7.07	6.73	6.41	6.10	5.81
32.0	7.31	6.96	6.62	6.31	6.01	5.72
33.0	7.18	6.84	6.52	6.21	5.91	5.63
34.0	7.07	6.73	6.42	6.11	5.82	5.55
35.0	6.95	6.62	6.31	6.02	5.73	5.46
36.0	6.84	6.52	6.22	5.93	5.65	5.38
37.0	6.73	6.42	6.12	5.84	5.56	5.31
38.0	6.62	6.32	6.03	5.75	5.48	5.23
39.0	6.52	6.22	5.98	5.66	5.40	5.15
40.0	6.41	6.12	5.84	5.58	5.32	5.08
41.0	6.31	6.03	5.75	5.49	5.24	5.01
42.0	6.21	5.93	5.67	5.41	5.17	4.93
43.0	6.12	5.84	5.58	5.33	5.09	4.86
44.0	6.02	5.75	5.50	5.25	5.02	4.79
45.0	5.93	5.67	5.41	5.17	4.94	4.72

Item # 605056  
Rev C  
Drawing # A605056  
November 2010

©2010 YSI Incorporated.





## STANDARD OPERATING PROCEDURE

### MAINE VOLUNTEER RIVER MONITORING PROGRAM

#### METHODS FOR USING THE EXTECH PORTABLE SALINITY REFRACTOMETER (MODEL RF20) WITH ATC (AUTOMATIC TEMPERATURE COMPENSATION)



**Note:** The mention of brand names does not constitute recommendation of a specific company.



## Volunteer River Monitoring Program

### Standard Operating Procedure Methods for using the Extech Portable Salinity Refractometer (Model RF20) for Measuring Salinity in Rivers and Streams

**1. Applicability.** This standard operating procedure (SOP) is used by the Volunteer River Monitoring Program (VRMP) of the Maine Department of Environmental Protection's Division of Environmental Protection. It applies to the collection of salinity using an Extech Portable Salinity Refractometer (RF20) by volunteers from rivers and streams in Maine.

**2. Purpose.** The purpose of this SOP is to provide standardized methods for volunteer groups to determine salinity of rivers and streams as an instantaneous reading using the Extech Portable Salinity Refractometer (RF20).

#### 3. Definitions.

**A. Extech.** Manufacturer of handheld instruments.

**B. Distilled Water.** Water that has many of its impurities removed through distillation.

**C. PPT.** Parts per thousand.

**C. Salinity.** Salinity is a measure of the total amount of dissolved salts in a sample. Sodium and chloride are the predominant ions in seawater, and other substantial ions include magnesium, calcium and sulfates. Salinity is an important factor in determining many aspects of the chemistry of natural waters and biological processes. In marine waters, salinity affects dissolved oxygen and will need to be measured separately in order to accurately calibrate the meter, if the particular dissolved oxygen meter does not directly measure salinity. Salinity may be expressed in a number of ways, parts per thousand and parts per million are the two most common measurements, and it is sometimes expressed as a percentage as well.

#### 4. Responsibilities.

##### *A. Volunteer Monitors & Volunteer Groups*

- **Certification.** It is the responsibility of the individual obtaining this data to maintain current certification for the parameter(s) they collect if they wish their data to be entered into the VRMP database. Training will be provided to volunteers on an annual basis by VRMP/DEP staff, and certification will last for one year from the date of training.



- **Data recording.** It is the responsibility of the individual obtaining this data to record the results and additional qualifying information on current field sheets obtained from their affiliated watershed association or through the VRMP program of the DEP.
- **Data Quality Checks and Data Submission.** The data manager for the volunteer group will collect and enter volunteer field sheet data onto the appropriate computer file, perform quality assurance checks (refer to Section 5.10 of the Quality Assurance Program Plan), and submit data to the VRMP following protocols outlined in the volunteer group's latest sampling and analysis plan (SAP) that has been approved by the VRMP.

### ***B. Volunteer River Monitoring Program (VRMP) Staff***

- **Oversight of Volunteer Groups and Volunteers.** VRMP staff will oversee volunteer groups and volunteers through a variety of ways including maintaining an up-to-date VRMP quality assurance project plan (QAPP); reviewing sampling and analysis plans (SAPs) of the volunteer groups; providing annual training/certification sessions for volunteers; conducting quality assurance checks on data submitted by volunteer groups and laboratories; and uploading data into the DEP's EGAD database. These tasks are described in greater detail in the VRMP's latest QAPP.

## **5. Guidelines and Procedures.**

### ***A. Salinity Measurements.***

- **Sampling period and location.** Sampling period and site location information will be documented in volunteer groups' SAPs (that require approval by the VRMP) which are submitted by the volunteer groups prior to the beginning of a sampling season. (Detailed information regarding how volunteer groups are to obtain and document site location information can be found in VRMP SOP-02 [Documenting Site Location].)
- **Familiarize Yourself With the Refractometer.** Volunteers shall familiarize themselves with the basic operation of the refractometer (Appendix A; "Operation").
- **Reading Selection.** Readings shall be recorded as parts per thousand.
- **General Sampling Protocol.** (Refer to Appendix A, section "Operation").
  - (1) Record site location on data sheet.
  - (2) Perform a zero adjustment with distilled water. Place sample on the measurement prism, ensuring that the sample covers the prism. Allow the sample to remain on the prism for approximately 30 seconds. Record reading in parts per thousand.
  - (3) Wipe dry with a clean cloth (do not wash or rinse). Place the instrument in its supplied plastic case.



• **Quality Control**

- (1) At the beginning of each field season, all VRMP staff and VRMP volunteers who will collect salinity data will have a training/refresher session to (re)familiarize themselves with the contents of this SOP.
- (2) For every volunteer, a field duplicate shall be obtained for all parameters for at least 10% of their own sampling efforts. A field duplicate will be collected for every 10 samples monitored.
- (3) Refer to the VRMP quality assurance project plan (QAPP) for more QA/QC details.

**6. Equipment Care.**

**A. Start of field season.**

1. Inspect the instrument for damage.
2. Each refractometer “setup” should include the following items:
  - a. Field datasheet
  - b. User guide
  - c. Distilled water
  - d. Pipet (for sample)
  - e. Screwdriver (for rotating the adjustment screw)

**B. Field Season.**

1. Handle the refractometer gently and avoid touching the optical surface.
2. Clean only with the supplied soft cloth.
3. Refractometer should be kept in the supplied plastic case.
4. Store in a safe, dry environment.

**C. End of field season (also see Appendix A, section “Electrode Maintenance”).**

1. Store in a safe, dry environment.

**D. Miscellaneous.** The Extech Salinity Refractometer (Model RF20) has automatic temperature compensation. When ambient temperature varies from 68°F (20°C), readings are automatically adjusted to compensate for temperature variance between 50°F to 86°F (10°C to 30°C).

**7. Specifications**

Scale	Range	Resolution
Parts Per Thousand	0 to 100 ‰	1 ‰
Specific Gravity	1.000 to 1.070 d <sup>20</sup> / <sub>20</sub>	0.001 d <sup>20</sup> / <sub>20</sub>



## 8. Appendix.

### A. Refractometer owner's manual:

Extech. March 2015. Extech Instruments User Guide: Portable Salinity Refractometer with ATC-Model RF20. [RF20-en-US-v2.4 3/15]. Extech Instruments, New Hampshire.

## 9. References.

### A. *Maine VRMP QAPP:*

- Maine Department of Environmental Protection (MDEP). 2020. Maine Volunteer River Monitoring Program (VRMP) Quality Assurance Program Plan (QAPP). DEPLW-0984.

**Portable Salinity Refractometer with ATC**

**Model RF20**

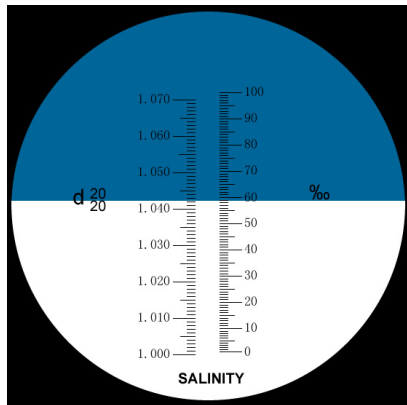
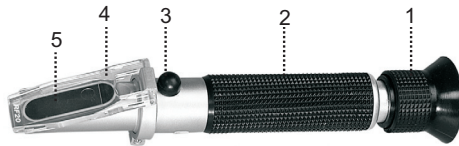


**Introduction**

Congratulations on your purchase of the Extech RF20 Handheld Salinity Refractometer with Automatic Temperature Compensation. Precision optical instruments should be handled gently; avoid touching the optical surface. Careful use of this instrument will provide years of reliable service.

**Description**

1. Eyepiece
2. Mirror tube
3. Adjust screw
4. Cover plate
5. Prism



Field of view

**Operation**

The instrument measures the refractive index of the sample and displays the result in parts per thousand ( $^0/_{00}$ ) and specific gravity ( $d^{20}/_{20}$ ).

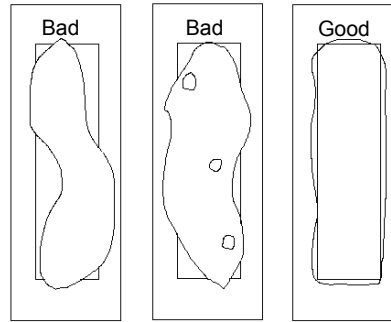
**1. Zero Adjustment**

Cover the prism with a few drops of distilled water from the included vial. Close the cover plate and rotate the adjusting screw so that the light/dark boundary line (known as the shadow-line) evens up with the zero line. After the zero adjustment, clean the prism with soft cloth.

**2. Sample Preparation and Measurement Readings**

To take a reading, place a few drops of a sample liquid on the measurement prism. Ensure that enough solution is added to the prism in order to cover the entire prism. Close the prism so that the liquid spreads across the entire surface of the prism without air bubbles or dry spots (see diagrams below). Allow the sample to remain on the prism for approximately 30 seconds.

While holding the instrument under a light source, look through the eyepiece. The salinity concentration is determined by the intersection of the boundary of the light and dark fields (known as the shadow-line) on the printed scale. The left side of the scale indicates the specific gravity and the right side parts per thousand. If the scale appears out of focus, the eyepiece may be adjusted by rotating the knurled portion. The instrument also features an eye guard to prevent stray light from entering the eyepiece and causing reflections.



It may be necessary to adjust the position of the light source to maximize the contrast of the shadow-line. Under normal conditions, optimal contrast is obtained by holding the instrument underneath and perpendicular to a light source. Once a reading has been taken, wipe dry with a clean cloth (do not wash or rinse) and place the instrument in the supplied plastic case. Store the instrument in a safe, dry environment.

Once a reading has been taken, wipe dry with a clean cloth (do not wash or rinse) and place the instrument in the supplied plastic case. Store the instrument in a safe, dry environment.

Once a reading has been taken, wipe dry with a clean cloth (do not wash or rinse) and place the instrument in the supplied plastic case. Store the instrument in a safe, dry environment.

**3. Automatic Temperature Control (ATC)**

Temperature is the single most important factor influencing refractometer readings and is one of the largest sources of measurement error. However, this device incorporates automatic temperature compensation and the concern for temperature fluctuations in sample liquids is alleviated. When ambient temperature varies from 68°F (20°C), readings are automatically adjusted to compensate for temperature variance between 50°F to 86°F (10°C to 30°C).

**Specifications**

Scale	Range	Resolution
Parts Per Thousand	0 to 100 $^0/_{00}$	1 $^0/_{00}$
Specific Gravity	1.000 to 1.070 $d^{20}/_{20}$	0.001 $d^{20}/_{20}$

Dimensions: 7.6 x 1.5 x 1.5" (194 x 38 x 38mm)

Weight: Approx. 8.0 oz. (227g)

**Calibration and Repair Services**

FLIR Systems, Inc. offers repair and calibration services for the Extech Instruments products we sell. NIST certification for most products is also provided. Call the Customer Service Department for information on calibration services available for this product. Annual calibrations should be performed to verify meter performance and accuracy. Technical support and general customer service is also provided, refer to the contact information provided below.

**Warranty**

*FLIR Systems, Inc. warrants this Extech Instruments brand device to be free of defects in parts and workmanship for one year from date of shipment (a six month limited warranty applies to sensors and cables). If it should become necessary to return the instrument for service during or beyond the warranty period, contact the Customer Service Department for authorization. Visit the website [www.extech.com](http://www.extech.com) for contact information. A Return Authorization (RA) number must be issued before any product is returned. The sender is responsible for shipping charges, freight, insurance and proper packaging to prevent damage in transit. This warranty does not apply to defects resulting from action of the user such as misuse, improper wiring, operation outside of specification, improper maintenance or repair, or unauthorized modification. FLIR Systems, Inc. specifically disclaims any implied warranties or merchantability or fitness for a specific purpose and will not be liable for any direct, indirect, incidental or consequential damages. FLIR's total liability is limited to repair or replacement of the product. The warranty set forth above is inclusive and no other warranty, whether written or oral, is expressed or implied.*

**Support Lines: U.S. (877) 439-8324; International: +1 (603) 324-7800**

Technical Support: Option 3; E-mail: [support@extech.com](mailto:support@extech.com)

Repair & Returns: Option 4; E-mail: [repair@extech.com](mailto:repair@extech.com)

Product specifications are subject to change without notice

**Please visit our website for the most up-to-date information**

[www.extech.com](http://www.extech.com)

FLIR Commercial Systems, Inc., 9 Townsend West, Nashua, NH 03063 USA

**ISO 9001 Certified**

**Copyright © 2013-2015 FLIR Systems, Inc.**

All rights reserved including the right of reproduction in whole or in part in any form

[www.extech.com](http://www.extech.com)



## **STANDARD OPERATING PROCEDURE MAINE VOLUNTEER RIVER MONITORING PROGRAM**

### **METHODS FOR USING THE YSI ECOSENSE EC 300A PORTABLE CONDUCTIVITY, SALINITY AND TEMPERATURE INSTRUMENT**



Note: The mention of brand does not constitute recommendation of a specific company.



## Volunteer River Monitoring Program (VRMP)

### Standard Operating Procedure

#### Methods for using the YSI EcoSense 300A Portable Conductivity, Salinity and Temperature Instrument

- 1. Applicability.** This standard operating procedure (SOP) is used by the Volunteer River Monitoring Program (VRMP) of the Maine Department of Environmental Protection's Division of Watershed Management. It applies to the collection of conductivity, salinity and temperature from rivers and streams in Maine using the YSI EcoSense 300A handheld meter.
- 2. Purpose.** This purpose of this SOP is to provide standardized methods for volunteer groups to determine conductivity, salinity and temperature of rivers and streams by volunteers as an instantaneous reading using the YSI EcoSense EC300A Portable Conductivity, Salinity and Temperature Instrument. (*Note:* This instrument is also capable of measuring TDS (total dissolved solids). TDS is determined by multiplying conductivity by a TDS factor.)
- 3. Definitions.**
  - A. YSI.** Yellow Springs International, manufacturer of water quality monitoring meters.
  - B. Temperature Compensated Conductivity.** Measurement of conductivity compensated to 25 °C or another specified value between 15 and 25 °C. It is expressed as  $\mu\text{S}/\text{cm}$  or  $\text{mS}/\text{cm}$  with a flashing "°C".
  - C. Uncompensated Conductivity.** Direct measurement of conductivity, not compensated to a specific temperature. It is expressed as  $\mu\text{S}/\text{cm}$  or  $\text{mS}/\text{cm}$ .
  - D. Specific Conductance.** Specific conductance is electrical conductivity (EC) that is being expressed in microsiemens per centimeter ( $\mu\text{S}/\text{cm}$ ) at a normalized temperature of 25 °C. Specific conductance is related to the type and concentration of ions in solution and can be used for approximating the dissolved-solids content of the water. Commonly, the concentration of dissolved solids (in  $\text{mg}/\text{L}$ ) is about 65% of the specific conductance (in microsiemens). (*Note:* This relation is not constant from stream to stream, and it may vary in the same stream with changes in the composition of the water.)
  - E. Salinity.** Salinity is a measure of the total amount of dissolved salts in a sample. Sodium and chloride are the predominant ions in seawater, and other substantial ions include magnesium, calcium and sulfates. Salinity is an important factor in determining many aspects of the chemistry of natural waters and biological processes. In marine waters, salinity affects dissolved oxygen and will need to be measured separately in order to accurately calibrate the meter, if the particular dissolved oxygen meter does not directly measure salinity. Salinity may be expressed in a number of ways, parts per thousand and





parts per million are the two most common measurements, and it is sometimes expressed as a percentage as well.

**F. Total Dissolved Solids (TDS).** In stream water, dissolved solids consist of calcium, chlorides, nitrates, phosphorus, iron, sulfur, and other ion particles that will pass through a filter with pores of around 2 microns (0.002 cm) in size. TDS is calculated by converting the electrical conductivity by a factor of 0.5 to 1.0 times the EC.

**G. Electrode.** Sensing device located at the end of a cable that is attached to the meter.

**H. Calibration.** Set of procedures established by the manufacturer to ensure the meter is operating properly: a critical quality assurance step in meter preparation prior to use.

#### 4. Responsibilities.

##### *A. Volunteer Monitors & Volunteer Groups*

- **Certification.** It is the responsibility of the individual obtaining this data to maintain current certification for the parameter(s) they collect if they wish their data to be entered into the VRMP database. Training will be provided to volunteers on an annual basis by VRMP/DEP staff, and certification will last for one year from the date of training.
- **Data Recording.** It is the responsibility of the individual obtaining this data to record the results and additional qualifying information on current field sheets obtained from their affiliated watershed association or through the VRMP program of the DEP.
- **Data Quality Checks and Data Submission.** The data manager for the volunteer group will collect and enter volunteer field sheet data onto the appropriate computer file, perform quality assurance checks (Refer to Section 5.10 of the Quality Assurance Program Plan), and submit data to the VRMP following protocols outlined in the volunteer group's latest sampling and analysis plan (SAP) that has been approved by the VRMP.

##### *B. Volunteer River Monitoring Program (VRMP) Staff*

- **Oversight of Volunteer Groups and Volunteers.** VRMP staff will oversee volunteer groups and volunteers through a variety of ways including maintaining an up-to-date VRMP quality assurance program plan (QAPP); reviewing sampling and analysis plans (SAPs) of the volunteer groups; providing annual training/certification sessions for volunteers; conducting quality assurance checks on data submitted by



volunteer groups and laboratories; and uploading data into the DEP's EGAD database. These tasks are described in greater detail in the VRMP's latest QAPP.

## **5. Guidelines and Procedures.**

### **A. Meter Preparation.**

1. Before each field season, conduct a full inspection of the meter. New batteries shall be installed at the start of the sampling season and additionally, as needed. In addition, follow manufacturer's instructions for maintenance. (Refer to manual; section "Probe Maintenance").
2. Each meter should be equipped with:
  - Manual or copy of manual
  - Field record book/card for recording QA and repairs
  - Extra battery
  - Screw top containers for sample collection and di-ionized water
3. Conductivity standards should be obtained for calibration. Generally standards of 100, 500, and 1000 ( $\mu\text{s}/\text{cm}$ ) should cover the range of streams sampled.
4. The meter should be kept as dry as possible. Ideally, the meter should be stored in a water resistant case with padding to protect it from damage.

### **B. Calibration.**

1. Meter calibration is a necessary step that must be undertaken to assure that readings are accurate.
2. The EcoSense EC300A meter shall be calibrated at the beginning of the field season and then as needed. The meter should be calibrated to a known standard, preferably in the middle range of solutions that will be sampled.
3. Ideally, the calibration should be undertaken in the lab prior to going out to sample as the meter and conductivity solutions will be close to 25 °C.
4. Calibrate the meter according to manufacturer's instructions. (Refer to manual: Section "Calibration").
5. If possible, periodically cross check the meter with other Division of Environmental Assessment meters.
6. Record calibration checks on the field record book/card.

### **C. Conductivity, Salinity and Temperature Measurements.**

1. The team leader shall familiarize themselves with the basic operation, keypad and readouts of the meter. Refer to manual: Section "Key Functions of the Model EC300A" through "Measurement Modes" and Section "Conductivity Measurements".
2. When taking measurements, ensure that the probe is submerged and temperature has stabilized before recording the measurement.



3. Measurements may either be made directly in the stream or a clean sample container. “Clean” means that the sample container has been rinsed 3 times with stream water at the site.
4. Relevant information such as weather, samplers, meter #, date/time, GPS location should be recorded on the sampling sheet in addition to the conductivity, salinity, temperature measurements.
5. If the sampling location has an overall depth of less than 1 meter, sampling is taken at mid-depth. If depth is greater than 1 meter in depth, sample at mid-depth if known or ½ foot below surface.

## **6. Equipment Care.**

### **A. Start of field season.**

1. Follow manufacturer's directions for preparation of a new electrode at the start of the field season.
2. Use new batteries at start of each sampling season. An extra set of appropriate size batteries (1 9V batteries) should be included in the meter carrying case.

### **B. Field Season.**

1. Always keep the sensor electrodes clean. Rinse the electrode with de-ionized water and wipe it dry with a clean cloth before storing with protective cap.
2. Ideally the meter should be in water-resistant case with padding to protect it from damage.
3. Allow the case and contents to air-dry at end of each day. This may be accomplished by simply propping lid open. When contents are very wet, remove the contents and spread out to facilitate drying.
4. Do not store the meter in extreme environments (eg. car over hot summer periods).
5. Replace battery if low battery indicated.
6. The instrument is waterproof, however if it is submerged without the cap connected, follow manufacturer’s instructions immediately. See manual: Section “The Instrument”.

### **C. End of field season.**

1. Completely dry meter, case, and all items in the case before storing.
2. Remove battery.
3. Soak electrode in alcohol for a 10-15 minutes to remove oils (not sure about this?)
4. Cover top of electrode with electrode cap to keep dust and dirt out for winter.
5. Keep meter dry and in a heated storage space to prevent corrosion of electronic parts.
6. Record winterization date and equipment repairs in Equipment Log.
7. Label the meter and case as ‘WINTERIZED’ in an obvious manner (so users will know the current status of the unit).



8. Send the meter for repair if needed.

**D. Miscellaneous.** Refer to Appendix A: “Troubleshooting”, if instrument fails to calibrate or displays “OvEr/Undr”.

**7. Specifications**

Display	Range	Accuracy	Resolution
Conductivity, Auto-ranging	0.0 to 499.9 $\mu\text{S}/\text{cm}$	$\pm 1\%$ of reading plus 2 $\mu\text{S}/\text{cm}$	0.01 $\mu\text{S}/\text{cm}$
	500 to 4999 $\mu\text{S}/\text{cm}$	$\pm 1\%$ of reading plus 5 $\mu\text{S}/\text{cm}$	1 $\mu\text{S}/\text{cm}$
	5.00 to 49.99 $\text{mS}/\text{cm}$	$\pm 1\%$ of reading plus 0.05 $\text{mS}/\text{cm}$	0.01 $\text{mS}/\text{cm}$
	50.0 to 200.0 $\text{mS}/\text{cm}$	$\pm 2.5\%$ of reading plus 0.5 $\text{mS}/\text{cm}$	0.1 $\text{mS}/\text{cm}$
Salinity	0.0 to 70.0 ppt	0.2% Full Scale	0.1 ppt
Temperature	-10.0 to 90 $^{\circ}\text{C}$	$\pm 0.2^{\circ}\text{C}$ or $\pm 0.4\%$ Full Scale whichever is greater	0.1 $^{\circ}\text{C}$

**8. Appendix**

**A. YSI Meter owner’s manual:**

YSI Incorporated. July 2012. Operations Manual EcoSense EC300A Portable Conductivity, Salinity, and Temperature Instrument. Yellow Springs, Ohio.

**9. References.**

**A. DEP Standard Operating Procedures:**

- Document number #:DEPLW-0890: Dissolved Oxygen and Temperature, Instantaneous Measurement using Electronic Meters
- Document number#: DEPLW-0984: Methods for Using the Oakton Waterproof ECTestr for Measuring Specific Conductance in Rivers and Streams

**B. Maine VRMP QAPP:**

- Maine Department of Environmental Protection (MDEP). 2020. Maine Volunteer River Monitoring Program (VRMP) Quality Assurance Program Plan (VRMP). DEPLW-0984.

# Operations Manual EcoSense® EC300A

Portable  
Conductivity, Salinity  
and Temperature  
Instrument



- English
- Français
- Español
- Português



## **WARRANTY**

The EcoSense® EC300A Instrument is warranted for one year from date of purchase by the end user against defects in materials and workmanship. EC300A probes and cables are warranted for one year from date of purchase by the end user against defects in material and workmanship. Within the warranty period, YSI will repair or replace, at its sole discretion, free of charge, any product that YSI determines to be covered by this warranty.

To exercise this warranty, write or call your local YSI representative, or contact YSI Customer Service in Yellow Springs, Ohio. Send the product and proof of purchase, transportation prepaid, to the Authorized Service Center selected by YSI. Repair or replacement will be made and the product returned, transportation prepaid. Repaired or replaced products are warranted for the balance of the original warranty period, or at least 90 days from date of repair or replacement.

### **Limitation of Warranty**

This Warranty does not apply to any YSI product damage or failure caused by: (i) failure to install, operate or use the product in accordance with YSI's written instructions; (ii) abuse or misuse of the product; (iii) failure to maintain the product in accordance with YSI's written instructions or standard industry procedure; (iv) any improper repairs to the product; (v) use by you of defective or improper components or parts in servicing or repairing the product; or (vi) modification of the product in any way not expressly authorized by YSI.

THIS WARRANTY IS IN LIEU OF ALL OTHER WARRANTIES, EXPRESSED OR IMPLIED, INCLUDING ANY WARRANTY OF MERCHANTABILITY OR FITNESS FOR A PARTICULAR PURPOSE. YSI's LIABILITY UNDER THIS WARRANTY IS LIMITED TO REPAIR OR REPLACEMENT OF THE PRODUCT, AND THIS SHALL BE YOUR SOLE AND EXCLUSIVE REMEDY FOR ANY DEFECTIVE PRODUCT COVERED BY THIS WARRANTY. IN NO EVENT SHALL YSI BE LIABLE FOR ANY SPECIAL, INDIRECT, INCIDENTAL OR CONSEQUENTIAL DAMAGES RESULTING FROM ANY DEFECTIVE PRODUCT COVERED BY THIS WARRANTY.

## **CONTACT INFORMATION**

YSI Inc.  
1725 Brannum Lane  
Yellow Springs OH, 45387  
Tel: 800-897-4151; 937-767-7241  
Fax: 937-767-1058  
Email: [environmental@ysi.com](mailto:environmental@ysi.com)  
Website: [www.ysi.com](http://www.ysi.com)

## CONTENTS

WARRANTY.....	1
CONTACT INFORMATION.....	1
GENERAL INTRODUCTION.....	3
INITIAL INSPECTION.....	3
THE INSTRUMENT.....	3
BATTERY INSTALLATION.....	3
Battery Disposal.....	3
KEY FUNCTIONS OF THE MODEL EC300A.....	4
THE LCD DISPLAY.....	4
MEASUREMENT MODES.....	4
CALIBRATION.....	5
TDS.....	5
CELL.....	5
Temperature Coefficient.....	5
Temperature Reference.....	5
Conductivity Calibration.....	5
CONDUCTIVITY MEASUREMENTS.....	6
SAVING, VIEWING AND DELETING DATA.....	6
PROBE MAINTENANCE.....	6
TROUBLESHOOTING.....	7
SPECIFICATIONS.....	8
RECOMMENDED SPARE PARTS LIST.....	8



## **GENERAL INTRODUCTION**

The EC300A is a precision tool that measures conductivity, salinity and temperature. A built-in microprocessor calculates and compensates for all parameters related to conductivity and temperature determinations.

This instrument is waterproof (IP67) when the connector cap is installed. The mechanical touch keys are highly reliable with tactile and audio feedback. This instrument uses one 9V battery. Re-calibration is not required when power is restored.

The front of the instrument has a large LCD that displays temperature and either temperature compensated or non-temperature compensated conductivity, salinity or TDS simultaneously along with user prompts and mode indicators. The unit prompts users through calibration and measurement procedures.

The model EC300A is available with a single four-electrode cell. Other features include automatic conductivity ranging, automatic temperature compensation, long battery life, and 50/60 Hz AC noise rejection. This meter is universal and user-friendly for field, industrial and laboratory applications.

## **INITIAL INSPECTION**

Carefully unpack the unit and accessories, and inspect for shipping damages. Compare received parts with materials listed on the packing list. Notify YSI immediately of any damage or missing parts. Save all packing materials until satisfactory operation is confirmed.

## **THE INSTRUMENT**

Though the instrument is housed in a water-proof IP67 case, DO NOT use it underwater. The connector is not waterproof unless the cap is installed. In case of submersion without the cap connected, follow these steps immediately:

1. Dry the connector if necessary, and replace the conductivity probe. Rinse unit carefully with distilled water. After rinsing and drying, inspect and clean connectors to remove all contaminants that may affect probe connections.
2. Wait for the unit and probe to dry completely before resuming operation.
3. If the unit does not function correctly after steps 1 and 2, call YSI for possible repair or replacement (see Warranty).

## **BATTERY INSTALLATION**

An initial display of "BAT" on the LCD indicates approximately one hour of battery life for unit operation within specifications. Replace battery when "BAT" appears on the LCD. (See Figure 1.)

To replace battery, remove the two battery cover screws, battery cover and o-ring. Replace the 9V battery. Replace battery cover and o-ring (align the o-ring properly to insure a good seal) and fasten the two battery cover screws for the splash-resistant feature.

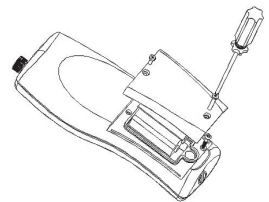


Figure 1.  
Battery Installation

## **Battery Disposal**

This instrument is powered by a 9 volt battery, which the user must remove and dispose of when the batteries no longer power the instrument. Disposal requirements vary by country and region, and users are expected to understand and follow the battery disposal requirements for their specific locale.

## KEY FUNCTIONS OF THE MODEL EC300A

1. **Power**: Turns the unit ON or OFF. Calibration values are not erased when the unit is turned off. When the unit is not in use, turn it off to save battery life. The instrument has a 30 minute auto shut off feature when not in use. For long-term storage, remove the battery.
2. **MODE**: Selects display mode. In Normal operation, press MODE to switch the display between uncompensated conductivity, temperature compensated conductivity, salinity, total dissolved solids (TDS), Recall and Delete. In calibration mode, this key exits the current calibration and displays the next calibration parameter.
3. **CAL**: In normal operation, changes the mode from Normal to Calibration.
4. **Enter**: In Calibration Set-up, press this key to save the current parameter to memory.
5. **Δ and ∇ Keys**: Increases or decreases the display value as desired.

## THE LCD DISPLAY

1. **CONDUCTIVITY**: Displays when measuring conductivity.
2. **BAT**: Low battery indicator.
3. **CELL**: Indicates conductivity cell constant value.
4. Main display for compensated and uncompensated conductivity, salinity and TDS values.
5. **TDS**: Displays when measuring total dissolved solids.

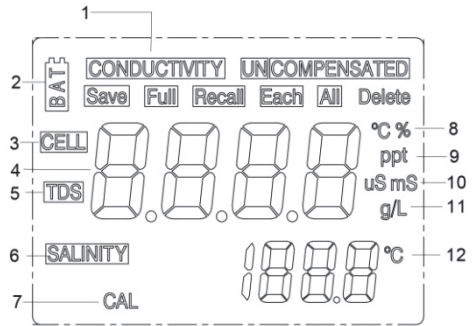


Figure 1. LCD Display

6. **SALINITY**: Displays when measuring salinity.
7. **CAL**: Calibration mode indicator.
8. **°C**: Flashes during temperature compensated conductivity measurement. During calibration, indicates temperature reference unit.
- %**: Displays during calibration; indicates temperature coefficient unit.
9. **ppt**: Parts per thousand; indicates salinity measurement.
10. **uS, mS**: micro Siemens, milli Siemens; Indicates conductivity measurement.
11. **g/L**: grams/Liter; indicates TDS measurement.
12. **°C**: Temperature display.

## MEASUREMENT MODES


1. **Temperature** - Current solution temperature continually displays.
2. **Temperature Compensated Conductivity** - Measurement of conductivity, compensated to 25°C or another specified value between 15 and 25°C. Expressed as uS/cm or mS/cm with a flashing "°C".
3. **Uncompensated Conductivity** - Direct measurement of conductivity, not compensated to a specific temperature. Expressed as uS/cm or mS/cm.
4. **Salinity** - Measurement of salinity; expressed in parts per thousand (ppt).

5. **TDS** - Measurement of total dissolved solids (TDS); expressed in grams per liter (g/L). Carefully observe the units displayed at the far side of the LCD to determine the desired mode.


## **CALIBRATION**

Calibration setup contains five sections: TDS, Cell, Temperature Coefficient, Temperature reference, and Conductivity Calibration. To access these sections:


1. Connect the conductivity probe and cable assembly to the unit and turn the unit on. The screen will display **CELL** and the cell constant of the conductivity probe.
2. Allow temperature readings to stabilize, then press **CAL** to enter the calibration mode; **CAL** appears on the LCD. Press **MODE** to sequentially display the following sections:


**Note:** Press Enter (  ) to accept any values changes in each section and automatically advance to the next section. If there are no changes, the unit accepts the current value and proceeds to the next section.

### **TDS**


TDS is determined by multiplying conductivity (mS) by a TDS factor. The default factor value is 0.65. To change the TDS factor, use the **Δ** and **∇** keys to adjust the value between 0.30 and 1.00. Press Enter (  ) to save the new value, or press **MODE** to cancel the change and display the **CELL** screen.

### **CELL**


The second screen will display **CELL** and the current cell value. The default cell value is 5.00 and is displayed in the lower right of the screen. The unit allows a variance of  $\pm 0.50$  before displaying an error message. The cell value cannot be adjusted at this screen; calibrating conductivity is the only way to adjust the cell constant. Press Enter (  ) to reset the cell constant to 5.00 and display the **Temperature Coefficient** screen.

**Note:** Be certain to press Enter (  ) to reset the cell constant to 5.00. If **MODE** is pressed, the unit retains the previous cell constant and calibrates from a value that is already offset.

### **Temperature Coefficient**

The unit uses the temperature coefficient to calculate temperature compensated conductivity. The default value is 1.91%. To change the temperature coefficient, use the **Δ** and **∇** keys to adjust the value between 0 and 4.00%. Press Enter (  ) to save the new value, or press **MODE** to cancel the change and display the **Temperature Reference** screen.

### **Temperature Reference**

The unit uses the temperature reference value to calculate temperature compensated conductivity. The default value is 25°C. To change the temperature coefficient, use the **Δ** and **∇** keys to adjust the value between 15 and 25°C. Press Enter (  ) to save the new value, or press **MODE** to cancel the change and display the **Conductivity Calibration** screen.

### **Conductivity Calibration**

1. Immerse the probe in a standard of known conductivity, preferably a standard in the middle range of the solutions to be measured. Completely submerge the probe without touching the sides of the calibration container. Shake the probe lightly to remove any air bubbles trapped in the conductivity cell.

2. Allow temperature to stabilize. The message 'rAng' (range) may display briefly to indicate unit auto-ranging; this is normal. After temperature stabilization, use the  $\Delta$  and  $\nabla$  keys to adjust the conductivity value to that of the conductivity standard at 25°C. Press Enter ( $\blacktriangleright$ ) to calibrate. The unit beeps twice to indicate a successful calibration, then automatically switches to normal operation mode.

## CONDUCTIVITY MEASUREMENTS

1. Turn the unit on. Place the probe in the solution to be measured. Completely submerge the probe. Shake the probe lightly to remove any trapped air bubbles in the conductivity cell.
2. Press **MODE** to enter the desired measurement mode. The message 'rAng' (range) may appear briefly on the display indicate auto-ranging; this is normal. Allow temperature to stabilize before taking measurements.

## SAVING, VIEWING AND DELETING DATA

The EC300A can save 50 data records. When in measurement mode, press  $\blackleftarrow$  to save a record. The instrument will confirm the saved data by displaying SAVE and the record number for one second. "Full" is displayed when trying to save data and the memory is full.

To view saved data, press mode until RECALL is displayed and then press  $\blackleftarrow$ . Use the Up or Down arrow keys to review different saved records. Press Mode to escape back to measurement mode.

To delete data records, press Mode while in measurement mode until DELETE is displayed. Press  $\blackleftarrow$ . "All" will be displayed and blinking. Press the Up or Down arrow key to switch between delete 'All' or 'Each' options. Select either 'All' or 'Each' by pressing  $\blackleftarrow$  while that option is displayed.

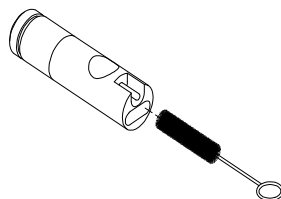
If 'All' is selected, all records will be deleted from memory and 'None' will be displayed. Press Mode twice to return to the measurement mode.

If 'Each' is selected, the Up and Down arrow keys will allow you to scroll through the saved data records. Press  $\blackleftarrow$  to delete the selected record. All records after the deleted record will shift up to keep the records in sequential order. For example, if record 3 is deleted, record 4 will become record 3 and record 5 will become record 4. Press Mode twice to return to the measurement mode.

## PROBE MAINTENANCE

The most important requirement for accurate and reproducible conductivity measurements is a clean cell. A dirty cell changes the conductivity of a solution through contamination. Clean the cell thoroughly before storing it. To clean the conductivity cell:

1. Dip the cell in cleaning solution and agitate for two to three minutes. Any foaming acid tile cleaner, such as Dow Chemical Bathroom Cleaner, should clean adequately. For a stronger cleaner, use a solution of 1:1 isopropyl alcohol and 1 N HCl. Remove the cell from the cleaning solution.
2. Use the nylon brush (supplied) to dislodge any contaminants from inside the electrode chamber.



Repeat steps one and two until the cell is completely clean. Rinse the cell thoroughly in deionized, or clean tap water.

## TROUBLESHOOTING

MAIN DISPLAY		PROBLEM	POSSIBLE SOLUTION
OvEr		<ul style="list-style-type: none"> <li>• Conductivity is &gt;200.0 mS</li> <li>• Salinity is &gt; 70.00 ppt</li> </ul>	<ul style="list-style-type: none"> <li>• Completely submerge the probe.</li> <li>• Allow sufficient time for the electrode and Temp probe stabilization.</li> </ul>
OvEr/Undr during calibration		<ul style="list-style-type: none"> <li>• Cell Constant Calibration is out of range</li> </ul>	<ul style="list-style-type: none"> <li>• Recalibrate with correct value for the conductivity standard.</li> <li>• Replace conductivity standard.</li> <li>• Clean cell.</li> <li>• Return for service.</li> </ul>
MAIN DISPLAY	SECONDARY DISPLAY		
OvEr/Undr	<hr/> OvEr <hr/> Undr	<hr/> Temperature >90.0 °C <hr/> Temperature < -10.0 °C	<ul style="list-style-type: none"> <li>• Decrease/Increase the sample temperature.</li> <li>• Return for service.</li> </ul>

## SPECIFICATIONS

Display	Range	Accuracy	Resolution
Conductivity, Auto-ranging	0.0 to 499.9 uS/cm 500 to 4999 uS/cm 5.00 to 49.99 mS/cm 50.0 to 200.0 mS/cm	±1% of reading plus 2 uS/cm ±1% of reading plus 5 uS/cm ±1% of reading plus 0.05 uS/cm ±2.5% of reading plus 0.5 mS/cm	0.01 uS/cm 1 mS/cm 0.01 mS/cm 0.1 mS/cm
Salinity	0.0 to 70.0 ppt	0.2% Full Scale	0.1 ppt
Temperature °C	-10.0 to 90 °C	±0.2 °C or ±0.4% Full Scale, whichever is greater	0.1 °C

Reference Temperature	15.0 to 25.0 °C
Temperature Coefficient	0.0% to 4.0%
Cell Constant	5.00 ± 0.50
TDS Constant Range	0.30 to 1.00
Power/Battery life	One 9V battery Approximately 500 hour
Calibration Back-up	Yes
Audio Feedback	Yes, on all touch keys
Instrument Case	Waterproof when connector cap installed, IP 67
Operating Temp. Range	0 to 50 °C
Operating Relative Humidity Range	up to 95%
Temperature Probe	Thermistor, 10kΩ / 25 °C
Dimensions (L x W x H)	18.7 cm x 7.6 cm x 3.8 cm (7.37 in x 3 in x 1.5 in)
Weight (batteries included)	270 grams (.6 lb)

## RECOMMENDED SPARE PARTS LIST

PART #	DESCRIPTION
300-1	1-meter probe and cable assembly
300-4	4-meter probe and cable assembly.
300-10	10-meter probe and cable assembly.
606043	Carrying case, hard sided.
485	Carrying case, soft sided.

Item #606042REF

Revision A, July 2012

For the latest version of this manual, visit [www.ysi.com](http://www.ysi.com)

Item #606042REF

Revision A; July 2012

For the latest version of this manual,  
visit [www.yssi.com](http://www.yssi.com)

©2012 YSI

EcoSense is a registered  
trademark of YSI Incorporated.

YSI

1725 Brannum Lane

Yellow Springs OH, 45387

800-897-4151 • 937-767-7241; Fax: 937-767-1058

Email: [environmental@ysi.com](mailto:environmental@ysi.com); Website: [www.yssi.com](http://www.yssi.com)



**STANDARD OPERATING PROCEDURE**  
**MAINE VOLUNTEER RIVER MONITORING PROGRAM**  
**METHODS FOR USING THE YSI 55**  
**HANDHELD METER IN RIVERS AND STREAMS**



**Note:** The mention of brand names does not constitute recommendation of a specific company.





## Volunteer River Monitoring Program (VRMP)

### Standard Operating Procedure Methods for using the YSI 55 Handheld Meter

**1. Applicability.** This standard operating procedure (SOP) is used by the Volunteer River Monitoring Program (VRMP) of the Maine Department of Environmental Protection's Division of Environmental Assessment. It applies to the collection of dissolved oxygen (DO) and temperature from rivers and streams in Maine using the YSI 55 handheld meter.

**2. Purpose.** This purpose of this SOP is to provide standardized methods for volunteer groups to determine dissolved oxygen and temperature of rivers and streams by volunteers as an instantaneous reading using the YSI 55 handheld meter.

#### **3. Definitions.**

**A. YSI.** Yellow Springs International, manufacturer of water quality monitoring meters.

**B. Probe.** Sensing device located at the end of a cable that is attached to the meter.

**C. KCl solution.** Potassium Chloride solution used to fill the probe.

**D. Calibration.** Set of procedures established by the manufacturer to ensure that the meter is operating properly; a critical quality assurance step in meter preparation prior to use.

**E. Membrane.** A clear, transparent and paper-thin substance similar to cellophane on the end of the probe. The membrane is permeable and allows gases such as oxygen to pass through into probe sensors while at the same time isolating most other undesirable substances.

**F. Jigging.** To move the probe under water using steady movements. Unless the probe is being held in swiftly flowing water, the probe shall be moved ("jigged") at least 1 foot per second to overcome the inherent consumption of oxygen by the sensor.

#### **4. Responsibilities.**

##### **A. *Volunteer Monitors & Volunteer Groups***

- **Certification.** It is the responsibility of the individual obtaining this data to maintain current certification for the parameter(s) they collect if they wish their data to be entered into the VRMP database. Training will be provided to volunteers on an annual basis by VRMP/DEP staff, and certification will last for one year from the date of training.



- **Data Recording.** It is the responsibility of the individual obtaining this data to record the results and additional qualifying information on current field sheets obtained from their affiliated watershed association or through the VRMP program of the DEP.
- **Data Quality Checks and Data Submission.** The data manager for the volunteer group will collect and enter volunteer field sheet data onto the appropriate computer file, perform quality assurance checks (Refer to Section 5.10 of the Quality Assurance Program Plan), and submit data to the VRMP following protocols outlined in the volunteer group's latest sampling and analysis plan (SAP) that has been approved by the VRMP.

### ***B. Volunteer River Monitoring Program (VRMP) Staff***

- **Oversight of Volunteer Groups and Volunteers.** VRMP staff will oversee volunteer groups and volunteers through a variety of ways including maintaining an up-to-date VRMP quality assurance program plan (QAPP); reviewing sampling and analysis plans (SAPs) of the volunteer groups; providing annual training/certification sessions for volunteers; conducting quality assurance checks on data submitted by volunteer groups and laboratories; and uploading data into the DEP's EGAD database. These tasks are described in greater detail in the VRMP's latest QAPP.

## **5. Guidelines and procedures.**

### ***A. YSI 55 Meter Preparation.***

- **First time use.** Follow manufacturer's instructions for preparing meter for first time use. (Refer to Appendix A, Section 3 "Preparing the Meter" and Section 4 "Preparing the Probe").
- **Beginning of field season.** Before each field season, volunteer monitoring groups shall conduct a full inspection of the meter. If membrane has been stored dry, follow manufacturer's instructions for first time use (see above). A new membrane and batteries shall be installed prior to the start of field sampling and additionally, as needed (refer to Appendix A, Section 4.3, "Probe Preparation", pg.5 and Section 4.4, "Membrane Installation", pg 6). VRMP staff will check meter against "benchmark" DO meter accuracy at DEP lab. In addition, each meter "setup" should be equipped with the following items so that field repairs can be undertaken as necessary:
  - Extra KCL fluid and membranes for probe
  - Extra batteries
  - Field data sheet
  - Screwdriver for removing back of meter to replace batteries
  - Pencil with eraser



- **Prior to field sampling.** Before each field sample collection, the volunteer shall inspect the meter including an inspection of the condition of the probe membrane and batteries.
  - (1) Check the membrane for air bubbles and wrinkles. If bubbles or wrinkles are present, remove membrane, refill with KCL solution, and replace membrane (Refer to 4.4, “Membrane Installation”, pg. 6).
  - (2) Check to make sure drops of water are not clinging to the membrane. If drops are present, blow on membrane to gently remove droplets. Don't tap; these probes are very fragile. Replace probe into the calibration chamber on the side of the meter.
  - (3) Batteries should be checked for charge and/or expiration.
  - (4) Be familiar with the testing, inspection, maintenance, and calibration considerations described in sections 5.6 through 5.8 of the VRMP QAPP (MDEP, 2014).
  - (5) Power on the meter and allow sufficient warm-up time (20 min) prior to initial use for the day.
  
- **Dissolved Oxygen Calibration.** If collecting dissolved oxygen measurements, the YSI 55 meter shall be calibrated each time the unit is turned on. Meters shall be calibrated to a 100% water-saturated air environment (for instructions, refer to 5, “Calibration”, pgs. 8-9).
  
- **Dissolved Oxygen Check Against “Zero Dissolved Oxygen” Standard.** VRMP staff shall check DO meters using zero oxygen solution at the beginning of the field season. Volunteers shall check their DO meter using zero oxygen solution mid-season. The zero oxygen solution is provided from VRMP/DEP staff. Volunteers shall record the dissolved oxygen value they measure with their meter in the appropriate blank on the field data sheet. (See section 5-B of this SOP for instructions on how to make measurements with the YSI 55 meter.)

#### ***B. Dissolved Oxygen and Temperature Measurements.***

- **Sampling Period and Site Location.** Sampling period and site location information will be documented in the volunteer groups’ SAPs (that require approval by the VRMP) which are submitted by the volunteer groups prior to any sampling. (Detailed information regarding how volunteer groups are to obtain and document site location information can be found in VRMP SOP-02 [Documenting Site Location].)
  
- **Sample Timing.** Dissolved oxygen data collected between dawn and 8 am are important for assessment of attainment of DO criteria within Maine’s Water Quality Standards. But, except as naturally occurs, DO concentrations below the applicable DO criteria at any time of day signal non-attainment. If there are no DO concentrations below the criteria after 8 am, then data between dawn and 8 am must be collected to assess attainment of the criteria.



- **Familiarize Yourself With the Meter.** Familiarize yourself with the basic operation, keypad, and readouts of the meter (4.5, “Probe Operation and Precautions”, pg. 7).
- **General Sampling Protocol.**
  - Record site location on data sheet.
  - Remove probe from calibration chamber.
  - Submerge probe in the water at the site where you are monitoring, as described in your group’s approved SAP.
  - For either parameter (DO or temperature), allow the reading to stabilize (at least 15 seconds) before recording the value on the field sheet.
  - Follow the instructions below measuring specific parameters.
  - The meter should remain turned on between stations, unless time between samplings exceeds 30-60 minutes. If meter is turned off, the field probe should be stored inside the calibration chamber during transport, sufficient time (20 min) should be allowed for warm-up, and the meter should be re-calibrated.
- **Dissolved Oxygen Measurements.**
  - (1) Review and follow the instructions for making DO measurements [5.0, “Calibration”, pgs. 8-9 and 6.0, “Principles of Operation”, pg. 10]. Make sure units are taken in mg/L (or ppm).
  - (2) *Note of caution:* Unless the probe is equipped with a stirrer, jiggling of the probe is extremely important for obtaining accurate dissolved oxygen readings, unless you have placed the probe in a swiftly-moving section of stream or river. (The probe is dependent on the amount of oxygen that passes across the membrane, and the probe actually consumes oxygen as it is making measurements.) An up-and-down or back and forth motion (jiggling) creating movement of at least 1 foot per second is recommended.
- **Temperature Measurements.**
  - (1) Review and follow the instructions for making temperature measurements [5.0, “Calibration”, pgs. 8-9 and 6.0, “Principles of Operation”, pg. 10].
- **Quality Control.**
  - (1) At the beginning of each field season, all VRMP staff and VRMP volunteers who collect dissolved oxygen, temperature, specific conductance, and salinity data will have a training/refresher/certification session to (re)familiarize themselves with the contents of this SOP.
  - (2) For every volunteer, a field duplicate shall be obtained for all parameters for at least 10% of their own sampling efforts. A field duplicate will be collected for every 10 samples monitored.
  - (3) Refer to the VRMP quality assurance project plan (QAPP) for more QA/QC details.



## 6. Equipment Care.

### A. *Start of field season.*

1. Follow manufacturer's directions for preparation of a new probe or renewing probe in the spring (refer to 4.3, "Probe Preparation", pg. 5 and 4.4, "Membrane Installation", pg. 6). Be sure to replace membrane at the start of each sampling season.
2. Use new batteries at start of each sampling season. An extra set of appropriate size batteries should be included in the meter carrying case.
3. If needed, clean the probe (anode and cathode) according to manual directions.
4. Each D.O. meter should be equipped with extra items for making repairs in the field. See section 5-A of this SOP for a list of items.

### B. *Field Season*

1. Ideally the meter should be in water-resistant case with padding to protect it from damage.
2. Allow the case and contents to air-dry at end of each day. This may be accomplished by simply propping the lid open. When contents are very wet, remove the contents and spread out to facilitate drying.
3. Keep meter from freezing.
4. Refer to 4.5, "Probe Operation and Precautions", pg. 7 for manufacturer's recommendations for maintenance requirements.

### C. *End of field season*

1. Completely dry meter, case, and all items in the case before storing.
2. Remove batteries.
3. Remove membrane, rinse, and dry.
4. Rinse entire probe and calibration chamber with distilled water.
5. Put membrane back on to keep dust and dirt out for winter.
6. Keep meter dry and at room temperature to prevent corrosion of electronic parts.
7. Review Appendix A for more tips.
8. Record winterization date and equipment repairs in your volunteer group's Equipment Log.
9. Label the meter and case as 'WINTERIZED' in an obvious manner (so users will know the current status of the unit).



## 7. Specifications

Measurement	Range	Resolution	Accuracy
Temperature	-5 °C to 45 °C	0.1 °C	±0.3 °C
Dissolved Oxygen (%)	0 to 200%	0.1% or 1% user selectable	±2% air sat or ±2% of reading, whichever is greater
	200 to 500%		±6% of reading
Dissolved Oxygen (mg/L)	0 to 20 mg/L	0.01 mg/L or 0.1 mg/L, user selectable	±0.3 mg/L or ±2% or reading, whichever is greater
	20 to 50 mg/L		±6% of reading

## 8. Appendix

### A. YSI Meter owner's manual:

YSI Incorporated. 2007. YSI Model 55 Handheld Dissolved Oxygen and Temperature System Operations Manual. Yellow Springs, Ohio.

## 9. References

### A. DEP Standard Operating Procedures:

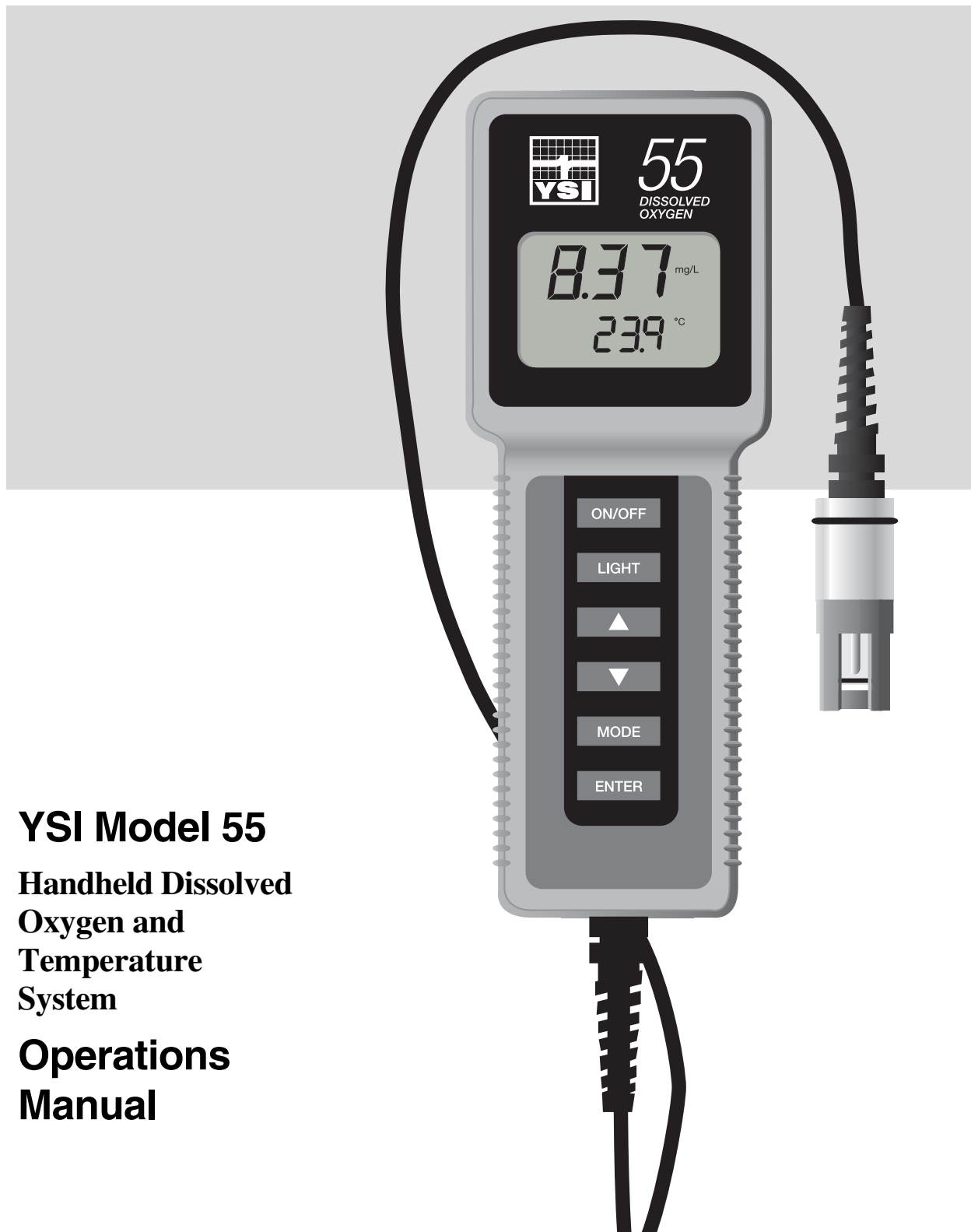
- Document number #:DEP-LW0890: Dissolved Oxygen and Temperature, Instantaneous Measurement using Electronic Meters
- Document number #: DEPLW0636: Protocols for using Hanna Dissolved Oxygen and Specific Conductance/Temperature/pH Meters

### B. Maine VRMP QAPP:

- Maine Department of Environmental Protection (MDEP). 2020. Maine Volunteer River Monitoring Program (VRMP) Quality Assurance Program Plan (VRMP). DEPLW-0984.



*YSI incorporated*



**YSI Model 55**  
**Handheld Dissolved**  
**Oxygen and**  
**Temperature**  
**System**  
**Operations**  
**Manual**





# Table of Contents

<b>1. General Description .....</b>	<b>1</b>
<b>2. Specifications .....</b>	<b>2</b>
<b>3. Preparing The Meter .....</b>	<b>3</b>
3.1. Unpacking .....	3
3.2. Warranty Card .....	3
3.3. Batteries .....	3
3.4. Calibration/Storage Chamber .....	4
3.5. Hand Strap .....	4
3.6. The Meter Case .....	4
<b>4. Preparing The Probe .....</b>	<b>5</b>
4.1. Description .....	5
4.2. Choosing The Right Membrane .....	5
4.3. Probe Preparation .....	5
4.4. Membrane Installation .....	6
4.5. Probe Operation and Precautions .....	7
<b>5. Calibration .....</b>	<b>8</b>
5.1. Before You Calibrate .....	8
5.2. The Calibration Process .....	8
<b>6. Principles Of Operation .....</b>	<b>10</b>
6.1. Discussion Of Measurement Errors .....	10
<b>7. Troubleshooting .....</b>	<b>12</b>
<b>8. Warranty And Repair .....</b>	<b>14</b>
8.1. Cleaning Instructions .....	15
8.2. Packing Instructions .....	16
<b>9. Required Notice .....</b>	<b>17</b>
<b>10. Accessories And Replacement Parts .....</b>	<b>18</b>
<b>11. Appendix A - Solubility Table .....</b>	<b>19</b>
<b>12. Appendix B - Conversion Chart .....</b>	<b>21</b>



# 1. General Description

---

The YSI Model 55 Handheld Dissolved Oxygen System is a rugged, micro-processor based, digital meter with an attached YSI dissolved oxygen probe.

The YSI Model 55 is designed for field use and is available with cable lengths of 12, 25 or 50 feet. The body of the probe has been manufactured with stainless steel to add rugged durability and sinking weight. The large Liquid Crystal Display (LCD) is easy to read and is equipped with a back-light for use in dark or poorly lighted areas.

The Model 55's micro-processor allows the system to be easily calibrated with the press of a few keys. Additionally, the micro-processor performs a self-diagnostic routine each time the instrument is turned on. The self-diagnostic routine provides you with useful information about the function of the instrument circuitry and the quality of the readings you obtain. For a list of these diagnostic features, see chapter 7 *Troubleshooting*.

The system simultaneously displays temperature in °C and dissolved oxygen in either mg/L (milligrams per liter) or % air saturation. The system requires only a single calibration regardless of which dissolved oxygen display you use. You can switch back and forth from % air saturation to mg/L with a single push of the **MODE** key.

A calibration chamber is built into the instrument. A small sponge in the chamber can be moistened to provide a water saturated air environment which is ideal for air calibration. This chamber is also designed for transporting and storing the probe. When the probe is stored in the chamber, the moist environment will prolong effective membrane performance and probe life.

The instrument is powered by six AA-size alkaline batteries. A new set of alkaline batteries will provide approximately 100 hours of continuous operation. When batteries need to be replaced, the LCD will display a "**LO BAT**" message.

The YSI Model 55 instrument case is splash resistant. You can operate your Model 55 in a steady rain without damage to the instrument.

## 2. Specifications

---

### Probe Operating Environment

Medium: fresh, sea, or polluted water

Temperature: -5 to +45°C

Depth: 0 to 12, 0 to 25 or 0 to 50 feet (depending on cable length)

**Meter Ambient Operating/Storage Temperature:** -10 to +50°C

**Material:** ABS, Stainless Steel, Acrylic, and other materials.

### Dimensions:

Height: 9.5 inches (24.13 cm)

Thickness: 2.2 inches (5.6 cm)

Width: 3.5 inches max. ( 8.89 cm)

Weight: 1.7 pounds ( 0.77 kg)

**Power:** 9 VDC - 6 AA-size Alkaline Batteries (included)

Approximately 100 hours operation from each new set of batteries

**Water Tightness:** Meets or exceeds IP65 standards

***Extensive testing of the YSI Model 55 suggests the following typical performance:***

### Temperature

Sensor Type.....Thermistor

Range.....-5 to +45°C

Accuracy .....± 0.2°C

Resolution .....0.1°C

### Dissolved Oxygen % Saturation

Sensor Type.....Membrane covered polarographic

Range.....0 to 200 % air saturation

Accuracy .....± 2 % air saturation

Resolution .....0.1 % air saturation

### Dissolved Oxygen mg/L

Sensor Type.....Calculated from % air saturation, temperature and salinity.

Range.....0 to 20 mg/L

Accuracy .....± 0.3 mg/L

Resolution .....0.01 mg/L

## 3. Preparing The Meter

---

### 3.1. Unpacking

When you unpack your new YSI Model 55 Handheld Dissolved Oxygen System for the first time, check the packing list to make sure you have received everything you should have. If there is anything missing or damaged, call the dealer from whom you purchased the Model 55. If you do not know which of our authorized dealers sold the system to you, call YSI Customer Service at 800-765-4974 or 937-767-7241, and we'll be happy to help you.

### 3.2. Warranty Card

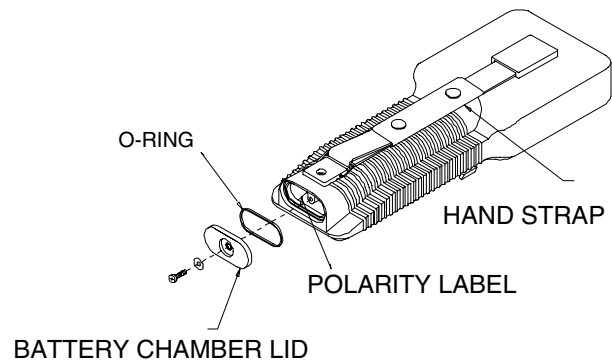
Before you do anything else, please complete the Warranty Card and return it to YSI. This will record your purchase of this quality instrument in our computer system. Once your purchase is recorded, you will receive prompt, efficient service in the event any part of your YSI Model 55 should ever need repair.

### 3.3. Batteries

There are a few things you must do to prepare your YSI Model 55 for use. First, locate the six AA-size alkaline batteries which were included. Use a screwdriver or a small coin to remove the thumbscrew on the bottom of the instrument. This thumbscrew holds the battery-chamber cover in place. The battery-chamber cover is marked with the words "OPEN" and "CLOSE."

NOTE: On some models, the battery cover thumbscrew may be unscrewed by hand (a screwdriver may not be required).

There is a small label inside each of the two battery-chamber sleeves. These labels illustrate the correct way to install the batteries into each sleeve of the battery-chamber.



**NOTE:** It is very important that the batteries be installed **ONLY** as illustrated. The instrument will not function if the batteries are installed incorrectly.

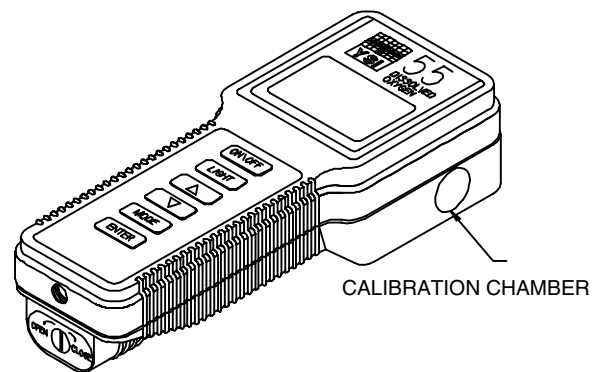
Turn the instrument on by pressing and releasing the **ON/OFF** button on the front of the instrument. The instrument will activate all segments of the display for a few seconds, which will be followed by a self test procedure which will last for several more seconds. During this power on self test sequence, the instrument's microprocessor is verifying that the instrument is working. If the instrument were to detect a problem, a **continuous** error message would be displayed. If the instrument does not operate, consult chapter 7 *Troubleshooting*.

**NOTE:** The information on the display will be meaningless since the probe has not yet been prepared.

You may also want to take the instrument into a dark room and, with the instrument ON, hold down the **LIGHT** key. The instrument back-light should illuminate the LCD so that the display can be easily read.

### **3.4. Calibration/Storage Chamber**

The Model 55 has a convenient calibration/storage chamber built into the instrument's side. This chamber provides an ideal storage area for the probe during transport and extended non-use. If you look into the chamber, you should notice a small round sponge in the bottom. Carefully put 3 to 6 drops of clean water into the sponge. Turn the instrument over and allow any excess water to drain out of the chamber. The wet sponge creates a 100% water saturated air environment for the probe which is ideal for dissolved oxygen calibration.



### **3.5. Hand Strap**

The hand strap is designed to allow comfortable operation of the Model 55 with minimum effort. If the hand strap is adjusted correctly, it is unlikely that the instrument will be easily dropped or bumped from your hand.

To adjust the hand strap on the back of the meter, unsnap the leather cover and pull the two Velcro strips apart. Place your hand between the meter and the strap and adjust the strap length so that your hand is snugly held in place. Press the two Velcro strips back together and snap the leather cover back into place.

### **3.6. The Meter Case**

The meter case is sealed at the factory and is not intended to be opened, except by authorized service technicians. **Do not attempt to separate the two halves of the meter case as this may damage the instrument, break the water-proof seal, and may void the manufacturer's warranty.**

## 4. Preparing The Probe

---

### 4.1. Description

The YSI Model 55 dissolved oxygen probe is a non-detachable, polarographic sensor designed specifically for the YSI Model 55 Handheld Dissolved Oxygen System. Probe cables are available in lengths of 12, 25 or 50 feet.

### 4.2. Choosing The Right Membrane

The YSI Model 5775 Standard Membrane Kit is supplied with the YSI Model 55. This kit contains thirty 1 mil (.001") membranes and a bottle of KCl solution. YSI recommends the 5775 membranes for most applications.

For special conditions, a 0.5 mil (.0005") membrane is available. Order YSI Model 5776 High Sensitivity Membrane Kit. This half-thickness membrane improves measurement time at low temperatures and helps suppress background current at very low dissolved oxygen levels. When data is routinely collected at sample temperatures below 15°C and at dissolved oxygen levels below 20% air saturation, the low signal current resulting from the use of the standard membranes tends to magnify the probe's inherent constant background signal. Using the high sensitivity membranes in this situation will decrease the percentage of error due to the probe's background current.

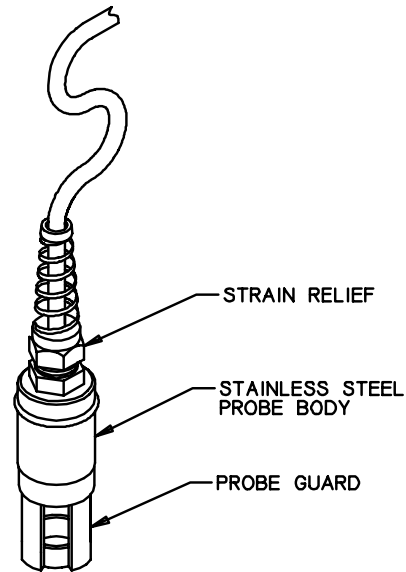
For long-term monitoring situations **ONLY**, a half-sensitivity, double-thickness, 2 mil (.002") membrane is available. For these applications, order the YSI Model 5685 Membrane Kit, which includes membranes and electrolyte.

### 4.3. Probe Preparation

The YSI Model 55 probe is shipped dry. **Before using the Model 55, the protective membrane on the probe tip must be removed, the probe must be filled with KCl solution and a new membrane must be installed.** Follow the instructions below to install the KCl solution and membrane.

To prepare for installation of a new membrane on your YSI Model 55 dissolved oxygen probe:

1. Unscrew the probe sensor guard.
2. Remove the old O-ring and membrane.
3. Thoroughly rinse the sensor tip and KCl reservoir with distilled water.
4. Prepare the electrolyte according to the directions on the KCl solution bottle.

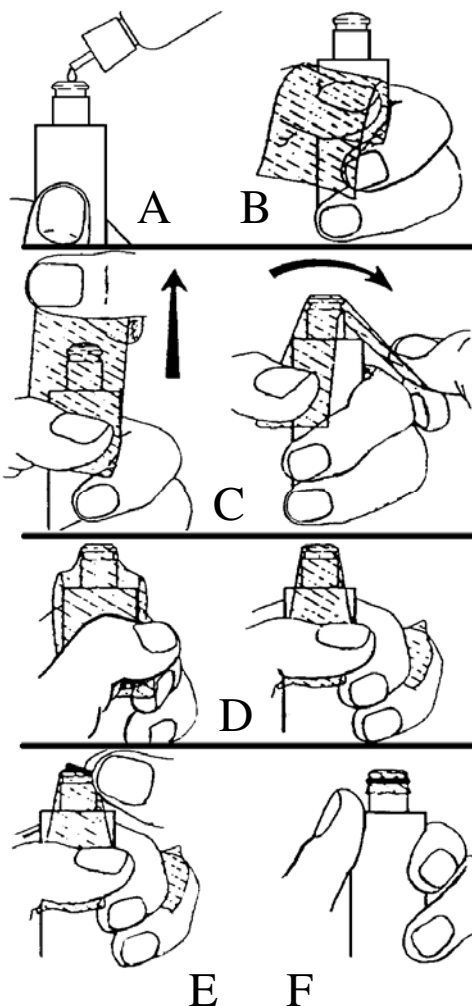


#### 4.4. Membrane Installation

- A. Secure a membrane between your thumb and the probe body. Add electrolyte to the probe until a large meniscus completely covers the gold cathode.

**NOTE:** Handle the membrane material with care, touching it at the ends only.

- B. With the thumb and forefinger of your other hand, grasp the free end of the membrane.
- C. With a continuous motion, stretch the membrane up, over, and down the other side of the sensor. Stretching forms the membrane to the contour of the sensor tip.
- D. Secure the end of the membrane under your forefinger while continuing to hold the probe.
- E. Roll the O-ring over the end of the probe, being careful not to touch the membrane surface. There should be no wrinkles in the membrane or trapped air bubbles under the membrane. Some wrinkles may be removed by lightly tugging on the edges of the membrane beyond the O-ring.
- F. Trim off excess membrane with scissors or a sharp knife. Check that the stainless steel temperature sensor is not covered by excess membrane.
- G. Shake off excess KCl. Rinse the stainless steel thoroughly with distilled water to prevent corrosion. Reinstall the sensor guard. The sensor should be kept in a humid environment (such as the calibration chamber) between measurements and when not in use.





#### **4.5. Probe Operation and Precautions**

1. Membrane life depends on usage. Membranes will last a long time if installed properly and treated with care. Erratic readings are a result of loose, wrinkled, damaged, or fouled membranes, or from large (more than 1/8" diameter) bubbles in the electrolyte reservoir. If erratic readings or evidence of membrane damage occurs, you should replace the membrane and the KCl solution. The average replacement interval is two to four weeks.
2. If the membrane is coated with oxygen consuming (e.g. bacteria) or oxygen evolving organisms (e.g. algae), erroneous readings may occur.
3. Chlorine, sulfur dioxide, nitric oxide, and nitrous oxide can affect readings by behaving like oxygen at the probe. If you suspect erroneous readings, it may be necessary to determine if these gases are the cause.
4. Avoid any environment which contains substances that may attack the probe materials. Some of these substances are concentrated acids, caustics, and strong solvents. The probe materials that come in contact with the sample include FEP Teflon, acrylic plastic, EPR rubber, stainless steel, epoxy, polyetherimide and the polyurethane cable covering.
5. For correct probe operation, the gold cathode must always be bright. If it is tarnished (which can result from contact with certain gases), or plated with silver (which can result from extended use with a loose or wrinkled membrane), the gold surface must be restored. To restore the cathode, you may either return the instrument to the factory or clean it using the YSI Model 5680 Probe Reconditioning Kit. Never use chemicals or abrasives not supplied with this kit.
6. It is also possible for the silver anode to become contaminated, which will prevent successful calibration. To clean the anode, remove the O-ring and membrane and soak the probe overnight in 3% ammonium hydroxide. Next, rinse the sensor tip and KCl reservoir with deionized water, add new KCl solution, and install a new membrane and O-ring. Turn the instrument on and allow the system to stabilize for at least 30 minutes. If, after several hours, you are still unable to calibrate, return the YSI Model 55 system to an authorized service center for service.
7. If the sensor O-ring is worn or loose, replace it with the appropriate O-ring provided in the YSI Model 5945 O-ring Pack.
8. To keep the electrolyte from drying out, store the probe in the calibration/storage chamber with the wet sponge.

## 5. Calibration

---

Dissolved oxygen calibration must be done in an environment with a known oxygen content. Since the amount of oxygen in the atmosphere is known, it makes an excellent environment for calibration (at 100% relative humidity). The calibration/storage chamber contains a moist sponge to create a 100% water saturated air environment.

### 5.1. Before You Calibrate

**Before you calibrate the YSI Model 55, complete the procedures discussed in the *Preparing the Meter* and *Preparing the Probe* chapters of this manual.**

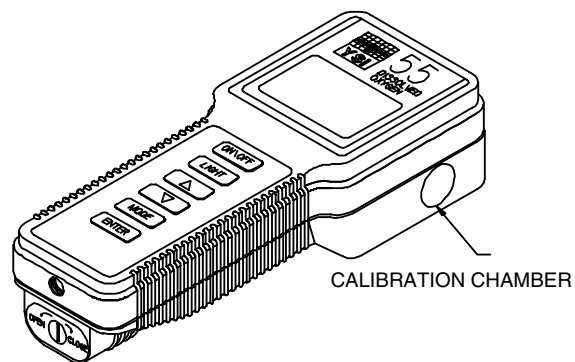
To accurately calibrate the YSI Model 55, you will need to know the following information:

- The approximate altitude of the region in which you are located.
- The approximate salinity of the water you will be analyzing. Fresh water has a salinity of approximately zero. Sea water has a salinity of approximately 35 parts per thousand (ppt). If you are not certain what the salinity of the sample water is, use a YSI Model 30 Salinity-Conductivity-Temperature meter to determine it.

### 5.2. The Calibration Process

1. Ensure that the sponge inside the instrument's calibration chamber is wet. Insert the probe into the calibration chamber.
2. Turn the instrument on by pressing the **ON/OFF** button on the front of the instrument. Wait for the dissolved oxygen and temperature readings to stabilize (usually 15 minutes is required after turning the instrument on).
3. To enter the calibration menu, use two fingers to press and release both the **UP ARROW** and **DOWN ARROW** keys at the same time.
4. The LCD will prompt you to enter the local altitude in hundreds of feet. Use the arrow keys to increase or decrease the altitude.

**EXAMPLE:** Entering the number 12 here indicates 1200 feet.



5. When the proper altitude appears on the LCD, press the **ENTER** key. The Model 55 should now display **CAL** in the lower left of the display, the calibration value should be displayed in the lower right of the display and the current DO reading (before calibration) should be on the main display.
6. Make sure that the DO reading (large display) is stable, then press the **ENTER** button. The LCD will prompt you to enter the approximate salinity of the water you are about to analyze. You can enter any number from 0 to 40 parts per thousand (PPT) of salinity. Use the arrow keys to increase or decrease the salinity setting. When the correct salinity appears on the LCD (zero for fresh water), press the **ENTER** key. The instrument will return to normal operation.

Once the calibration process is complete, the only keys which will remain operational are the **MODE** key, the **LIGHT** key and the **ON/OFF** key. You can move back and forth from reading dissolved oxygen in the mg/L mode or the % air saturation mode by pressing the **MODE** key. If you are working in a dark area and have difficulty reading the LCD, press and hold the **LIGHT** key to activate the back-light of the YSI Model 55. The **ON/OFF** key turns the instrument on or off.

**For best results:**

- Each time the Model 55 is turned off, re-calibrate before taking measurements.
- Calibrate at a temperature within  $\pm 10^{\circ}\text{C}$  of the sample temperature.

## 6. Principles Of Operation

---

The sensor consists of an acrylic body with a circular gold cathode embedded in the end. Inside the gold ring there is a small chamber containing a porous silver anode. In operation, this chamber is filled with a solution of KCl electrolyte containing a small amount of surfactant to improve wetting action.

A thin permeable membrane, stretched over the sensor, isolates the electrodes from the environment, while allowing gases to enter. When a polarizing voltage is applied to the sensor electrodes, oxygen which has passed through the membrane reacts at the cathode causing a current to flow.

The membrane passes oxygen at a rate proportional to the pressure difference across it. Since oxygen is rapidly consumed at the cathode, it can be assumed that the oxygen pressure inside the membrane is zero. Hence, the force causing the oxygen to diffuse through the membrane is proportional to the partial pressure of oxygen outside the membrane. As the oxygen partial pressure varies, so does the oxygen diffusion through the membrane. This causes the probe current to change proportionally.

It is important to recognize that oxygen dissolved in the sample is consumed during the test. It is therefore essential that the sample be continuously stirred at the sensor tip. If stagnation occurs, your readings will be artificially low. Stirring may be accomplished by mechanically moving the sample around the probe tip, or by rapidly moving the probe through the sample. The rate of stirring should be at least 1 foot per second.

### 6.1. Discussion Of Measurement Errors

There are three basic types of dissolved oxygen errors. Type 1 errors are related to limitations of instrument design and tolerances of instrument components. These are primarily the meter linearity and the resistor tolerances. Type 2 errors are due to basic probe accuracy tolerances, mainly background signal, probe linearity, and variations in membrane temperature coefficient. Type 3 errors are related to the operator's ability to determine the conditions at the time of calibration. If calibration is performed against more accurately known conditions, type 3 errors are appropriately reduced.

#### Type 1 Errors

- A. Meter linearity error:  $\pm 1\%$  of full scale reading, or  $\pm 0.15$  mg/L
- B. Component and circuitry error:  $\pm 0.05$  mg/L

#### Type 2 Errors

- A. DO errors caused by temperature compensation for measurements at  $\pm 10^\circ\text{C}$  from calibration temperature:  $\pm 1\%$  (0.08 mg/L at  $25^\circ\text{C}$ )

DO errors caused by temperature measurement errors: A maximum  $\pm 0.2^\circ\text{C}$  temperature error is equal to  $\pm 0.5\%$  (0.04mg/L at  $25^\circ\text{C}$ ).

## Type 3 Errors

### A. Altitude:

Operator Error: A 1000 foot error in altitude (when calibrating) is equal to an error of approximately 3.6% at the 10 mg/L level.

Instrument Error: The maximum DO error caused by calibrating to altitude in increments of 100 feet:  $\pm 0.18\%$  ( $< 0.015$  mg/L at 25°C)

### B. Humidity:

Errors occur if calibration is performed at less than 100% humidity. The worst possible case would be calibration at 0% humidity. The error varies with the calibration temperature as follows:

Temperature	Calibration Error at 0% humidity
0°C	0.09 mg/L
10°C	0.14 mg/L
20°C	0.21 mg/L
30°C	0.33 mg/L
40°C	0.50 mg/L

## Approximating The Error

It is unlikely that the actual error in any measurement will be the maximum possible error. A better error approximation is obtained using a root mean squared (r.m.s.) calculation:

$$\text{r.m.s. error} = \pm [1a^2 + 1b^2 + 2a^2 + 2b^2 + 3a^2 + 3b^2]^{1/2} \text{ mg/L}$$

**NOTE: This sample calculation is for a near extreme set of conditions.**

## 7. Troubleshooting

**NOTE: An error displayed briefly during the first few seconds after turning the instrument on does NOT indicate a problem.**

SYMPTOM	POSSIBLE CAUSE	ACTION
1. Instrument will not turn on	A. Low battery voltage B. Batteries installed incorrectly C. Meter requires service	A. Replace batteries (Page 3) B. Check battery polarity. (Page 3) C. Return system for service (Page 14)
2. Instrument will not calibrate	A. Membrane is fouled or damaged B. Probe anode is fouled or dark C. Probe cathode is tarnished D. System requires service	A. Replace membrane and KCl (Page 6) B. Clean anode (Page 7) C. Clean cathode (Page 7) D. Return system for service (Page 14)
3. Instrument "locks up"	A. Instrument has received a shock B. Batteries are low or damaged C. System requires service	A. Remove battery lid, wait 15 seconds for reset, replace lid. (Page 3) B. Replace batteries (Page 3) C. Return system for service (Page 14)
4. Instrument readings are inaccurate	A. Cal altitude is incorrect B. Salinity setting is incorrect C. Probe not in 100% water saturated air during Cal procedure D. Membrane fouled or damaged E. Probe anode is fouled or dark F. Probe cathode is tarnished G. System requires service	A. Recalibrate w/correct value (Page 8) B. Recalibrate w/correct value (Page 8) C. Moisten sponge and place in Cal chamber w/ probe and Recal (Page 4, 8) D. Replace membrane (Page 6) E. Clean anode (Page 7) F. Clean cathode (Page 7) G. Return system for service (Page 14)
5. LCD displays "LO BAT" or Main display flashes "OFF"	A. Batteries are low or damaged	A. Replace batteries (Page 3)
6. Main display reads "undr"	A. Probe current too low to calibrate B. System requires service	A. Replace membrane and KCl (Page 6) B. Clean anode (Page 7) C. Clean cathode (Page 7) D. Return system for service (Page 14)
7. Main display reads "OVER"	A. Sample O <sub>2</sub> concentration is more than 20 mg/L B. Probe current too high to calibrate C. System requires service	A. Recalibrate using correct altitude and salinity compensation (Page 8). B. Replace membrane and KCl (Page 6) C. Clean cathode (Page 7) D. Clean anode (Page 7) E. Return system for service (Page 14)
8. Main display reads "Er 0"	A. Calibration current out of range B. Instrument's self-test detects improper probe voltage during calibration	A. Replace membrane and KCl (Page 6) B. Clean anode (Page 7) C. Clean cathode (Page 7) D. Return system for service (Page 14)

<b>SYMPTOM</b>	<b>POSSIBLE CAUSE</b>	<b>ACTION</b>
9. Main display reads "Er 1" or Main display reads "Err" (Secondary display reads "ra")	A. Instrument's self-test detects a variance in RAM B. System requires service	A. Remove battery lid, wait 15 seconds for reset, replace lid. (Page 3) B. Return system for service (Page 14)
10. Main display reads "Er 2" or Main display reads "Err" (Secondary display reads "ro")	A. Instrument's self-test detects a variance in ROM checksum B. System requires service	A. Remove battery lid, wait 15 seconds for reset, replace lid. (Page 3) B. Return system for service (Page 14)
11. Main display reads "Er 3" or Main display reads "FAIL" (secondary display reads "eep")	A. Instrument's self-test detects a system malfunction or component failure B. System requires service	A. Remove battery lid, wait 15 seconds for reset, replace lid. (Page 3) B. Return system for service (Page 14)
12. Main display reads "Er 4"	A. Sample O <sub>2</sub> concentration is more than 20 mg/L B. System requires service	A. Recalibrate using correct altitude and salinity compensation (Page 8). B. Replace membrane and KCl (Page 6) C. Clean anode (Page 7) D. Clean cathode (Page 7) E. Return system for service (Page 14)
13. Main display reads "Er 5"	A. Displayed O <sub>2</sub> concentration is below -0.5 mg/L. B. System requires service	A. Recalibrate using correct altitude and salinity compensation (Page 8). B. Return system for service (Page 14)
14. Main display reads "Er 6"	A. Sample O <sub>2</sub> concentration is over range (% mode) B. System requires service	A. Recalibrate using correct altitude and salinity compensation (Page 8). B. Replace membrane and KCl (Page 6) C. Clean anode (Page 7) D. Clean cathode (Page 7) E. Return system for service (Page 14)
15. Main display reads "Er 7"	A. Displayed O <sub>2</sub> concentration is below -3.0% B. System requires service	A. Recalibrate using correct altitude and salinity compensation (Page 8). B. Return system for service (Page 14)
16. Secondary display reads "Er 8" or Main Display reads "OVER" (Secondary display reads "ovr")	A. Sample temperature is more than +45.9°C B. System requires service	A. Reduce the sample temperature B. Return system for service (Page 14)
17. Secondary display reads "Er 9" or Main Display reads "OVER" (Secondary display reads "udr")	A. Sample temperature is less than -5°C B. System requires service	A. Increase sample temperature. B. Return system for service (Page 14)
18. Main display reads "Er A"	A. Short in probe/cable assembly B. System requires service	A. Replace probe/cable assembly B. Return system for service (Page 14)

## 8. Warranty And Repair

---

YSI Model 55 Dissolved Oxygen and Temperature Meters are warranted for two years from date of purchase by the end user against defects in materials and workmanship. YSI Model 55 probes and cables are warranted for one year from date of purchase by the end user against defects in material and workmanship. Within the warranty period, YSI will repair or replace, at its sole discretion, free of charge, any product that YSI determines to be covered by this warranty.

To exercise this warranty, write or call your local YSI representative, or contact YSI Customer Service in Yellow Springs, Ohio. Send the product and proof of purchase, transportation prepaid, to the Authorized Service Center selected by YSI. Repair or replacement will be made and the product returned, transportation prepaid. Repaired or replaced products are warranted for the balance of the original warranty period, or at least 90 days from date of repair or replacement.

### **Limitation of Warranty**

This Warranty does not apply to any YSI product damage or failure caused by (i) failure to install, operate or use the product in accordance with YSI's written instructions, (ii) abuse or misuse of the product, (iii) failure to maintain the product in accordance with YSI's written instructions or standard industry procedure, (iv) any improper repairs to the product, (v) use by you of defective or improper components or parts in servicing or repairing the product, or (vi) modification of the product in any way not expressly authorized by YSI.

THIS WARRANTY IS IN LIEU OF ALL OTHER WARRANTIES, EXPRESSED OR IMPLIED, INCLUDING ANY WARRANTY OF MERCHANTABILITY OR FITNESS FOR A PARTICULAR PURPOSE. YSI's LIABILITY UNDER THIS WARRANTY IS LIMITED TO REPAIR OR REPLACEMENT OF THE PRODUCT, AND THIS SHALL BE YOUR SOLE AND EXCLUSIVE REMEDY FOR ANY DEFECTIVE PRODUCT COVERED BY THIS WARRANTY. IN NO EVENT SHALL YSI BE LIABLE FOR ANY SPECIAL, INDIRECT, INCIDENTAL OR CONSEQUENTIAL DAMAGES RESULTING FROM ANY DEFECTIVE PRODUCT COVERED BY THIS WARRANTY.

### **YSI Authorized Service Centers**

**Please visit [www.ysi.com](http://www.ysi.com) or contact YSI Technical Support for the nearest authorized service center.**

YSI Incorporated • Technical Support • Phone: +1 937 767-7241 • 800 897-4151 • Fax: 937 767-1058 • Email: [environmental@ysi.com](mailto:environmental@ysi.com)



## **8.1. Cleaning Instructions**

**NOTE: Before they can be serviced, equipment exposed to biological, radioactive, or toxic materials must be cleaned and disinfected.** Biological contamination is presumed for any instrument, probe, or other device that has been used with body fluids or tissues, or with waste water. Radioactive contamination is presumed for any instrument, probe or other device that has been used near any radioactive source.

If an instrument, probe, or other part is returned or presented for service without a Cleaning Certificate, and if in our opinion it represents a potential biological or radioactive hazard, our service personnel reserve the right to withhold service until appropriate cleaning, decontamination, and certification has been completed. We will contact the sender for instructions as to the disposition of the equipment. Disposition costs will be the responsibility of the sender.

When service is required, either at the user's facility or at YSI, the following steps must be taken to insure the safety of our service personnel.

1. In a manner appropriate to each device, decontaminate all exposed surfaces, including any containers. 70% isopropyl alcohol or a solution of 1/4 cup bleach to 1 gallon tap water are suitable for most disinfecting. Instruments used with waste water may be disinfected with .5% Lysol if this is more convenient to the user.
2. The user shall take normal precautions to prevent radioactive contamination and must use appropriate decontamination procedures should exposure occur.
3. If exposure has occurred, the customer must certify that decontamination has been accomplished and that no radioactivity is detectable by survey equipment.
4. Any product being returned to the YSI Repair Center, should be packed securely to prevent damage.
5. Cleaning must be completed and certified on any product before returning it to YSI.

## 8.2. Packing Instructions

1. Clean and decontaminate items to insure the safety of the handler.
2. Complete and include the Cleaning Certificate.
3. Place the product in a plastic bag to keep out dirt and packing material.
4. Use a large carton, preferably the original, and surround the product completely with packing material.
5. Insure for the replacement value of the product.

<b>Cleaning Certificate</b>	
Organization _____	
Department _____	
Address _____	
City _____	State _____ Zip _____
Country _____	Phone _____
Model No. of Device _____	Lot Number _____
Contaminant (if known) _____	
Cleaning Agent(s) used _____	
Radioactive Decontamination Certified?	
(Answer only if there has been radioactive exposure)	
_____ Yes _____ No	
Cleaning Certified By _____	
	Name          Date

## 9. Required Notice

---

The Federal Communications Commission defines this product as a computing device and requires the following notice:

This equipment generates and uses radio frequency energy and if not installed and used properly, may cause interference to radio and television reception. There is no guarantee that interference will not occur in a particular installation. If this equipment does cause interference to radio or television reception, which can be determined by turning the equipment off and on, the user is encouraged to try to correct the interference by one or more of the following measures:

- re-orient the receiving antenna
- relocate the computer with respect to the receiver
- move the computer away from the receiver
- plug the computer into a different outlet so that the computer and receiver are on different branch circuits.

If necessary, the user should consult the dealer or an experienced radio/television technician for additional suggestions. The user may find the following booklet, prepared by the Federal Communications Commission, helpful: "How to Identify and Resolve Radio-TV Interference Problems." This booklet is available from the U.S. Government Printing Office, Washington, DC 20402, Stock No. 0004-000-00345-4.

## 10. Accessories And Replacement Parts

---

The following parts and accessories are available from YSI or any Franchise Dealer authorized by YSI.

<b>YSI Order Number</b>	<b>Description</b>
5775	Standard Membrane and KCl kit (1 mil)
5776	High Sensitivity Membrane and KCl kit (.5 mil)
5685	Half Sensitivity Membrane Kit (2 mil)
5680	Probe Reconditioning Kit (sanding tool and disks for cathode cleaning)
5945	O-ring Kit
5520	Carrying Case
055205	Replacement Probe and Cable Assembly (12 feet)
055206	Replacement Probe and Cable Assembly (25 feet)
055229	Replacement Probe and Cable Assembly (50 feet)
055201	Replacement Front Case Cover
055242	Replacement Rear Case Cover
055244	Replacement Battery Cover Kit
055204	Replacement Case Gasket and Screw
055219	Storage Chamber Sponge
115603	Main Board Assembly

## 11. Appendix A - Solubility Table

**Solubility of Oxygen in mg/L in Water Exposed to Water-Saturated Air at 760 mm Hg Pressure.**

**Salinity = Measure of quantity of dissolved salts in water.**

**Chlorinity = Measure of chloride content, by mass, of water.**

$$S(\text{‰}) = 1.80655 \times \text{Chlorinity} (\text{‰})$$

Temp °C	Chlorinity: 0 Salinity: 0	5.0 ppt 9.0 ppt	10.0 ppt 18.1 ppt	15.0 ppt 27.1 ppt	20.0 ppt 36.1 ppt	25.0 ppt 45.2 ppt
0.0	14.62	13.73	12.89	12.10	11.36	10.66
1.0	14.22	13.36	12.55	11.78	11.07	10.39
2.0	13.83	13.00	12.22	11.48	10.79	10.14
3.0	13.46	12.66	11.91	11.20	10.53	9.90
4.0	13.11	12.34	11.61	10.92	10.27	9.66
5.0	12.77	12.02	11.32	10.66	10.03	9.44
6.0	12.45	11.73	11.05	10.40	9.80	9.23
7.0	12.14	11.44	10.78	10.16	9.58	9.02
8.0	11.84	11.17	10.53	9.93	9.36	8.83
9.0	11.56	10.91	10.29	9.71	9.16	8.64
10.0	11.29	10.66	10.06	9.49	8.96	8.45
11.0	11.03	10.42	9.84	9.29	8.77	8.28
12.0	10.78	10.18	9.62	9.09	8.59	8.11
13.0	10.54	9.96	9.42	8.90	8.41	7.95
14.0	10.31	9.75	9.22	8.72	8.24	7.79
15.0	10.08	9.54	9.03	8.54	8.08	7.64
16.0	9.87	9.34	8.84	8.37	7.92	7.50
17.0	9.67	9.15	8.67	8.21	7.77	7.36
18.0	9.47	8.97	8.50	8.05	7.62	7.22
19.0	9.28	8.79	8.33	7.90	7.48	7.09

Temp °C	Chlorinity: 0 Salinity: 0	5.0 ppt 9.0 ppt	10.0 ppt 18.1 ppt	15.0 ppt 27.1 ppt	20.0 ppt 36.1 ppt	25.0 ppt 45.2 ppt
20.0	9.09	8.62	8.17	7.75	7.35	6.96
21.0	8.92	8.46	8.02	7.61	7.21	6.84
22.0	8.74	8.30	7.87	7.47	7.09	6.72
23.0	8.58	8.14	7.73	7.34	6.96	6.61
24.0	8.42	7.99	7.59	7.21	6.84	6.50
25.0	8.26	7.85	7.46	7.08	6.72	6.39
26.0	8.11	7.71	7.33	6.96	6.62	6.28
27.0	7.97	7.58	7.20	6.85	6.51	6.18
28.0	7.83	7.44	7.08	6.73	6.40	6.09
29.0	7.69	7.32	6.96	6.62	6.30	5.99
30.0	7.56	7.19	6.85	6.51	6.20	5.90
31.0	7.43	7.07	6.73	6.41	6.10	5.81
32.0	7.31	6.96	6.62	6.31	6.01	5.72
33.0	7.18	6.84	6.52	6.21	5.91	5.63
34.0	7.07	6.73	6.42	6.11	5.82	5.55
35.0	6.95	6.62	6.31	6.02	5.73	5.46
36.0	6.84	3.52	6.22	5.93	5.65	5.38
37.0	6.73	6.42	6.12	5.84	5.56	5.31
38.0	6.62	6.32	6.03	5.75	5.48	5.23
39.0	6.52	6.22	5.98	5.66	5.40	5.15
40.0	6.41	6.12	5.84	5.58	5.32	5.08
41.0	6.31	6.03	5.75	5.49	5.24	5.01
42.0	6.21	5.93	5.67	5.41	5.17	4.93
43.0	6.12	5.84	5.58	5.33	5.09	4.86
44.0	6.02	5.75	5.50	5.25	5.02	4.79
45.0	5.93	5.67	5.41	5.17	4.94	4.72

\* This table is provided for your information only. It is **NOT** required when calibrating the Model 55 in accordance with the instructions outlined in the chapter entitled *Calibration*.

## 12. Appendix B - Conversion Chart

---

To Convert From	To	Equation
Feet	Meters	Multiply by 0.3048
Meters	Feet	Multiply by 3.2808399
Degrees Celsius	Degrees Fahrenheit	$(^{\circ}\text{C} \times 9/5) + 32$
Degrees Fahrenheit	Degrees Celsius	$(^{\circ}\text{F} - 32) \times 5/9$
Milligrams per liter (mg/L)	Parts per million (ppm)	Multiply by 1

*YSI incorporated*



1725 Brannum Lane  
Yellow Springs, Ohio 45387 USA  
937 767-7241 • 800 765-4974 • Fax 937 767-9353  
environmental@ysi.com • www.YSI.com  
© 1997 YSI Incorporated

055207  
A55207D - Web  
January 07





## STANDARD OPERATING PROCEDURE MAINE VOLUNTEER RIVER MONITORING PROGRAM



### METHODS FOR USING THE YSI Pro20 HANDHELD METER IN RIVERS AND STREAMS



**Note:** The mention of brand names does not constitute recommendation of a specific company.



## Volunteer River Monitoring Program (VRMP)

### Standard Operating Procedure Methods for using the YSI Pro20 Handheld Meter

**1. Applicability.** This standard operating procedure (SOP) is used by the Volunteer River Monitoring Program (VRMP) of the Maine Department of Environmental Protection's Division of Environmental Assessment. It applies to the collection of dissolved oxygen (DO) and temperature from rivers and streams in Maine using the YSI Pro20 handheld meter.

**2. Purpose.** This purpose of this SOP is to provide standardized methods for volunteer groups to determine dissolved oxygen and temperature of rivers and streams by volunteers as an instantaneous reading using the YSI Pro20 handheld meter.

#### 3. Definitions.

**A. YSI.** Yellow Springs International, manufacturer of water quality monitoring meters.

**B. Probe.** Electrode sensing portion of the cable assembly.

**C. O<sub>2</sub> solution.** Electrolyte solution used to fill the probe.

**D. Calibration.** Set of procedures established by the manufacturer to ensure that the meter is operating properly; a critical quality assurance step in meter preparation prior to use.

**E. Membrane.** A clear, transparent and paper-thin substance similar to cellophane on the end of the probe. The membrane is permeable and allows gases such as oxygen to pass through into probe sensors while at the same time isolating most other undesirable substances.

**F. Jigging.** To move the probe under water using steady movements. Unless the probe is being held in swiftly flowing water, the probe shall be moved ("jigged") at least ½ foot per second to overcome the inherent consumption of oxygen by the sensor.

#### 4. Responsibilities.

##### A. *Volunteer Monitors & Volunteer Groups*

- **Certification.** It is the responsibility of the individual obtaining this data to maintain current certification for the parameter(s) they collect if they wish their data to be entered into the VRMP database. Training will be provided to volunteers on an annual basis by VRMP/DEP staff, and certification will last for one year from the date of training.



- **Data Recording.** It is the responsibility of the individual obtaining this data to record the results and additional qualifying information on current field sheets obtained from their affiliated watershed association or through the VRMP program of the DEP.
- **Data Quality Checks and Data Submission.** The data manager for the volunteer group will collect and enter volunteer field sheet data onto the appropriate computer file, perform quality assurance checks (Refer to Section 5.10 of the Quality Assurance Program Plan), and submit data to the VRMP following protocols outlined in the volunteer group's latest sampling and analysis plan (SAP) that has been approved by the VRMP.

### ***B. Volunteer River Monitoring Program (VRMP) Staff***

- **Oversight of Volunteer Groups and Volunteers.** VRMP staff will oversee volunteer groups and volunteers through a variety of ways including maintaining an up-to-date VRMP quality assurance program plan (QAPP); reviewing sampling and analysis plans (SAPs) of the volunteer groups; providing annual training/certification sessions for volunteers; conducting quality assurance checks on data submitted by volunteer groups and laboratories; and uploading data into the DEP's EGAD database. These tasks are described in greater detail in the VRMP's latest QAPP.

## **5. Guidelines and procedures.**

### ***A. YSI Pro20 Meter Preparation.***

- **Sensor options.** The Pro20 has two sensor options for dissolved oxygen – Polarographic or Galvanic sensor. Be sure of which type of sensor is installed and follow requirements for that type of sensor and setup.
- **First time use.** Follow manufacturer's instructions for preparing meter for first time use. (Refer to "Connecting the Sensor and Cable", pgs. 4-9; "Navigating in the System Setup Menu", pgs. 9-10; and "System Setup Menu", pgs. 10-17).
- **Beginning of field season.** Before each field season, volunteer monitoring groups shall conduct a full inspection of the meter. If membrane has been stored dry, follow manufacturer's instructions for first time use (see above). A new membrane and batteries shall be installed prior to the start of field sampling and additionally, as needed (refer to "Membrane Installation", pgs. 7 and "Sensor Maintenance", pgs. 28-32). VRMP staff will check meter against "benchmark" DO meter accuracy at DEP lab. In addition, each meter "setup" should be equipped with the following items so that field repairs can be undertaken as necessary:
  - Extra KCL fluid and membranes for probe
  - Extra batteries



- Field data sheet
- Screwdriver for removing back of meter to replace batteries
- Pencil with eraser
- **Prior to field sampling.** Before each field sample collection, the volunteer shall inspect the meter including an inspection of the condition of the probe membrane and batteries.
  - (1) Check the membrane for air bubbles and wrinkles. If bubbles or wrinkles are present, remove membrane, refill with KCL solution, and replace membrane (Refer to “Sensor Maintenance”, pgs. 28-32).
  - (2) Check to make sure drops of water are not clinging to the membrane. If drops are present, blow on membrane to gently remove droplets. Don't tap; these probes are very fragile. Replace probe into the calibration chamber on the side of the meter.
  - (3) Batteries should be checked for charge and/or expiration.
  - (4) Be familiar with the testing, inspection, maintenance, and calibration considerations described in sections 5.6 through 5.8 of the VRMP QAPP (MDEP, 2014).
  - (5) Power on the meter and allow sufficient warm-up time prior to initial use for the day. The Polarographic sensor requires 5-15 minutes to warm-up. The Galvanic sensor requires 5-10 minutes to warm up.
- **Dissolved Oxygen Calibration.** If collecting dissolved oxygen measurements, the YSI Pro20 meter shall be calibrated each time the unit is turned on. Meters shall be calibrated to a 100% water-saturated air environment (for instructions, refer to “Calibration”, pgs. 17-21).
- **Dissolved Oxygen Check Against “Zero Dissolved Oxygen” Standard.** VRMP staff shall check DO meters using zero oxygen solution at the beginning and end of the field season. Volunteers shall check their DO meter using zero oxygen solution mid-season. The zero oxygen solution is provided from VRMP/DEP staff. Volunteers shall record the dissolved oxygen value they measure with their meter in the appropriate blank on the field data sheet.

### ***B. Dissolved Oxygen and Temperature Measurements.***

- **Sampling Period and Site Location.** Sampling period and site location information will be documented in the volunteer groups’ SAPs (that require approval by the VRMP) which are submitted by the volunteer groups prior to any sampling. (Detailed information regarding how volunteer groups are to obtain and document site location information can be found in VRMP SOP-02 [Documenting Site Location].)
- **Sample Timing.** Dissolved oxygen data collected between dawn and 8 am are important for assessment of attainment of DO criteria within Maine’s Water Quality



Standards. But, except as naturally occurs, DO concentrations below the applicable DO criteria at any time of day signal non-attainment. If there are no DO concentrations below the criteria after 8 am, then data between dawn and 8 am must be collected to assess attainment of the criteria.

- **Familiarize Yourself with the Meter.** Familiarize yourself with the basic operation, keypad, and readouts of the meter (“Key Pad”, pg. 3; “Taking Measurements”, pg. 22).
- **General Sampling Protocol.**
  - Record site location on data sheet.
  - Remove probe from calibration chamber.
  - Submerge probe in the water at the site where you are monitoring, as described in your group’s approved SAP.
  - For either parameter (DO or temperature), allow the reading to stabilize (at least 15 seconds) before recording the value on the field sheet.
  - Follow the instructions below measuring specific parameters.
  - The meter should remain turned on between stations, unless time between samplings exceeds 30-60 minutes. If meter is turned off, the field probe should be stored inside the calibration chamber during transport, sufficient time (5-15 min) should be allowed for warm-up, and the meter should be re-calibrated.
- **Dissolved Oxygen Measurements.**
  - (1) Review and follow the instructions for making DO measurements [“Taking Measurements”, pg. 22]. Make sure units are taken in mg/L (or ppm) and % saturation.
  - (2) *Note of caution:* Unless the probe is equipped with a stirrer, jiggling of the probe is extremely important for obtaining accurate dissolved oxygen readings, unless you have placed the probe in a swiftly-moving section of stream or river. (The probe is dependent on the amount of oxygen that passes across the membrane, and the probe actually consumes oxygen as it is making measurements.) An up-and-down or back and forth motion (jiggling) creating movement of at least ½ foot per second is recommended.
- **Temperature Measurements.**
  - (1) Record temperature value displayed on the screen.
- **Quality Control.**
  - (1) At the beginning of each field season, all VRMP staff and VRMP volunteers who collect dissolved oxygen, temperature, specific conductance, and salinity data will have a training/refresher/certification session to (re)familiarize themselves with the contents of this SOP.



(2) For every volunteer, a field duplicate shall be obtained for all parameters for at least 10% of their own sampling efforts. A field duplicate will be collected for every 10 samples monitored.

(3) Refer to the VRMP quality assurance project plan (QAPP) for more QA/QC details.

(4) Review “Connecting the Sensor and Cable”, pgs. 4-9; “System Setup Menu”, pgs. 10-17 and “Care, Maintenance and Storage”, pgs. 26-32.

## **6. Equipment Care.**

### ***A. Start of field season.***

1. Follow manufacturer's directions for preparation of a new probe or renewing probe in the spring (refer to “Membrane Installation”, pg. 7 and “Sensor Maintenance”, pgs. 28-32). Be sure to replace membrane at the start of each sampling season.
2. Use new batteries at start of each sampling season. An extra set of appropriate size batteries should be included in the meter carrying case.
3. Each D.O. meter should be equipped with extra items for making repairs in the field. See section 5-A of this SOP for a list of items.

### ***B. Field Season***

1. Ideally the meter should be in water-resistant case with padding to protect it from damage.
2. Allow the case and contents to air-dry at end of each day. This may be accomplished by simply propping the lid open. When contents are very wet, remove the contents and spread out to facilitate drying.
3. Keep meter from freezing.
4. Refer to “Care, Maintenance and Storage”, pgs. 26-32 for manufacturer’s recommendations for maintenance requirements.

### ***C. End of field season***

1. Completely dry meter, case, and all items in the case before storing.
2. Remove batteries.
3. Remove membrane cap, rinse, and dry.
4. Rinse entire probe and calibration chamber with distilled water.
5. Put membrane cap back on to keep dust and dirt out for winter.
6. Keep meter dry and at room temperature to prevent corrosion of electronic parts.
7. Review Appendix A for more tips.
8. Record winterization date and equipment repairs in your volunteer group’s Equipment Log.
9. Label the meter and case as ‘WINTERIZED’ in an obvious manner (so users will know the current status of the unit).



## 7. Specifications

Measurement	Range	Resolution	Accuracy
Temperature	-5 °C to 55 °C	0.1 °C	±0.3 °C
Dissolved Oxygen (%)	0 to 200%	0.1% or 1% user selectable	±2% air sat or ±2% of reading, whichever is greater
	200 to 500%		±6% of reading
Dissolved Oxygen (mg/L)	0 to 20 mg/L	0.01 mg/L or 0.1 mg/L, user selectable	±0.3 mg/L or ±2% or reading, whichever is greater
	20 to 50 mg/L		±6% of reading

## 8. Appendix

### A. YSI Meter owner's manual:

YSI Incorporated. October 2008. YSI Pro20 User Manual. Yellow Springs, Ohio.

## 9. References

### A. DEP Standard Operating Procedures:

- Document number #:DEP-LW0890: Dissolved Oxygen and Temperature, Instantaneous Measurement using Electronic Meters
- Document number #: DEPLW0636: Protocols for using Hanna Dissolved Oxygen and Specific Conductance/Temperature/pH Meters

### B. Maine VRMP QAPP:

- Maine Department of Environmental Protection (MDEP). 2020. Maine Volunteer River Monitoring Program (VRMP) Quality Assurance Program Plan (VRMP). DEPLW-0984.



# PRO20



## USER MANUAL

English

Français

Español

Deutsch



Item # 605597  
Rev B

Drawing # A605597  
October 2008

©2008 YSI Incorporated.

The YSI logo is a registered trademark of YSI Incorporated.  
Teflon is a registered trademark of E. I. du Pont de Nemours and Company.

# CONTENTS

---

Warranty .....	1
Introduction.....	2
Getting Started .....	2
Initial Inspection .....	2
Battery Installation.....	2
Keypad.....	3
Connecting the Sensor and Cable .....	4
Membrane Installation .....	7
Backlight.....	7
Powering Off.....	7
Run Screen .....	7
Navigation .....	8
First Power On .....	9
System Setup Menu .....	10
DO Local%.....	10
Last Digit Suppression (LDS).....	11
One Touch Calibration (One Touch Cal) .....	11
Audio .....	11
Contrast.....	11
Sensor Type .....	12
Membrane Type.....	13
Auto Stable .....	14
DO Units .....	14
Temperature Units.....	15
Pressure Units .....	15
Language.....	15
Auto Shutoff.....	15
Resetting the System Setup Menu to Factory Default .....	16
Exiting the System Setup Menu .....	17

Calibration .....	17
Temperature.....	17
Barometer.....	17
Dissolved Oxygen.....	18
Salinity Compensation Calibration .....	21
Taking Measurements .....	22
Saving and Viewing data.....	22
Saving Data.....	22
Viewing and Erasing Saved Data – Data mode .....	23
Principles of Operation .....	25
Care, Maintenance, and Storage .....	26
General Maintenance.....	26
Sensor Maintenance.....	28
Sensor Storage .....	32
Troubleshooting.....	33
Specifications.....	35
Accessories/Part Numbers.....	36
Declaration of Conformity.....	37
Recycling.....	38
Contact Information.....	39
Ordering & Technical Support.....	39
Service Information .....	39

# WARRANTY

---

The YSI Pro20 Instrument is warranted for three (3) years from date of purchase by the end user against defects in materials and workmanship, exclusive of batteries and any damaged caused by defective batteries. Pro20 cables are warranted for two (2) years from date of purchase by the end user against defects in material and workmanship. Pro20 Polarographic sensors are warranted for one (1) year and Galvanic sensors are warranted for six (6) months from date of purchase by the end user against defects in material and workmanship. Pro20 instruments, cables & probes are warranted for 90 days from date of purchase by the end user against defects in material and workmanship when purchased by rental agencies for rental purposes. Within the warranty period, YSI will repair or replace, at its sole discretion, free of charge, any product that YSI determines to be covered by this warranty.

To exercise this warranty, call your local YSI representative, or contact YSI Customer Service in Yellow Springs, Ohio at +1 937 767-7241, 800-897-4151 or visit [www.ysi.com](http://www.ysi.com) (Support tab). Send the product and proof of purchase, transportation prepaid, to the Authorized Service Center selected by YSI. Repair or replacement will be made and the product returned, transportation prepaid. Repaired or replaced products are warranted for the balance of the original warranty period, or at least 90 days from date of repair or replacement.

## LIMITATION OF WARRANTY

This Warranty does not apply to any YSI product damage or failure caused by:

- 1) failure to install, operate or use the product in accordance with YSI's written instructions;
- 2) abuse or misuse of the product;
- 3) failure to maintain the product in accordance with YSI's written instructions or standard industry procedure;
- 4) any improper repairs to the product;
- 5) use by you of defective or improper components or parts in servicing or repairing the product;
- 6) modification of the product in any way not expressly authorized by YSI.

THIS WARRANTY IS IN LIEU OF ALL OTHER WARRANTIES, EXPRESSED OR IMPLIED, INCLUDING ANY WARRANTY OF MERCHANTABILITY OR FITNESS FOR A PARTICULAR PURPOSE. YSI's LIABILITY UNDER THIS WARRANTY IS LIMITED TO REPAIR OR REPLACEMENT OF THE PRODUCT, AND THIS SHALL BE YOUR SOLE AND EXCLUSIVE REMEDY FOR ANY DEFECTIVE PRODUCT COVERED BY THIS WARRANTY. IN NO EVENT SHALL YSI BE LIABLE FOR ANY SPECIAL, INDIRECT, INCIDENTAL OR CONSEQUENTIAL DAMAGES RESULTING FROM ANY DEFECTIVE PRODUCT COVERED BY THIS WARRANTY.

# INTRODUCTION

---

Thank you for purchasing the YSI Pro20, an instrument from the YSI *Professional Series* product family. The Pro20 features an impact resistant and waterproof (IP-67) case, backlit display, user-selectable sensor options, internal barometer, and a rugged, rubber over-mold case.

The Pro20 provides valuable instructions and prompts near the bottom of the display that will guide you through operation and use. However, reading the entire manual is recommended for a better understanding of the Pro20's features.



*The Pro20 can not communicate to a PC via a Pro Plus communications saddle. Connecting the Pro20 to a communication saddle may cause erratic instrument behavior.*

## GETTING STARTED

---


### INITIAL INSPECTION

---

Carefully unpack the instrument and accessories and inspect for damage. Compare received parts with materials listed on the packing list. If any parts or materials are missing or damaged, contact YSI Customer Service at 800-897-4151 (+1-937-767-7241) or the Authorized YSI distributor from whom the instrument was purchased.

### BATTERY INSTALLATION

---

This instrument requires 2 alkaline C-cell batteries. Under normal conditions, battery life is approximately 400 hours at room temperature without using the back light. A battery symbol  will blink in the lower, left corner of the display to indicate low batteries when approximately 1 hour of battery life remains.

To install or replace the batteries:

- 1) Turn the instrument off and flip over to view the battery cover on the back.
- 2) Unscrew the four captive battery cover screws.
- 3) Remove the battery cover, and remove the old batteries if necessary.
- 4) Install the new batteries, ensuring correct polarity alignment (Figure 1).

- 5) Place the battery cover on the back of the instrument and tighten the four screws. Do NOT over-tighten.



Figure 1, Pro20 with battery cover removed. Note battery symbols indicating polarities.



The waterproof instrument case is sealed at the factory and is not to be opened, except by authorized service technicians. Do not attempt to separate the two halves of the instrument case as this may damage the instrument, break the waterproof seal, and will void the warranty.

## KEYPAD

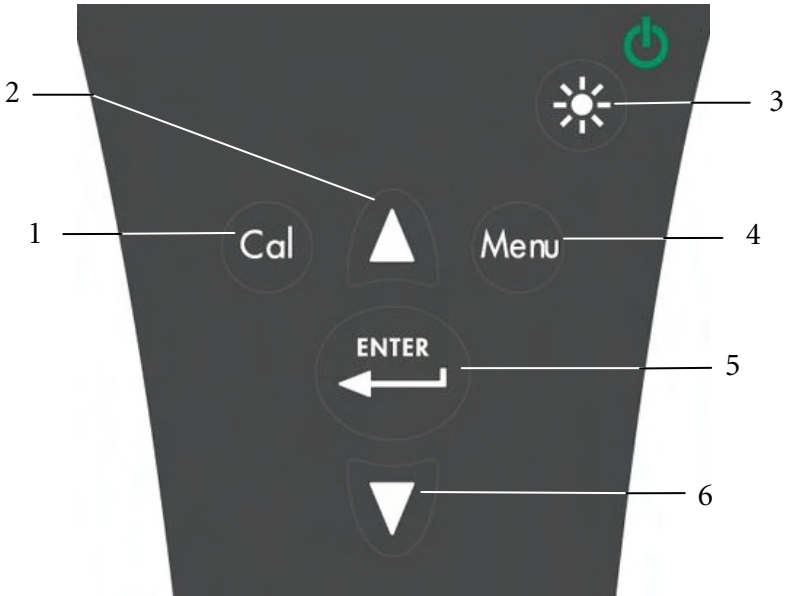








Figure 2, keypad

<i>Number</i>	<i>Key</i>	<i>Description</i>
1		<p><b>Calibrate</b></p> <p>Press and hold for 3 seconds to calibrate. Initiates One Touch Calibration. Opens Calibrate menu from the run screen if One Touch Calibration is disabled.</p>
2		<p><b>Up Arrow</b></p> <p>Use to navigate through menus, to navigate through box options at the bottom of the run screen, and to increase numeric inputs.</p>
3		<p><b>Power and Backlight</b></p> <p>Press once to turn instrument on. Press a second time to turn backlight on. Press a third time to turn backlight off. Press and hold for 3 seconds to turn instrument off.</p>
4		<p><b>Menu</b></p> <p>Use to enter the System Setup menu from the run screen.</p>
5		<p><b>Enter</b></p> <p>Press to confirm entries and selections.</p>
6		<p><b>Down Arrow</b></p> <p>Use to navigate through menus, to navigate through box options at the bottom of the run screen, and to decrease numeric inputs.</p>

## **CONNECTING THE SENSOR AND CABLE**

### **CONNECTING THE SENSOR**

“Sensor” refers to the removable portion or electrode sensing portion of the cable assembly, i.e. the dissolved oxygen sensor. “Bulkhead” refers to the portion of the cable with the single-pin connector (Figure 3).

The Pro20 has two compatible sensors for use with a field cable:

**Polarographic** – This sensor has a black sensor body and is engraved with the model number 2003. Polarographic will be abbreviated Polaro in the instrument.

**Galvanic** – This sensor has a grey sensor body and is engraved with the model number 2002.

For information about the differences on the two sensor types, see Sensor Type in the System Setup menu section and/or the Principles of Operation section of this manual.

If using a ProBOD sensor/cable assembly, there is no need to install a sensor because it has a built in Polarographic dissolved oxygen sensor.



*Before installing either sensor or connecting the cable to the instrument, the Sensor Type must be configured for the sensor being installed/connected. Failure to do this may result in damage not covered under warranty. The instrument will step you through this setup the first time it is powered on. See the System Setup menu section of this manual for instructions on configuring the Sensor Type after the first power on.*

- 1) Ensure both the sensor connector and sensor port on the cable are clean and dry.
- 2) Grasp the sensor with one hand and the cable bulkhead in the other.
- 3) Push the sensor into the connector on the cable until it is firmly seated and only 1 o-ring is visible. Failure to properly seat the sensor may result in damage.
- 4) Twist the sensor clockwise to engage threads and finger tighten. Do NOT use a tool. This connection is water-tight.

For more detailed instructions, please refer to the sensor installation sheet that is included with each sensor.

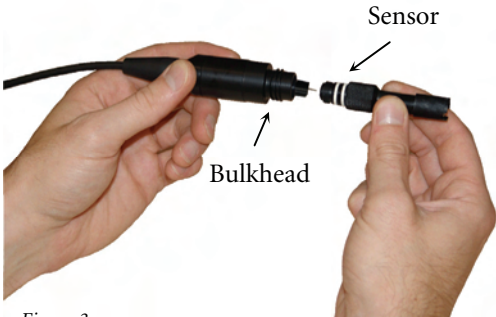


Figure 3



## CONNECTING THE CABLE

The Pro20 is designed for field and laboratory use. It is compatible with two different cable options:

- 1) The field rugged cable is available in standard lengths of 1, 4, 10, 20, 30, and 100 meters with special lengths available between 30 and 100 meters. This cable has a built in temperature sensor and includes a port for the dissolved oxygen sensor.
- 2) The ProBOD is a 1 meter probe/cable assembly with built in Polarographic dissolved oxygen and temperature sensors. It has an AC powered motor for sample stirring and is designed to fit into a 300 ml BOD bottle.

To connect the cable, align the keys in the cable connector to the slots in the instrument connector. Push together firmly and then twist the outer ring until it locks into place (Figure 4). This connection is water-proof.



Figure 4, Note the keyed connector.



*When disconnected, the sensor and cable's sensor connectors are NOT water-proof. Do not submerge the cable without a sensor installed. When disconnected, the cable's instrument connector and the connector on the instrument maintain a waterproof, IP-67 rating.*

## MEMBRANE INSTALLATION

---


The dissolved oxygen sensor is shipped with a dry, protective red cap that will need to be removed before using. It is very important to put a new membrane with electrolyte solution on the sensor after removing the red cap.

Prepare the membrane solution according to the instructions on the bottle. After mixing, allow the solution to sit for 1 hour. This will help prevent air bubbles from later developing under the membrane. Ensure you are using the correct electrolyte solution for the correct sensor. Galvanic sensors utilize electrolyte with a light blue label and Polarographic sensors utilize electrolyte with a white label. The Dissolved Oxygen sensor is supplied with cap membranes specific to the sensor type ordered (Polarographic or Galvanic). 5913 and 5914 membrane kits are for Galvanic sensors and the 5908 and 5909 membrane kits are for Polarographic sensors.

Remove and discard or save the red protective cap. Thoroughly rinse the sensor tip with distilled or deionized water. Fill the cap membrane 3/4 full of electrolyte solution, then tap the cap with a finger to release any trapped air. Be careful not to touch the membrane portion of the cap. Thread the membrane cap onto the sensor, moderately tight. Do not use a tool. It's typical for some of the electrolyte solution to spill over. It is best to allow the new cap to remain on a new sensor overnight before trying to calibrate. For detailed instructions on changing a membrane cap, see the Care, Maintenance, and Storage section of this manual.


## BACKLIGHT

---

Once the instrument is on, pressing power/backlight  key will turn on the display backlight. The backlight will remain on until the key is pressed again or after two minutes of not pressing any key on the keypad.


## POWERING OFF

---

To turn the instrument off, press and hold the power/backlight  key for three seconds.

## RUN SCREEN

---

Press the power/backlight  key to turn the instrument on. The instrument will run through a self test and briefly display a splash screen with system information before displaying the main run screen (Figure 5). The first time the Pro20 is

turned on, it will step through language, sensor, and membrane selections; see the First Power On section of this manual for more information.

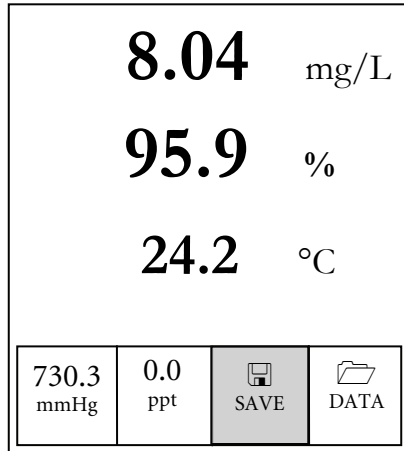







Figure 5, example of main run screen with Save highlighted.

## NAVIGATION



---

The up  and down  arrow keys allow you to navigate through the functions of the Pro20.

### NAVIGATING IN THE RUN SCREEN

When in the run screen, the up  and down  arrow keys will move the highlighted box along the bottom options. Once a box is highlighted, press enter  to access the highlighted option.

Description of run screen box functions from left to right:

<i>Option</i>	<i>Description</i>
Barometer reading	Highlight and press enter to calibrate the barometer
Salinity compensation value	Highlight and press enter to adjust salinity compensation value
 SAVE	Highlight and press enter to save current data to memory
 DATA	Highlight and press enter to view and/or erase saved data

## NAVIGATING IN THE SYSTEM SETUP MENU

When in the System Setup menu, the up and down arrow keys will move the highlighted bar up and down the system setup options. See the System Setup menu section of this manual for more information about these options.

### FIRST POWER ON

The instrument will step through an initial configuration when powered on for the first time. This will set the language, sensor, and membrane options. Use the up or down arrow keys to highlight the appropriate language, sensor, and membrane, then press enter to confirm (Figures 6, 7, and 8). The Sensor Type must be configured for the sensor installed. Failure to do this may result in damage not covered under warranty. If an incorrect option is selected, it may be changed in the System Setup menu.

Select Language:

English  
 Français  
 Español  
 Deutsch

Use ▲▼ to select Language  
 Press ↵ to confirm

Figure 6, Language selection

Select Sensor Type:

Polaro (black)  
 Galvanic (grey)

Use ▲▼ to select sensor type  
 Press ↵ to confirm

Figure 7, Sensor selection

Select Membrane Type:

1.25 (Yellow)  
 2.0 (Blue)


Use ▲▼ to select membrane  
 Press ↵ to confirm

Figure 8, Membrane selection

After selecting a language, sensor, and membrane, the run screen will appear. The next time the instrument is powered up the run screen will appear immediately after the self check. If the sensor type or membrane type is changed, ensure that it updated in the System Setup menu.

## SYSTEM SETUP MENU

---

Press the menu  key to access the following System Setup functions.

The System Setup menu contains multiple screens which are notated as 'pages'. The current page is indicated on the display, figure 9.

### DO LOCAL%

---

DO Local% can be enabled or disabled by using the up or down arrow keys to highlight it and then pressing enter. An 'X' in the box next to DO Local% indicates it is enabled (Figure 9).

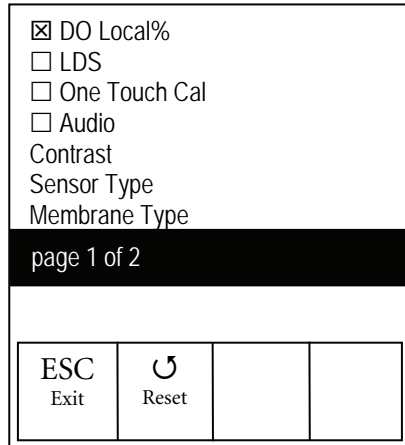



Figure 9, DO %Local is enabled.

When DO Local% is enabled, DO% values will be expressed as %L on the run screen.

DO Local% allows for localized dissolved oxygen measurements. This sets the DO% calibration value to 100% regardless of the altitude or barometric pressure. When DO Local% is enabled, the Pro20 will factor in the barometric pressure on each measurement. For example, if the barometric pressure changes, the DO %L reading would remain constant in air-saturated water or in water-saturated air. Local DO is ideal for EU compliance.

## LAST DIGIT SUPPRESSION (LDS)


---


Last Digit Suppression (LDS) can be enabled or disabled by using the up or down arrow keys to highlight it and pressing enter . An 'X' in the box next to LDS indicates it is enabled.

LDS rounds the DO value to the nearest tenth; i.e. 8.25 mg/L becomes 8.3 mg/L. LDS is automatically disabled during calibrations.

## ONE TOUCH CALIBRATION (ONE TOUCH CAL)


---

One Touch Calibration can be enabled or disabled by using the up or down arrow keys to highlight One Touch Cal and pressing enter . An 'X' in the box next to One Touch indicates it is enabled.

When One Touch Cal is enabled, press and hold the calibration  key for 3 seconds while in the run screen to calibrate Dissolved Oxygen to the barometer reading and salinity correction value. For more information on One Touch Calibration, see the Calibration section of this manual.

## AUDIO


---

Audio can be enabled or disabled by using the up or down arrow keys to highlight Audio and pressing enter . When enabled, there will be an 'X' in the box next to Audio.

When Audio is enabled, the Pro20 will beep twice to indicate stability when Auto Stable is enabled. The instrument will also beep when a key is pressed. When Audio is disabled, the Pro20 will not beep.

## CONTRAST

---

To adjust the display Contrast, use the up or down arrow keys to highlight Contrast, then press enter . Next, use the up or down arrow keys to adjust the contrast. The up arrow will darken the contrast and the down arrow will lighten the contrast. After adjusting the contrast, press enter to save and exit the Contrast adjustment option.

## EMERGENCY CONTRAST ADJUSTMENT


If necessary, there is an alternate method of adjusting the contrast. To adjust the contrast, press and hold the menu key, then press the up arrow key to darken the contrast or press the down arrow key to lighten the contrast.

## SENSOR TYPE



*The instrument's Sensor Type must be configured for the sensor installed. Failure to do this may result in damage not covered under warranty. If you observe readings very close to 0 or extremely high readings, i.e. 600%, your Sensor Type setting may be set incorrectly.*

**Sensor Type** sets the type of oxygen sensor being used; either Polarographic (black) or Galvanic (grey).

Use the up or down arrow keys to highlight **Sensor Type**, then press enter  to open a submenu. Highlight the sensor type corresponding to the sensor installed on the cable and press enter to confirm. The enabled sensor type will have an 'X' in the box next to it. Use the down arrow key to highlight the ESC – Exit, then press enter to save changes and to close the sensor submenu.

If using a ProBOD sensor/cable assembly, the sensor type should be set to polarographic.


The Pro20 has two compatible sensors for use with a field cable:

**Polarographic** – This sensor has a black sensor body and is engraved with the model number 2003. Polarographic will be abbreviated Polaro in the instrument.

**Galvanic** – This sensor has a grey sensor body and is engraved with the model number 2002.

In terms of physical configuration, membrane material, and general performance, YSI Professional Series Galvanic dissolved oxygen sensors are exactly like the Professional Series Polarographic sensors. The advantage of using Galvanic sensors is convenience. Galvanic sensors provide for an instant-on sensor without the need for warm-up time but this affects the life of the sensor. Polarographic sensors last longer and have a longer warranty but require a 5-15 minute warm-up time before use or calibration.

## MEMBRANE TYPE

**Membrane Type** sets the type of membrane used on the dissolved oxygen sensor; either 1.25 PE (Yellow) or 2.0 PE (blue). Use the up or down arrow keys to highlight **Membrane Type** and press enter  to open the membrane submenu. Highlight the membrane type corresponding to the membrane installed on the sensor and press enter to confirm. The enabled membrane type will have an 'X' in the box next to it. Use the down arrow key to highlight the ESC – Exit box and press enter to save changes and to close the membrane submenu.

The dissolved oxygen sensor is supplied with membranes specific to the sensor type ordered and are color coded as described in the following tables.

### Galvanic Membrane Kits

<i>Item</i>	<i>Color</i>	<i>Material</i>	<i>Description</i>
5913	Yellow	1.25 mil polyethylene	Faster response time and less flow dependence than traditional Teflon® membranes
5914	Blue	2.0 mil polyethylene	Less flow dependence than 1.25 mil but somewhat slower response

### Polarographic Membrane Kits

<i>Item</i>	<i>Color</i>	<i>Material</i>	<i>Description</i>
5908	Yellow	1.25 mil polyethylene	Faster response time and less flow dependence than traditional Teflon® membranes
5909	Blue	2.0 mil polyethylene	Less flow dependence than 1.25 mil but somewhat slower response

### Selecting a Dissolved Oxygen Membrane


<i>Membrane Type</i>	<i>Flow Dependence After 4 Minutes</i>	<i>Typical Response Time to 95%</i>
5913, 5908 - Yellow	25%	8 seconds
5914, 5909 – Blue	18%	17 seconds





## AUTO STABLE

---

**Auto Stable** utilizes preset values to indicate when a reading is stable. The preset values are adjustable in the System Setup menu. The user can input a % change in dissolved oxygen readings (0.0 to 1.9) over 'x' amount of time in seconds (3-19).


Highlight **Auto Stable** and press enter  to expand the submenu. Use the up or down arrow keys to highlight the DO% Change or seconds (secs) input field, then press enter to make the highlighted field adjustable. Use the up and down arrow keys to adjust the selected value, then press enter to confirm changes. Once you have confirmed any changes, highlight the ESC-Exit box and press enter to close the Auto Stable submenu.

To disable Auto Stable, set the DO% Change input to 0.0.

When Auto Stable is enabled, a  will display next to the dissolved oxygen value on the run screen and blink during stabilization. When the dissolved oxygen value has stabilized based on the Auto Stable settings, the  will display steadily and the instrument will beep twice if Audio is turned on.

## DO UNITS

---

Highlight **DO Units** and press enter  to open a submenu that will allow you to select the dissolved oxygen units displayed on the run screen. Highlight the desired unit(s) and press enter to enable or disable. An enabled dissolved oxygen unit will have an 'X' in the box next to it. Highlight the ESC-Exit box and press enter to save any changes and to close the DO units submenu.

There are three options for displaying dissolved oxygen:

- **mg/L** will show DO readings in milligrams per liter on a scale from 0 to 50 mg/L.
- **ppm** (parts per million) is equivalent to mg/L and will show the DO reading on a scale from 0 to 50 ppm.
- **%** will show DO readings in a percent scale from 0 to 500%. This value will be expressed %L when DO Local% is enabled.

Both % or %L and mg/L or ppm can be displayed simultaneously on the screen.

## TEMPERATURE UNITS

---

Highlight **Temperature Units** and press enter to open a submenu that will allow you to change the temperature units displayed in the run screen. Highlight the desired unit (Celsius or Fahrenheit) and press enter to enable. The enabled temperature unit will have an 'X' in the box next to it. Only one unit may be enabled at a time. Highlight the **ESC-Exit** box and press enter to save any changes and to close the Temperature Units submenu.

## PRESSURE UNITS

---

Highlight **Pressure Units** and press enter to open a submenu that will allow you to change the units displayed on the run screen. Highlight the desired unit (mmHg, inHg, mbar, psi, or kPa) and press enter to enable. The enabled pressure unit will have an 'X' in the box next to it. Only one unit may be enabled at a time. Highlight the **ESC-Exit** box and press enter to save any changes and to close the Pressure Units submenu.

## LANGUAGE

---

Highlight **Language** and press Enter to open a submenu that will allow you to change the language. Highlight the desired language (English, Spanish, German, or French) and press enter to enable. The enabled language will have an 'X' in the box next to it. Highlight **ESC-Exit** box and press enter to save any changes and to close the Language submenu.

The text in the boxes along the bottom of the run screen will always be displayed in English regardless of the language enabled in the System Setup menu.

## AUTO SHUTOFF

---

**Auto Shutoff** allows you to set the instrument to turn off automatically after a period of time. Use the up or down arrow keys to highlight **Auto Shutoff**, then press enter to open the submenu. Press enter while the minute field is highlighted to make it adjustable. Next, use the up and down arrow keys to adjust the shut off time from 0 to 60 minutes. Press enter to confirm and save the new shutoff time. Highlight **ESC-Exit** box, then press enter to close the Auto Shutoff submenu.

To disable Auto Shutoff, set the Time in Minutes to 0 (zero).

## RESETTING THE SYSTEM SETUP MENU TO FACTORY DEFAULT

---

To reset the Pro20 settings to factory default, press the down arrow key until the **Reset - ⏪** box is highlighted, then press enter. The instrument will ask you to confirm the reset. Highlight **Yes** and press enter to continue with the reset or highlight **No** and press enter to cancel the reset. A Factory Reset will not affect data saved in the unit's memory.


The following will be set in the Pro20 after performing a factory reset:

<i>Parameter</i>	<i>Reset Defaults</i>
Temperature Units	°C
Dissolved Oxygen Units	mg/L and %
Pressure Units	mmHg
Dissolved Oxygen Sensor Type	Last Setting Confirmed
Membrane Type	Last Setting Confirmed
Salinity Compensation Value	0.0 ppt
DO Local%	Off
One Touch Cal	On
Display Contrast	Set to mid range
Auto Shutoff	30 minutes
Auto Stable	Off (0.0 % Change and 10 secs)
LDS (Last Digit Suppression)	Off
Audio	On
Language	English
Dissolved Oxygen Calibration	Reset to factory default, 100% for enabled membrane and sensor*
Barometer Calibration	Reset to factory default*

\*It is recommended to perform a barometer and dissolved oxygen calibration after performing a reset.

# EXITING THE SYSTEM SETUP MENU

---

To exit the System Setup menu, press the down arrow key until the ESC - Exit box is highlighted, then press enter  to return to the run screen.

# CALIBRATION

---

## TEMPERATURE

---

All cable assemblies have built-in, temperature sensors. Temperature calibration is not required nor is it available.

## BAROMETER

---

The barometer in the Pro20 is calibrated at the factory. The barometer reading must be accurate to ensure accurate % calibrations and DO readings. If your barometer requires an adjustment, use the up or down arrow keys to highlight the barometer box on the run screen, then press enter. Next, use the up or down arrow keys to adjust the barometer reading to the **local, true barometric pressure**. Continually depress the up or down arrow keys to change the barometer value more rapidly. Press enter to confirm and save the barometer adjustment.



*Do not use a barometer value that is corrected to sea level. Laboratory barometer readings are usually “true” (uncorrected) values of air pressure and can be used “as is” for barometer calibration. Weather service readings are usually not “true”, i.e., they are corrected to sea level, and therefore cannot be used until they are “uncorrected”. An approximate formula for this “uncorrection” is:*

$$\text{True BP} = [\text{Corrected BP}] - [2.5 * (\text{Local Altitude in ft above sea level}/100)]$$



*Although the barometer range is 400.0 to 999.9 mmHg, you will be unable to adjust the value across the entire range. The barometer is very accurate and the instrument will not allow you to adjust the value drastically beyond what it is measuring during calibration.*

## DISSOLVED OXYGEN

---

The Pro20 can be easily calibrated with the press of one key by enabling One Touch Cal in the System Setup menu and following the One Touch Calibration procedure.

Ensure the barometer is reading accurately before performing a One Touch Calibration, DO %, or DO Local% calibration. These calibration procedures use the barometer reading during calibration. If the barometer reading is erroneous during a calibration, your dissolved oxygen values will be inaccurate.



*It is not necessary to calibrate in both % and mg/L or ppm. Calibrating in % will simultaneously calibrate mg/L and ppm and vice versa. YSI recommends calibrating dissolved oxygen in % for both ease and accuracy.*

### ONE TOUCH CALIBRATION

Perform this calibration procedure when One Touch Cal is enabled in the System Setup menu.


If using a field cable, install the sensor guard onto the probe. Moisten the sponge in the grey calibration/storage sleeve with a small amount of water and install it over the sensor guard. The sleeve should be moist, but should not have excess water that could cause water droplets to get on the membrane. The storage sleeve ensures venting to the atmosphere.

If using the ProBOD sensor/cable assembly, place the probe in 300 ml BOD bottle with a small amount of water (1/8 inch or 0.3 cm). The dissolved oxygen and temperature sensors should not be immersed in water.

If the calibration/storage sleeve is not available, substitute with a chamber of 100% relative humidity, vented to the atmosphere (not completely sealed).

Power the instrument on and wait approximately 5 to 15 minutes for the storage chamber to become completely saturated and to allow the sensor to stabilize if using a Polarographic sensor. If using a Galvanic sensor, wait approximately 5 to 10 minutes for the chamber to become completely saturated. Auto Shutoff time should be disabled or set to at least 20 minutes, see System Setup menu for more information on adjusting the Auto Shutoff.

Ensure the barometer reading is accurate. If necessary, perform a barometer calibration.

Press and hold the Calibrate  key for 3 seconds. The Pro20 will indicate **Calibrating %DO** on the display and automatically calibrate the sensor to the barometer and salinity correction values. This may take up to 2 minutes depending on the age of the sensor and membrane. You may press the Cal key at this time to cancel the calibration.

**Calibration Successful** will display for a few seconds to indicate a successful calibration and then the instrument will return to the run screen.

If the calibration is unsuccessful, an error message will display on the screen. Press the Cal key to exit the calibration error message and return to the run screen. See the Troubleshooting guide for possible solutions.


### **CALIBRATING IN PERCENT (DO %)**

Perform this calibration procedure when One Touch Cal is disabled in the System Setup menu.

Prepare a 100% humid environment for the sensor as described in the previous calibration section.

Power the instrument on and wait approximately 5 to 15 minutes for the storage chamber to become completely saturated and to allow the sensor to stabilize if using a Polarographic sensor. If using a Galvanic sensor, wait approximately 5 to 10 minutes for the chamber to become completely saturated. Auto Shutoff time should be disabled or set to at least 20 minutes, see System Setup menu for more information on adjusting the Auto Shutoff.

Ensure the barometer reading is accurate. If necessary, perform a barometer calibration.

Press and hold the Calibrate  key for 3 seconds. Highlight % and press enter. The Pro20 will display the current DO% and temperature readings along with the % calibration value. The % calibration value is based on the barometer reading.

Wait at least 3 seconds, then, once the DO% and temperature readings are stable, press enter to complete the calibration. Or, press the Cal key to cancel the calibration.

**Calibration Successful** will display for a few seconds to indicate a successful calibration and then the instrument will return to the run screen.

If the calibration is unsuccessful, an error message will display on the screen. Press the Cal key to exit the calibration error message and return to the run screen. See the Troubleshooting guide for possible solutions.


### **CALIBRATING IN PERCENT (DO LOCAL% ENABLED)**

Perform this calibration procedure when DO Local% is enabled in the System Setup menu.

Prepare a 100% humid environment for the sensor as described in the One Touch Calibration section.

Power the instrument on and wait approximately 5 to 15 minutes for the storage chamber to become completely saturated and to allow the sensor to stabilize if using a Polarographic sensor. If using a Galvanic sensor, wait approximately 5 to 10 minutes for the chamber to become completely saturated. Auto Shutoff time should be disabled or set to at least 20 minutes, see System Setup menu for more information on adjusting the Auto Shutoff.

Ensure the barometer reading is accurate. If necessary, perform a barometer calibration.

Press and hold the Calibrate  key for 3 seconds. %Local will be automatically highlight, press enter. The Pro20 will display the current DO% and temperature readings along with the % calibration value. The % calibration value will always be 100% for DO Local%.

Wait at least 3 seconds, then, once the DO% and temperature readings are stable, press enter to complete the calibration. Or, press the Cal key to cancel the calibration.

**Calibration Successful** will display for a few seconds to indicate a successful calibration and then the instrument will return to the run screen.

If the calibration is unsuccessful, an error message will display on the screen. Press the Cal key to exit the calibration error message and return to the run screen. See the Troubleshooting guide for possible solutions.

### **CALIBRATING IN MG/L**

Power the instrument on and place the sensor into a sample that has been titrated to determine the dissolved oxygen concentration. Continuously stir or move the probe through the sample at a rate of at least ½ foot per second (16 cm per second) during the entire calibration process. A stir plate may be helpful in this calibration.

Allow the dissolved oxygen and temperature readings to stabilize. This may take 5 to 15 minutes, depending on the age of the instrument, type of sensor, and condition of the sensor.

Press the Calibrate  key. Highlight **mg/L** and press enter.

Use the up and down arrow keys to adjust the mg/L reading to the value of the titrated sample. Press enter to confirm the value and calibrate or press the Cal key to cancel the calibration.

**Calibration Successful** will display for a few seconds to indicate a successful calibration and then the instrument will return to the run screen.

If the calibration is unsuccessful, an error message will display on the screen. Press the Cal key to exit the calibration error message and return to the run screen. See the Troubleshooting guide for possible solutions.

## **SALINITY COMPENSATION CALIBRATION**

---

The Pro20 uses a user inputted salinity value in ppt (parts per thousands) to compensate dissolved oxygen mg/L values. The salinity compensation value entered in the Pro20 should be the salinity value of the water you are testing.

To adjust the salinity compensation value, use the up or down arrow keys to highlight the salinity box on the run screen, and then press enter (Figure 10). Next, use the up or down arrow keys to adjust the salinity compensation value to the salinity of the water you are testing. You may enter a value between 0.0 and 70.0 parts per thousand (ppt). Press enter to confirm and to save the new salinity compensation value.

The salinity compensation value can be adjusted any time without the need to recalibrate dissolved oxygen.

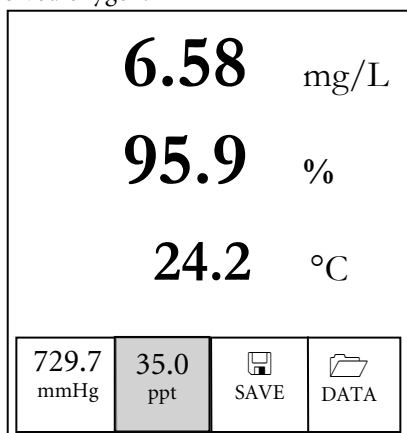


Figure 10, Salinity box highlighted.



# TAKING MEASUREMENTS

---

Before taking measurements, be sure the instrument has been calibrated to ensure the most accurate readings. Turn the instrument on and wait 5-15 minutes if using a polarographic sensor. If using a field cable/sensor, install the sensor guard to protect the sensor and membrane. Place the probe in the sample to be measured and give the probe a quick shake to release any air bubbles. Allow the temperature readings to stabilize. Next, stir the probe in the sample to overcome the stirring dependence of the dissolved oxygen sensor. You must provide at least 6 inches (16 cm) per second of water movement. Once the values plateau and stabilize you may record the measurement and/or store the data set. The dissolved oxygen reading will drop over time if stirring is ceased. If placing the DO sensor into a stream or fast flowing waters it is best to place it perpendicular to the flow and NOT facing into the flow.

If using the DO sensor in an aeration tank/basin it is helpful to make sure bubbles do not burst on the membrane. This may cause unstable readings to occur. You should be able to prevent this by pointing the sensor upwards so it's facing the sky and twist tying, zip tying, or rubber banding the bulkhead to the cable. Essentially making a simple curve to the cable without bending or breaking the cable will allow you to lower the sensor into the aeration tank while the sensor points skyward and the bubbles are no longer bursting on the membrane surface.

## SAVING AND VIEWING DATA

---

The Pro20 can store 50 data sets in non-volatile memory for later viewing. A data set includes the values currently on the display, i.e. temperature in Celsius or Fahrenheit and dissolved oxygen in % and/or mg/L or ppm. Each data point is referenced with a data set number, 01 through 50.



*The Pro20 can not communicate to a PC via a Pro Plus communications saddle. Connecting the Pro20 to a communication saddle may cause erratic instrument behavior.*

## SAVING DATA

---

From the run screen, use the up or down arrow keys to highlight the Save box and press enter to save the current readings. The instrument will indicate the data set is saved and display the saved data set's number (Figure 11).

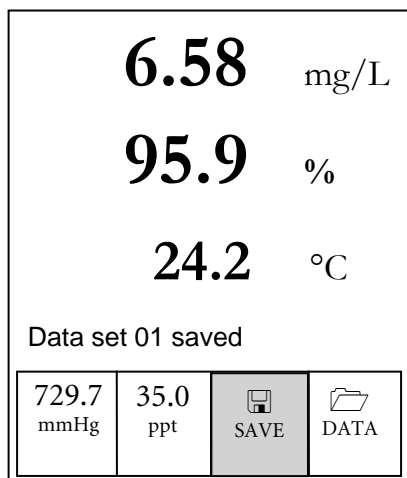


Figure 11, Data set saved

The instrument will display ‘Memory Full’ if all 50 data sets have been saved and you attempt to save another data set.

## **VIEWING AND ERASING SAVED DATA – DATA MODE**

---

Data mode allows you to view and erase saved data. From the run screen, use the up or down arrow keys to highlight Data and press enter to access data mode. Note that the function boxes at the bottom of the display are different in data mode (Figure 12).

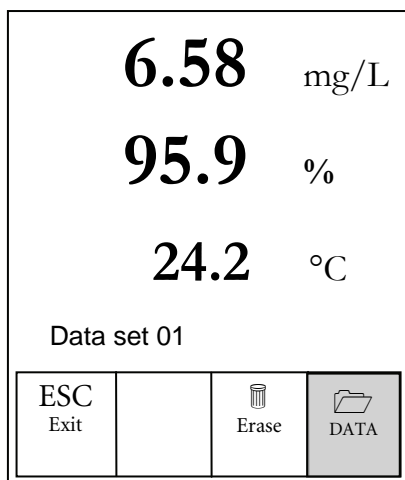


Figure 12, Data mode

## VIEWING DATA

Once in data mode, use the up and down arrow keys to view saved data sets in sequential order or press enter to access the bottom functions. After accessing the bottom functions, highlight the Data box and press enter to regain access to viewing data. The data set that is displayed will be indicated by the data set number, 01 through 50.

## ERASING DATA

While viewing saved data, press the enter key to access the function boxes at the bottom of the display. Next, use the up or down arrow keys to highlight Erase, then press enter. The instrument will give you the option to erase one or all data sets (Figure 13).

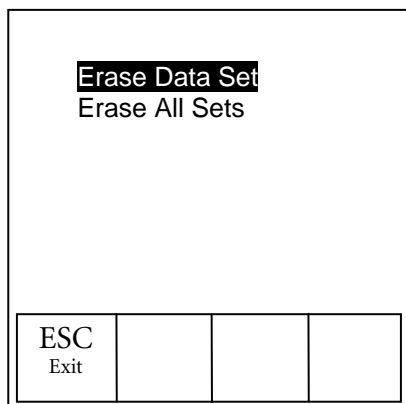


Figure 13, erasing data

Use the up or down arrow key to select Erase Data Set, Erase All Sets, or the ESC-Exit function box, then press enter to confirm.

Select ESC-Exit and press enter to exit erase mode without erasing any data.

Select Erase Data Set and press enter to erase the data set that was displayed before entering erase mode. For example, if data set 12 was displayed before entering erase mode, and Erase Data Set is selected, Data Set 12 will be erased from memory and the sets AFTER that number will move up to keep them sequential. So, if there were 15 records and number 12 is erased then 13 becomes 12, 14 becomes 13, and 15 becomes 14. The instrument will return to data mode after erasing one data set.

Select Erase All Data Sets and press enter to clear the Pro20 memory and return to data mode.

While in Data mode, press enter to access the bottom functions. Next, highlight the ESC-Exit box and press enter to return to the run screen.

## PRINCIPLES OF OPERATION

---

The polarographic sensor consists of a silver body as the anode and a circular gold cathode embedded in the end. The galvanic sensor consists of a zinc anode and silver cathode. The polarographic sensor requires an applied voltage for operation while the galvanic sensor electrode potentials are dissimilar enough to reduce oxygen with applied voltage.

Both sensors have a thin semi-permeable membrane, stretched over the sensor, which isolates the electrodes from the environment, while allowing gases to enter. In operation, this end of the sensor is filled with a solution of electrolyte containing a small amount of surfactant to improve wetting action.

When a polarizing voltage is applied to the polarographic sensor electrodes, oxygen that has passed through the membrane reacts at the cathode causing a current to flow. This same reaction takes place with the galvanic sensor without the applied voltage.

For both polarographic and galvanic DO sensors, oxygen diffuses through the membrane at a rate proportional to the oxygen pressure difference across it. Since oxygen is rapidly consumed at the cathode, it can be assumed that the oxygen pressure inside the membrane is zero. Hence, the amount of oxygen diffusing through the membrane is proportional to the absolute pressure of oxygen outside the membrane. If the oxygen pressure increases, more oxygen diffuses through the membrane and more current flows through the sensor. A lower pressure results in less current.

# CARE, MAINTENANCE, AND STORAGE

---

This section describes the proper procedures for care, maintenance and storage of the sensors. The goal is to maximize their lifetime and minimize down-time associated with improper sensor usage.

## **GENERAL MAINTENANCE**

---

### **GENERAL MAINTENANCE - O-RINGS**

The instrument utilizes o-rings as seals to prevent water from entering the battery compartment and the sensor ports. Following the recommended procedures will help keep your instrument functioning properly.

If the o-rings and sealing surfaces are not maintained properly, it is possible that water can enter the battery compartment and/or sensor ports of the instrument. If water enters these areas, it can severely damage the battery terminals or sensor ports causing loss of battery power, false readings and corrosion to the sensors or battery terminals. Therefore, when the battery compartment lid is removed, the o-ring that provides the seal should be carefully inspected for contamination (e.g. debris, grit, etc.) and cleaned if necessary.

The same inspection should be made of the o-rings associated with the dissolved oxygen sensor connector when it is removed. If no dirt or damage to the o-rings is evident, then they should be lightly greased without removal from their groove. However, if there is any indication of damage, the o-ring should be replaced with an identical o-ring. At the time of o-ring replacement, the entire o-ring assembly should be cleaned.

To remove the o-rings:

---

Use a small, flat-bladed screwdriver or similar blunt-tipped tool to remove the o-ring from its groove. Check the o-ring and the groove for any excess grease or contamination. If contamination is evident, clean the o-ring and nearby plastic parts with lens cleaning tissue or equivalent lint-free cloth. Alcohol can be used to clean the plastic parts, but use only water and mild detergent on the o-ring itself. Also, inspect the o-rings for nicks and imperfections.



*Using alcohol on o-rings may cause a loss of elasticity and may promote cracking.*

*Do not use a sharp object to remove the o-rings. Damage to the o-ring or the groove may result.*

Before re-installing the o-rings, make sure to use a clean workspace, clean hands, and avoid contact with anything that may leave fibers on the o-ring or grooves. Even a very small amount of contamination (hair, grit, etc.) may cause a leak.

To re-install the o-rings:

---

Place a small amount of o-ring grease between your thumb and index finger. (More grease is NOT BETTER!)

Draw the o-ring through the grease while pressing the fingers together to place a very light covering of grease to the o-ring. Place the o-ring into its groove making sure that it does not twist or roll.

Use the previously grease-coated finger to once again lightly go over the mating surface of the o-ring.



*Do not over-grease the o-rings. The excess grease may collect grit particles that can compromise the seal. Excess grease can also cause the waterproofing capabilities of the o-ring to diminish, potentially causing leaks. If excess grease is present, remove it using a lens cloth or lint-free cloth.*

## GENERAL MAINTENANCE – DO SENSOR PORT

It is important that the entire sensor connector end be dry when installing, removing, or replacing. This will prevent water from entering the port. Once a sensor is removed, examine the connector inside the port. If any moisture is present, use compressed air to completely dry the connector or place directly in front of a steady flow of fresh air. If the connector is corroded, contact YSI Technical Support or the Authorized dealer where you purchased the instrument.



*Remove sensors upside down (facing the ground) to help prevent water from entering the port upon removal.*

## SENSOR MAINTENANCE

### SENSOR MAINTENANCE - TEMPERATURE

You must keep the temperature portion of the sensor free of build up. Other than that, the sensor requires no maintenance. A toothbrush can be used to scrub the temperature sensor if needed.

### SENSOR MAINTENANCE – DISSOLVED OXYGEN

#### Membrane Cap Installation

The DO sensor (Polarographic and Galvanic) is shipped with a dry, protective red cap that will need to be removed before using. Remove the protective cap or used membrane cap and replace it with a new membrane cap following these instructions:

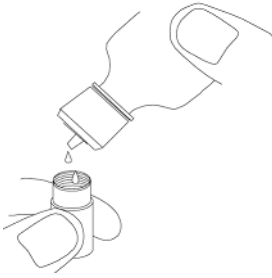
Remove the sensor guard to access the sensor tip.



Remove the protective red cap or unscrew and remove any old membrane cap by holding the sensor when unscrewing the membrane cap and discard.

Thoroughly rinse the sensor tip with distilled or DI water.

Fill a new membrane cap with O<sub>2</sub> sensor solution that has been prepared according to the directions on the bottle. Be very careful not to touch the membrane surface.



Lightly tap the side of the membrane cap to release bubbles that may be trapped.

Thread the membrane cap onto the sensor. It is normal for a small amount of electrolyte to overflow.



Replace the sensor guard.

## Polarographic Sensors – Model # 605203

---

The KCl (potassium chloride) solution and the membrane cap should be changed at least once every 30 days during regular use. In addition, the KCl solution and membrane should be changed if (a) bubbles are visible under the membrane; (b) significant deposits of dried electrolyte are visible on the membrane; and (c) if the sensor shows unstable readings or other sensor-related symptoms.

During membrane changes, examine the gold cathode at the tip of the sensor and the silver anode along the shaft of the sensor. If either the silver anode is black in color or the gold cathode is dull, the sensor *may* need resurfaced using the fine sanding disks included in the membrane kit. Do not sand the electrode every membrane change as this is not *routine* maintenance. In fact, visually, the anode may appear tarnished and operate just fine. YSI recommends using the 400 grit wet/dry sanding disks after a membrane change if the sensor has difficulty stabilizing or calibrating.

To clean and resurface the sensor, follow the instructions below.

### Gold Cathode

For correct sensor operation, the gold cathode must be textured properly. It can become tarnished or plated with silver after extended use. Never use chemicals or abrasives that have not been recommended or supplied by YSI.



First dry the sensor tip completely with lens cleaning tissue. Wet a sanding disc and place it face up in the palm of your hand. Next, with your free hand, hold the sensor in a vertical position, tip down. Place the sensor tip directly down on the sanding disc and twist it in a circular motion to sand the gold cathode. The goal is to sand off any build-up and to lightly scratch the cathode to provide a larger surface area for the O<sub>2</sub> solution under the membrane. Usually, 3 to 4 twists of the sanding disc are sufficient to remove deposits and for the gold to appear to have a matte finish. Rinse thoroughly and wipe the gold cathode with a wet paper towel before putting on a new membrane cap. If the cathode remains tarnished, contact YSI Technical Support or the Authorized dealer where you purchased the instrument.

### **Silver Anode**

After extended use, a thick layer of Silver Chloride (AgCl) builds up on the silver anode reducing the sensitivity of the sensor. The anode must be cleaned to remove this layer and restore proper performance. The cleaning can be chemical and/or mechanical:

**Chemical cleaning:** Remove the membrane cap and rinse the sensor with deionized or distilled water. Soak the sensing section of the sensor in a 14% ammonium hydroxide solution for 2 to 3 minutes or in a 3% ammonia solution overnight for 8-12 hours (most household ammonia cleaners are typically around 3%). Rinse heavily in cool tap water followed by a thorough rinsing with distilled or deionized water. The anode should then be thoroughly wiped with a wet paper towel to remove the residual layer from the anode. You can smell the tip of the sensor to help ensure all the ammonia has been rinsed off. Trapping residual ammonia under the new membrane cap can quickly tarnish the electrode and/or give false readings.



*Chemical cleaning should be performed as infrequently as possible. First attempt a membrane change and recalibrate. If a new membrane does not resolve the problem, then proceed with cleaning.*

**Mechanical cleaning:** In order to sand the silver anode along the shaft of the sensor, simply hold the sensor in a vertical position. Wet the sanding disc and gently wrap it around the sensor and twist it a few times to lightly sand the anode (the goal is to simply sand off any build-up without scratching or removing layers of the anode itself). Usually, 3 to 4 twists of the sanding disc are sufficient to remove deposits. However, in extreme cases, more sanding may be required to regenerate the original silver surface.

After completing the sanding procedure, repeatedly rinse the electrode with clean water and wipe with lens cleaning tissue to remove any grit left by the sanding disc. Thoroughly rinse the entire tip of the sensor with distilled or deionized water and install a new membrane.



***IMPORTANT:*** Be sure to: (1) Use only the fine sanding discs provided and (2) Sand as mentioned in the above procedures. Not adhering to either of these instructions can damage the electrodes.

If this procedure is unsuccessful, as indicated by improper sensor performance, contact YSI Technical Support or the Authorized dealer where you purchased the instrument.

#### Galvanic Sensors – Model # 605202

---

We recommend that the Sodium Chloride (NaCl) solution and the membrane cap be changed at least once every 60 days during regular use. In addition, the NaCl solution and membrane should be changed if (a) bubbles are visible under the membrane; (b) significant deposits of dried electrolyte are visible around the membrane; and (c) if the sensor shows unstable readings or other sensor-related symptoms.

The Galvanic dissolved oxygen sensor is continuously reducing oxygen even when the display of the instrument is not active. This factor allows the sensor to be used with no warm-up period as soon as the instrument is powered on (instant on DO). However, because the sensor is “on” all the time, some solid from the oxidation of the zinc anode will form in the electrolyte within 1-2 weeks of activation. Small amounts of the solid will generally cause no performance problems, but excessive amounts may result in jumpy dissolved oxygen readings. The rate of solid formation is dependent on the type of membrane installed. The formation of solids based on membrane type typically form more rapidly with 5913 (1.25 mil PE), and less rapid with 5914 (2 mil PE).



*The Galvanic DO sensor solution will appear milky white after use but will NOT affect the accuracy of the sensor unless there is excessive build up. The color change is acceptable and normal as long as DO readings remain stable.*

At the time the membrane cap is changed, YSI recommends that you rinse the anode (silver shaft of the sensor) with purified water and wipe with a clean paper towel. If white deposits are evident on the anode after cleaning, YSI recommends that you remove this material by sanding the anode with the sandpaper disk included in the membrane kit. Follow the “Mechanical Cleaning” instructions under the Polarographic Silver Anode section.



**IMPORTANT:** Be sure to: (1) Use only the fine sanding discs provided and (2) Sand as mentioned in the above procedures. Not adhering to either of these instructions can damage the electrodes.



**WARNING:** DO NOT PERFORM THE POLAROGRAPHIC CHEMICAL CLEANING ON A GALVANIC SENSOR.

If this procedure is unsuccessful, as indicated by improper sensor performance, contact YSI Technical Support or the Authorized Dealer where you purchased the instrument.

## SENSOR STORAGE

---

### SHORT TERM STORAGE

The instrument is supplied with a grey calibration/storage sleeve that slides over the probe guard. The sleeve is used for short-term storage (less than 30 days). Be sure to keep a small amount of moisture (tap water) on the sponge in the sleeve during storage. This is simply done to maintain a 100% water saturated air environment which is ideal for short-term sensor storage. The sensors should not be submersed in water. The intent is to create a humid air storage environment.

### LONG TERM STORAGE


Dissolved oxygen sensors (Polarographic and Galvanic) should always be stored long term in a dry state. When storing for more than 30 days, remove the membrane cap and thoroughly rinse the sensor. Once the sensor has been rinsed either blow it dry with compressed air or allow to air dry completely. Use a clean, dry new membrane cap to screw over the sensor to keep it dry and to protect the anode and cathode.

After storing the sensor for a long period of time it is necessary to “condition” the sensor by putting a new membrane with electrolyte solution on the sensor.

Long Term Storage Temperature: -5 to 70°C (23 to 158°F)

# TROUBLESHOOTING

## ERROR MESSAGES

<i>Symptom</i>	<i>Possible Solution</i>
<b>Instrument will not calibrate;</b> instrument displays “Calibration Over”, “Calibration Under”, or “Unstable Reading” during calibration.	<ol style="list-style-type: none"><li>1) Verify barometer reading</li><li>2) Verify correct sensor and membrane type selection in the System Setup menu.</li><li>3) Calibration sleeve may not be 100% water saturated, ensure sponge is moisten</li><li>4) Ensure adequate sample movement if performing mg/L or ppm calibration</li><li>5) Allow sufficient stabilization time for dissolved oxygen and temperature AND wait at least 3 seconds before confirming a DO % or DO %Local calibration</li><li>6) Replace membrane and electrolyte</li><li>7) Clean sensor electrodes</li><li>8) Return system for service</li></ol>
<b>Instrument will not turn on,</b> a battery symbol  appears, or “Critical Shutdown” displays on the screen.	<ol style="list-style-type: none"><li>1) Low battery voltage, replace batteries</li><li>2) Batteries installed incorrectly, check battery polarity</li><li>3) Return system for service</li></ol>
<b>Barometer reads over/under,</b> Dissolved Oxygen and Temperature display Over/Undr, and pressing Cal key results in a Barometric Pressure Over/Undr message.	<ol style="list-style-type: none"><li>1) Barometer failure, return system for service</li></ol>

<i>Symptom</i>	<i>Possible Solution</i>
Instrument readings are inaccurate.	<ol style="list-style-type: none"> <li>1) Verify correct sensor/membrane type selection in the System Setup menu.</li> <li>2) Verify calibration, barometer reading, and salinity settings are correct and recalibrate.</li> <li>3) Verify accurate temperature readings.</li> <li>4) Sample temperature is over 45 °C, the temperature compensation range.</li> <li>5) Probe may not have been in 100% water saturated air during calibration procedure. Moisten sponge in calibration sleeve and recalibrate.</li> <li>6) Replace membrane and electrolyte, recalibrate.</li> <li>7) Clean sensor electrodes.</li> <li>8) Return system for service.</li> </ol>
Dissolved Oxygen values display Over or Undr on run screen.	<ol style="list-style-type: none"> <li>1) Verify correct sensor/membrane type selection in the System Setup menu.</li> <li>2) If using a polarographic sensor, allow instrument to warm up for 5 – 15 minutes before use.</li> <li>3) Sample O<sub>2</sub> concentration is more than 50 mg/L or 500%, or less than –0.02 mg/L or -0.3%.</li> <li>4) Verify barometer and salinity settings are correct and recalibrate.</li> <li>5) Verify accurate temperature readings.</li> <li>6) Replace membrane and electrolyte. Recalibrate.</li> <li>7) Clean sensor electrodes.</li> <li>8) Return system for service.</li> </ol>

Temperature values display Over or Undr on run screen.	<ol style="list-style-type: none"> <li>1) Sample temperature is less than -5° C or more than +55° C . Increase or decrease the sample temperature to bring within the allowable range.</li> <li>2) Return system for service.</li> </ol>
--	--

## S P E C I F I C A T I O N S

Parameter	Range	Resolution	Accuracy
Temperature	-5 to 55 °C *	0.1 °C	± 0.3 °C
	23 to 113 °F	0.1 °F	± 0.6 °F
Dissolved Oxygen	0 to 200% air saturation	1% or 0.1%, user selectable	± 2% of the reading or 2% air saturation, whichever is greater
	200 to 500% air saturation	1% or 0.1%, user selectable	± 6% of the reading
	0 to 20 mg/L	0.1 or 0.01 mg/L, user selectable	±2% of the reading or 0.2 mg/L, whichever is greater
	20 to 50 mg/L	0.1 or 0.01 mg/L, user selectable	±6% of the reading
Barometer	400.0 to 999.9 mmHg**	0.1 mmHg	± 5 mmHg within 5 °C of calibration temperature***

\* Automatic Dissolved Oxygen Temperature Compensation Range is -5 to 45 °C

\*\* Available barometer units include: mmHg, inHg, mbars, psi, or KPa

\*\*\* For operating temperatures below 10 °C or above 40 °C, the barometer must be recalibrated to maintain accuracy specification.

# ACCESSORIES / PART NUMBERS

<i>Part Number</i>	<i>Description</i>
6050020	Pro20
60520-1, -4, -10, -20, or -30	1, 4, 10, 20, or 30-meter cable with temperature and a port for Dissolved Oxygen
605202	Galvanic Dissolved Oxygen sensor
605203	Polarographic Dissolved Oxygen sensor
605780	ProBOD, Self-Stirring BOD sensor
603077	Flow cell – For use with any <i>Professional Series</i> Instrument
603056	Flow cell mounting spike
603075	Carrying case, soft-sided
603074	Carrying case, hard-sided
603069	Belt clip
063517	Ultra clamp
063507	Tripod
601205	Grease, o-ring
603062	Cable management kit
605978	Weight, sensor/cable, 4.9 oz
063019	Weight, sensor/cable, 24 oz, 3”
063020	Weight, sensor/cable, 51 oz, 6”
603070	Shoulder strap
5908	1.25, Yellow, Polyethylene membrane kit for Polarographic sensors
5909	2.0, Blue, Polyethylene membrane kit for Polarographic sensors
5913	1.25, Yellow, Polyethylene membrane kit for Galvanic sensors
5914	2.0, Blue, Polyethylene membrane kit for Galvanic sensors

# DECLARATION OF CONFORMITY

<i>Manufacturer:</i>	YSI Incorporated 1725 Brannum Lane Yellow Springs, Ohio 45387 USA
<i>Product Name:</i>	Pro20
<i>Model Numbers:</i>	
<i>Instrument:</i>	Pro20 (6050020)
<i>Cables:</i>	60520, 605780
<i>Sensors:</i>	605202, 605203
<i>Conforms to the following:</i>	
<i>Directives:</i>	EMC Directive 2004/108/EC
<i>Harmonized Standards:</i>	EN5011 :1998, A1:1999 Class B equipment EN61000-4-2 (ESD) EN61000-4-3 (RF radiated immunity) EN61000-4-4 (EFT) EN61000-4-6 (RF conducted immunity) EN61000-4-8 (50 Hz Radiated Susceptibility) FCC Part 15, Subpart B, Sections 15.107a & 15.109a, Class B
<i>Supplementary Information:</i>	This device complies with the requirements of the EMC Directive 2004/108/EC, and carries the CE mark accordingly. All performance met the continuous unmonitored operation criteria as follows: <ol style="list-style-type: none"> <li>1. ESD, IEC 61000-4-2, Performance Criterion B</li> <li>2. EM, IEC 61000-4-3, Performance Criterion A</li> <li>3. Burst, IEC 61000-4-4, Performance Criterion B</li> <li>4. Surge, IEC 61000-4-5, Performance Criterion B</li> <li>5. Conducted RF, IEC 61000-4-6, Performance Criterion A</li> <li>6. Voltage Interrupts, IEC 61000-4-11, Performance Criterion B</li> </ol>
<i>Authorized EU Representative</i>	YSI Hydrodata Unit 8, Business Centre West, Avenue 1 Letchworth, Hertfordshire, SG6 2HB UK



# RECYCLING

---

YSI takes seriously the commitment to reducing our environmental footprint in our course of doing business. Even though materials reduction is the ultimate goal, we know there must be a concerted effort to responsibly deal with materials after they've served a long, productive life-cycle.

YSI's recycling program ensures that old equipment is processed in an environmentally friendly way, reducing the amount of materials going to landfills.

Printed Circuit Boards are sent to facilities that process and reclaim as much material for recycling as possible.

Plastics enter a material recycling process and are not incinerated or sent to landfills.

Batteries are removed and sent to specialist battery recyclers for dedicated metals.

When the time comes for you to recycle, follow the easy steps as outlined at [www.yei.com/recycle](http://www.yei.com/recycle).

# CONTACT INFORMATION

---

## ORDERING & TECHNICAL SUPPORT

---

Telephone: (800) 897-4151  
(937) 767-7241  
Monday through Friday, 8:00 AM to 5:00 PM ET

Fax: (937) 767-9353 (orders)  
(937) 767-1058 (technical support)

Email: [environmental@ysi.com](mailto:environmental@ysi.com)

Mail: YSI Incorporated  
1725 Brannum Lane  
Yellow Springs, OH 45387  
USA

Internet: [www.ysi.com](http://www.ysi.com)

When placing an order please have the following information available:

YSI account number (if available)	Name and Phone Number
Model number or brief description	Billing and shipping address
Quantity	Purchase Order or Credit Card

## SERVICE INFORMATION

---

YSI has authorized service centers throughout the United States and Internationally. For the nearest service center information, please visit [www.ysi.com](http://www.ysi.com) and click 'Support' or contact YSI Technical Support directly at 800-897-4151.

When returning a product for service, include the Product Return form with cleaning certification. The form must be completely filled out for an YSI Service Center to accept the instrument for service. The Product Return form may be downloaded at [www.ysi.com](http://www.ysi.com) and clicking on the "Support" tab.

Item # 605597  
Rev B  
Drawing # A605597  
October 2008  
©2008 YSI Incorporated



## STANDARD OPERATING PROCEDURE MAINE VOLUNTEER RIVER MONITORING PROGRAM

### METHODS FOR USING THE YSI PROSOLO (ProSolo) OPTICAL DISSOLVED OXYGEN INSTRUMENT IN RIVERS AND STREAMS



**Note:** The mention of brand names does not constitute recommendation of a specific company.



## Volunteer River Monitoring Program (VRMP)

### Standard Operating Procedure Methods for using the YSI ProSolo Optical Dissolved Oxygen Instrument

**1. Applicability.** This standard operating procedure (SOP) is used by the Volunteer River Monitoring Program (VRMP) of the Maine Department of Environmental Protection’s Division of Environmental Assessment. It applies to the collection of dissolved oxygen (DO), temperature and specific conductivity from rivers and streams in Maine using the YSI ProSolo Optical Dissolved Oxygen Instrument.

**2. Purpose.** This purpose of this SOP is to provide standardized methods for volunteer groups to determine dissolved oxygen, temperature and specific conductivity of rivers and streams as an instantaneous reading using the YSI ProSolo Optical Dissolved Oxygen Instrument. This SOP also provides standardized methods for DEP VRMP staff to conduct quality assurance checks on volunteer groups’ equipment.

#### 3. Definitions.

**A. YSI.** Yellow Springs International, manufacturer of water quality monitoring meters.

**B. Optical Dissolved Oxygen Sensor (ODO).** Sensor that measures the light emission characteristics of a luminescent reaction.

**C. Sensor Cap.** Removable sensing cover that protects the sensor and is replaced once per year.

**D. Calibration.** Set of procedures established by the manufacturer to ensure that the meter is operating properly; a critical quality assurance step in meter preparation prior to use.

**E. Sensor Guard.** A protective cover for the ODO sensor cap.

**F. Calibration/Storage Sleeve.** Cover for the probe guard that keeps the probe in a moist atmosphere for storage or calibration.

#### 4. Responsibilities.

##### A. *Volunteer Monitors & Volunteer Groups*

- **Certification.** It is the responsibility of the individual obtaining this data to maintain current certification for the parameter(s) they collect if they wish their data to be entered into the VRMP database. Training will be provided to volunteers on an



annual basis by VRMP/DEP staff, and certification will last for one year from the date of training.

- **Data Recording.** It is the responsibility of the individual obtaining this data to record the results and additional qualifying information on current field sheets obtained from their affiliated watershed association or through the VRMP program of the DEP.
- **Data Quality Checks and Data Submission.** The data manager for the volunteer group will collect and enter volunteer field sheet data onto the appropriate computer file, perform quality assurance checks (refer to Section 5.10 of the Quality Assurance Program Plan), and submit data to the VRMP following protocols outlined in the volunteer group’s latest sampling and analysis plan (SAP) that has been approved by the VRMP.

#### ***B. Volunteer River Monitoring Program (VRMP) Staff***

- **Oversight of Volunteer Groups and Volunteers.** VRMP staff will oversee volunteer groups and volunteers through a variety of ways including maintaining an up-to-date VRMP quality assurance program plan (QAPP); reviewing sampling and analysis plans (SAPs) of the volunteer groups; providing annual training/certification sessions for volunteers; conducting quality assurance checks on volunteer data collection and data submitted by volunteer groups and laboratories; and uploading data into the DEP’s EGAD database. These tasks are described in greater detail in the VRMP’s latest QAPP.

### **5. Guidelines and procedures.**

#### ***A. YSI ProSolo Instrument Preparation.***

- **First time use.** Follow manufacturer’s instructions for preparing meter for setup. (refer to “1. Introduction”, pgs. 4-9; “2. Operation”, pgs. 10-29; and “3. Calibration”, pgs. 30-38).
  - If you plan to use the data storage features of the meter (in addition to manually writing down data on the VRMP field data sheet), then familiarize yourself with “Logging”, pg.16.
- **Beginning of field season.** Before each field season, volunteer monitoring groups shall conduct a full inspection of the meter. A newly charged battery pack shall be installed prior to the start of field sampling and additionally charged, as needed. A new sensor cap shall be installed if needed (according to the warranty period of the sensor cap). Refer to “Setup ODO”, pg. 19; “ODO Cap Prompt”, pg. 24; and “4.7



Optical Dissolved Oxygen Sensor”, pg. 52-55. A conductivity calibration shall be performed. Refer to “3.3 Conductivity”, pgs. 33-34.

- *Note of Caution:* Only use optical tissue or cotton swabs and water to clean the sensor cap. Do not use organic solvent solutions such as acetone or alcohol with the sensor cap and do not scrub the sensor cap or the sensor lens.

In addition, each meter “setup” should be equipped with the following items so that field repairs can be undertaken as necessary:

- Field data sheet
- Pencil with eraser
- **Prior to field sampling.** Before each field sample collection, the volunteer shall inspect the meter including an inspection of the condition of the sensor cap and battery pack.
  - (1) Battery pack should be checked for charge and/or expiration.
  - (2) The sensor cap should be kept clean. To clean, gently wipe away any fouling with a lens cleaning tissue that has been moistened with water.
  - (3) Be familiar with the testing, inspection, maintenance, and calibration considerations described in sections 5.6 through 5.8 of the VRMP QAPP (MDEP, 2009).
- **Dissolved Oxygen Calibration.** For best performance, a one-time calibration initialization should be performed when a new sensor is installed. Additionally, calibrations can be performed at the operator’s discretion but are not required. YSI recommends verifying the instrument’s calibration on a daily basis. To verify the instrument’s calibration, place the sensor in its calibration environment and check to see that the DO% is reading its calibration value based on the barometric pressure. Refer to “8.1 Appendix A DO% Calibration Values”, pg. 75.

Calibration can be performed manually using one of several options: Water saturated air, air saturated water, calibration to a solution with a known DO concentration (usually determined by a Winkler Titration) or zero calibration (followed by one of the previous options). For instructions, refer to “3.5 Dissolved Oxygen”, pgs. 35-36. Note: VRMP staff have found that an air saturated water sample method provides the best results.

- **Barometer Calibration.** The barometer is calibrated in the factory. If the barometer requires calibration, refer to “3.4 Barometer”, pg. 34.
- **Conductivity Calibration.** A conductivity calibration shall be performed prior to the start of field season as noted above.



## ***B. Dissolved Oxygen and Temperature Measurements.***

- **Sampling Period and Site Location.** Sampling period and site location information will be documented in the volunteer groups' SAPs (that require approval by the VRMP) which are submitted by the volunteer groups prior to any sampling. (Detailed information regarding how volunteer groups are to obtain and document site location information can be found in VRMP SOP-02 [Documenting Site Location].)
- **Sample Timing.** Dissolved oxygen data collected between dawn and 8 am are important for assessment of attainment of DO criteria within Maine's Water Quality Standards. But, except as naturally occurs, DO concentrations below the applicable DO criteria at any time of day signal non-attainment. If there are no DO concentrations below the criteria after 8 am, then data between dawn and 8 am must be collected to assess attainment of the criteria.
- **Re-Familiarize Yourself With the Meter and its User Manual.** Familiarize yourself with the basic operations, keypad and readouts of the meter. Refer to "2. Operation", pgs. 10-29.
- **General Sampling Protocol.**
  - Record site location on data sheet.
  - Remove probe from calibration/storage sleeve.
  - Submerge probe in the water at the site where you are monitoring, as described in your group's approved SAP. Move the probe in the sample to release any air bubbles.
  - Wait for the sensor to stabilize before recording the value on the field sheet.
  - Follow the instructions below measuring specific parameters.
  - Since there is no warm-up period associated with the YSI ProSolo and because the calibration is stable, you may wish to turn off the instrument between readings to conserve battery power.
- **Dissolved Oxygen Measurements.**
  - (1) Review and follow the instructions for taking measurements in "2.9 Taking Measurements", pg. 29.
  - (2) In most cases, only a limited amount of initial probe movement in the water is required for taking measurements (as opposed to older styles of dissolved oxygen meters which require continuous flow or movement across their membranes).
- **Temperature Measurements.**
  - (1) Temperature will display when taking Dissolved Oxygen measurements. Refer to "2.9 Taking Measurements", pg. 29.
  - (2) Record temperature value displayed on the screen.



- **Quality Control.**

(1) At the beginning of each field season, all VRMP staff and VRMP volunteers who collect dissolved oxygen and temperature data will have a training/refresher/certification session to (re)familiarize themselves with the contents of this SOP.

(2) For every volunteer, a field duplicate shall be obtained for all parameters for at least 10% of their own sampling efforts. A field duplicate will be collected for every 10 samples monitored.

(3) Refer to the VRMP quality assurance project plan (QAPP) for more QA/QC details.

## 6. Equipment Care.

### A. *Start of field season.*

1. Follow manufacturer's directions for preparation of a new probe or renewing probe in the spring. Be sure to replace sensor cap at the start of each sampling season or according to the warranty period of the sensor cap. (Refer to “ODO Sensor Cap”, pg. 53.
  - *Note of caution:* Avoid handling the face of the sensor cap. DO NOT use alcohol or other organic solvents to clean the face of the sensor cap. These solvents will destroy the sensor cap.
2. Recharge the battery pack at start of each sampling season.
3. Each D.O. meter should have the spare items for making repairs in the field. See section 5-A of this SOP for a list of necessary items.
4. If needed, clean the conductivity cell with the supplied soft brush. Refer to “3.3 Conductivity”, pg. 33.

### B. *Field Season*

1. Ideally the meter should be in water-resistant case with padding to protect it from damage.
2. Allow the case and contents to air-dry at end of each day. This may be accomplished by simply propping the lid open. When contents are very wet, remove the contents and spread out to facilitate drying.
3. Store the instrument within the optimal storage temperature range of 0-45° C.
4. Refer to “4. Maintenance and Storage”, pg. 49.
5. When the ODO sensor is not in use, it must be stored in a moist environment. Moisten the sponge in the calibration/storage sleeve with a small amount of clean water and place over the probe. If the cap dries out, it will need to be rehydrated. Refer to “4.7 Optical Dissolved Oxygen Sensor”, pgs. 52-53.

### C. *End of field season*

1. Completely dry meter, case, and all items in the case before storing.





2. Remove battery pack and store in a dry place ideally around 25°C.
3. Keep meter dry and at room temperature to prevent corrosion of electronic parts.
4. Record winterization date and equipment repairs in your volunteer group’s Equipment Log.
5. Label the meter and case as ‘WINTERIZED’ in an obvious manner (so users will know the current status of the unit).
6. Follow instructions for ODO Sensor long term storage. Refer to “4.7 Optical Dissolved Oxygen Sensor”, pgs. 53-53.

## 7. Specifications

Measurement	Range	Resolution	Accuracy
Temperature	-5°C - 70 °C	0.1 °C	±0.2 °C
Dissolved Oxygen (mg/L)	0-50 mg/L	0.01 or 0.1 mg/L (auto adjusts based on range)	0-20 mg/L, ± 0.1 mg/L or ± 1% of reading, whichever is greater.
			20-50 mg/L, ± 8% of the reading.
Dissolved Oxygen (%)	0-500%, air saturation	0.1% or 1% (auto adjusts based on range)	0 to 200%, ± 1% of the reading or ± 1% saturation, whichever is greater.
			200-500%, ± 8% of the reading.

## 8. Appendices.

- A. ProDIGITAL User Manual Professional Series Digital Handheld Meters. User Manual**  
 Item # 626973-01REF Revision F  
 YSI, a Xylem brand. 2018. Yellow Springs, Ohio.

## 9. References

### A. DEP Standard Operating Procedures:

- Document number #:DEPLW-0890: Dissolved Oxygen and Temperature, Instantaneous Measurement using Electronic Meters
- Document number #: DEPLW-0636: Protocols for using Hanna Dissolved Oxygen and Specific Conductance/Temperature/pH Meters

### B. Maine VRMP QAPP:

- Maine Department of Environmental Protection (MDEP). 2020. Maine Volunteer River Monitoring Program (VRMP) Quality Assurance Program Plan (VRMP). Document number#: DEPLW-0984



# ProDIGITAL User Manual

PROFESSIONAL SERIES DIGITAL HANDHELD METERS



a xylem brand

# ProDIGITAL

The information contained in this manual is subject to change without notice.

Effort has been made to make the information in this manual complete, accurate, and current.

The manufacturer shall not be held responsible for errors or omissions in this manual.

Consult [YSI.com](http://YSI.com) for the most up-to-date version of this manual.

---

Thank you for purchasing a YSI Professional Series Digital handheld meter. This manual covers setup, operation, and functionality of the ProDIGITAL handhelds which include the ProDSS and ProSolo.

ProDIGITAL Handheld features include:

- Digital smart probes that are automatically recognized by the instrument when connected
- Waterproof (IP-67) case
- Long-life rechargeable lithium-ion battery pack
- Color display and backlit keypad
- User-selectable cable options
- USB connectivity
- Global Positioning System (GPS) (optional on ProDSS)
- Depth sensor (optional on 4-port cable)
- Large memory with extensive site list capabilities
- Rugged enclosure with rubber over-molded case and military-spec (MS) connectors
- KorDSS data management software included with each instrument (Please see [Installation Instructions](#))

## Safety Information


Please read this entire manual before unpacking, setting up or operating this equipment. Pay attention to all precautionary statements. Failure to do so could result in serious injury to the operator or damage to the equipment. Do not use or install this equipment in any manner other than that specified in this manual.


The manufacturer is not responsible for any damages due to misapplication or misuse of this product including, without limitation, direct, incidental and consequential damages, and disclaims such damages to the full extent permitted under applicable law. The user is solely responsible to identify critical application risks and install appropriate mechanisms to protect processes during a possible equipment malfunction.

## Precautionary Symbols

**NOTE:** Information that requires special emphasis

**NOTICE:** Indicates a situation which, if not avoided, may cause damage to the instrument

 **CAUTION:** Indicates a potentially hazardous situation that may result in minor or moderate injury

 **WARNING:** Indicates a potentially or imminently hazardous situation which, if not avoided, could result in death or serious injury

## Product Components

Carefully unpack the instrument and accessories and inspect for damage. If any parts or materials are damaged, contact YSI Customer Service at 800-897-4151 (+1 937 767-7241) or the authorized YSI distributor from whom the instrument was purchased.

# TABLE OF CONTENTS

## 1. Introduction

- 1.1 Battery Use and Battery Life
- 1.2 Charging the Battery Pack
- 1.3 Battery Replacement
- 1.4 Connect the Handheld to the Cable Assembly
- 1.5 Sensor Installation/Removal

## 2. Operation

- 2.1 Keypad and Navigation
- 2.2 Startup
- 2.3 Navigation
- 2.4 Main Display Description
- 2.5 System Menu
- 2.6 Sensor Menu
- 2.7 Calibration Menu
- 2.8 Files Menu
- 2.9 Taking Measurements

## 3. Calibration

- 3.1 Calibration Setup
- 3.2 Depth
- 3.3 Conductivity
- 3.4 Barometer
- 3.5 Dissolved Oxygen
- 3.6 Turbidity
- 3.7 Total Algae
- 3.8 pH/ORP
- 3.9 ISEs

## 4. Maintenance and Storage

- 4.1 ProDIGITAL Handheld
- 4.2 4-Port Bulkhead
- 4.3 Sensor Guard
- 4.4 Depth Sensor
- 4.5 Temperature Sensor
- 4.6 Conductivity Sensor
- 4.7 Optical Dissolved Oxygen Sensor
- 4.8 Turbidity & Total Algae Sensors
- 4.9 pH/ORP Sensor
- 4.10 ISE Sensor
- 4.11 ProDSS Sensor Module Replacement

## 5. KorDSS Software

- 5.1 Introduction
- 5.2 Installing the Driver and Software

## 6. Accessories

- 6.1 Ordering

## 7. Safety and Support

- 7.1 Rechargeable Lithium-Ion Battery Pack
- 7.2 Service Information
- 7.3 Technical Support
- 7.4 Declarations of Conformity
- 7.5 Warranty

## 8. Appendices

- 8.1 Appendix A - DO% Calibration Values
- 8.2 Appendix B - Oxygen Solubility Table



THIS IS AN  
INTERACTIVE DOCUMENT

When viewing this document as an Adobe™ PDF, hovering your cursor over certain phrases will bring up the finger-point icon. Clicking elements of the Table of Contents, website URLs, or references to certain sections will take you automatically to those locations.

# 1. Introduction

## 1.1 Battery Use and Battery Life

ProSeries Digital handhelds use a rechargeable lithium-ion (Li-Ion) battery pack as a power source. The battery comes pre-installed in the handheld and ships at less than 50% full capacity. Battery life depends on use, enabled parameters, LCD brightness, and GPS use.

A new battery, that has been fully charged, is expected to last for the following durations at 25°C, with Sampling set to Auto, Backlight set to Auto, and GPS enabled:

- ProDIGITAL handheld only - 48 hours
- ProDSS with fully loaded 4-port cable assembly and 25% LCD brightness - 20 hours

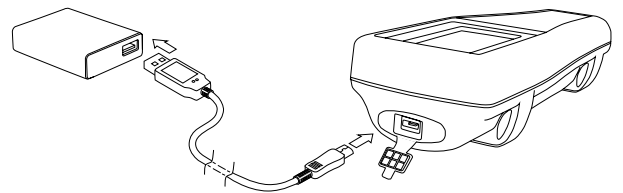
To increase battery life, enable manual sampling mode ([Sampling](#)). Manual sampling mode powers the sensor(s) on to take a measurement and then powers down to conserve battery life.

As with all lithium-ion batteries, battery life will decline over time and use. This decay should be expected. For the long-term health of the battery, a larger discharge is better than a small discharge between recharges.

## 1.2 Charging the Battery Pack

A USB cable is included with the handheld to charge the instrument battery pack and connect the instrument to a PC. The battery pack can be charged from the AC power adapter, directly from a computer USB connection or from an external, portable USB battery pack (sold separately, see [Accessories](#)).

Plug the USB connector into the AC power adapter, computer USB connector or external USB battery pack, then plug the micro USB connector into the handheld ([Figure 1](#)).



**Figure 1** Connecting the handheld to AC power supply

**⚠ WARNING:** Charge the battery pack in an open area away from flammable materials, liquids, and surfaces. Do not charge or handle a battery pack that is hot to the touch. Failure to follow the safety warnings and precautions can result in personal injury and/or instrument damage not covered under warranty. Read [Rechargeable Lithium-Ion battery pack safety warnings and precautions](#).

For the handheld to recognize that it is using AC power, you must start charging the handheld while it is turned on. After the instrument recognizes it is being charged, it can be turned off to finish charging.

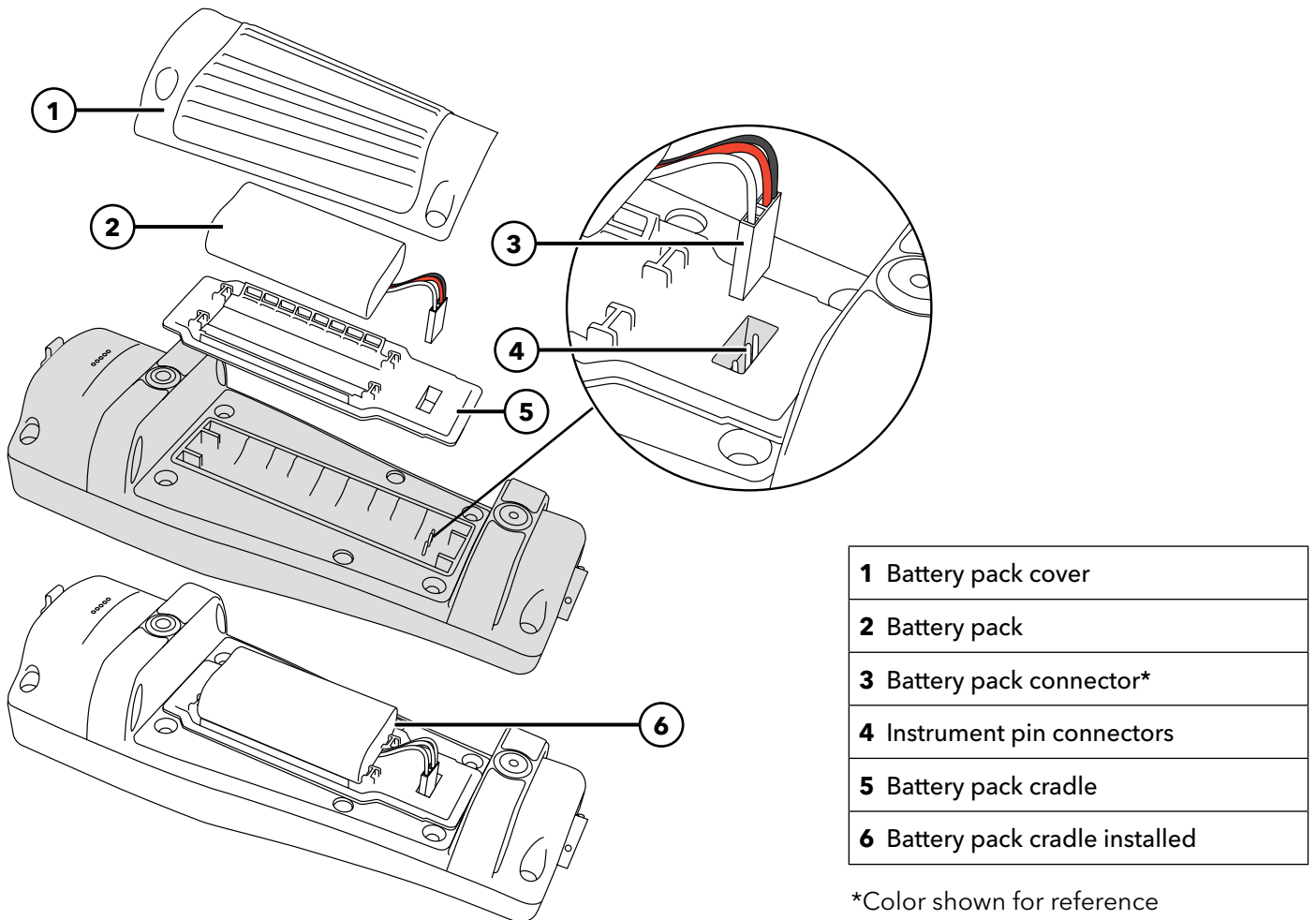
AC Charging	DC Charging
9 hr	14 hr

# 1.3

## Battery Replacement

1. Remove the battery pack cover by unscrewing (counter-clockwise) the four screws with a flat or Phillips head screwdriver (Figure 2). The retaining screws are captured into the battery pack cover and are not removable.
2. If replacing an existing battery pack, remove the Li-Ion battery pack and rubber battery pack cradle. With two fingers, grasp the battery pack connector and pull the connector straight up to disconnect and remove. Properly dispose of the old battery pack (See [Battery Disposal](#)).
3. Inspect the replacement battery pack and battery pack cradle for damage. Contact YSI [technical support](#) if there is any damage.
4. Correctly align and seat the battery pack cradle and battery pack into the instrument.
5. Align the battery pack connector wire terminals with the three instrument pins, then connect the battery pack to the instrument. Make sure that the three wire terminal connectors and three instrument pins are correctly aligned before connecting the battery pack connector. Incorrect installation can damage the battery pack connectors or instrument pins.
6. Install the battery pack cover, then hand tighten the cover screws with a screwdriver. DO NOT use any power tools. Make sure that the cover sealing surface is correctly aligned and free of any contamination or damage.

**NOTICE:** The battery cover does NOT need to make a compressed seal. Overtightening the cover screws can damage the battery cover and the handheld.



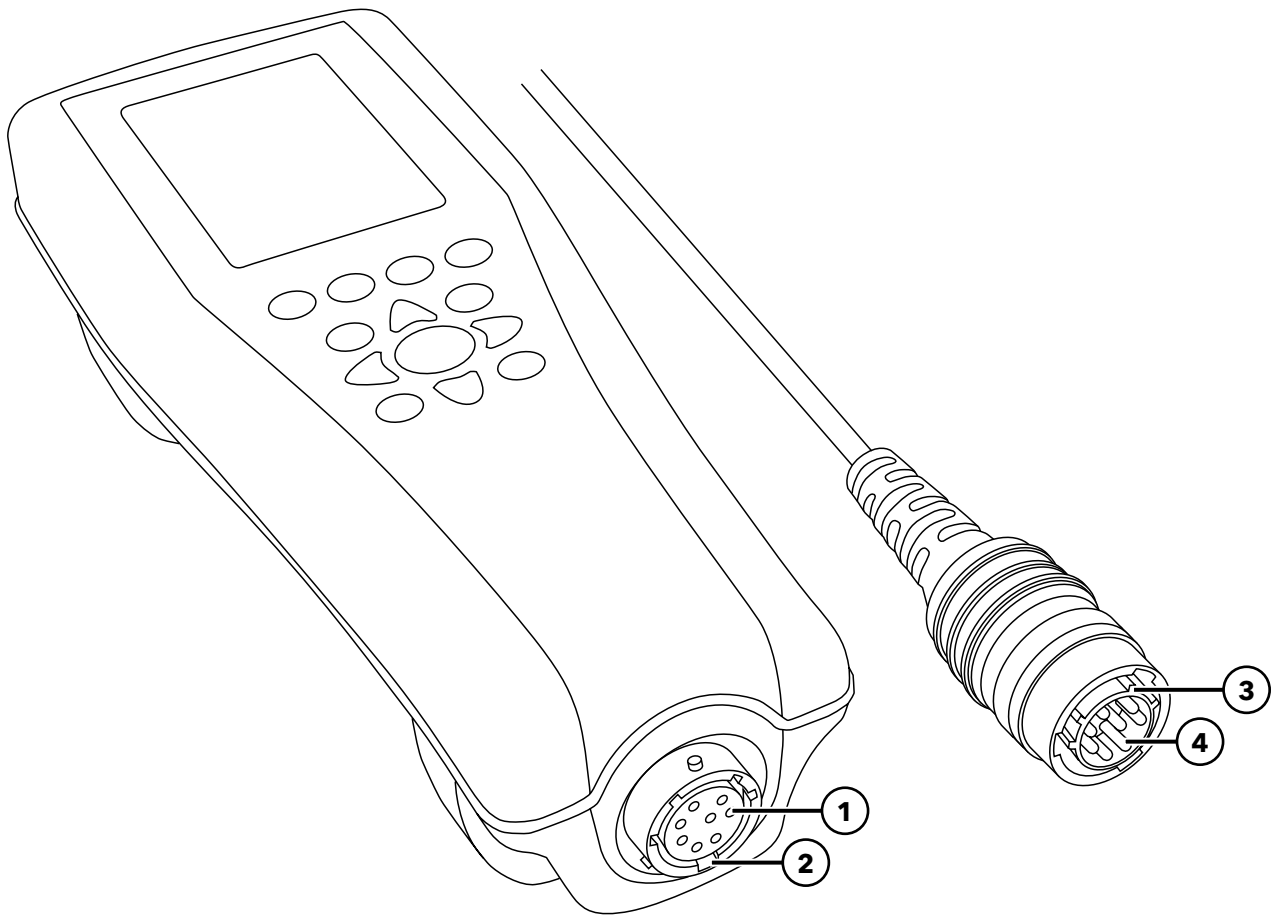
**Figure 2** Battery replacement

# 1.4

## Connect the Handheld to the Cable Assembly

The cable connectors are keyed for positive mating and to prevent connector damage (Figure 3). The handheld retains its IP-67 waterproof rating when the cable is disconnected. However, the connectors are not wet-mateable and should be clean and dry before connecting.

Align the keys on the cable connector with the slots on the handheld connector. Push together firmly, then twist the outer ring clockwise until it locks into place.



**Figure 3** Keyed connectors

<b>1</b> Handheld female connector	<b>3</b> Keyed area of connector
<b>2</b> Slotted area of connector	<b>4</b> Cable male connector

# 1.5

## Sensor Installation/Removal

Probe assemblies like the ODO/CT, ODO/T, and ProOBOD feature integral sensors. These sensors cannot be removed from the cable. Therefore, this section pertains only to the ProDSS 4-port cable.

### ProDSS 4-port Cable

ProDSS 4-port cables feature user-replaceable sensors. The ports on the bulkhead are universal, meaning that you can install any sensor into any port. A conductivity/temperature sensor must be installed for accurate measurement of all parameters except turbidity and TSS.

Bulkhead ports are numbered (Figure 4), so if multiple sensors of the same type are installed, the port number will be added to the Run screen display to clarify the measurement value of each sensor.

**NOTICE:** The bulkhead ports and sensor connectors are not wet-mateable. Make sure that the sensor connectors and bulkhead ports are clean and dry before sensor installation.

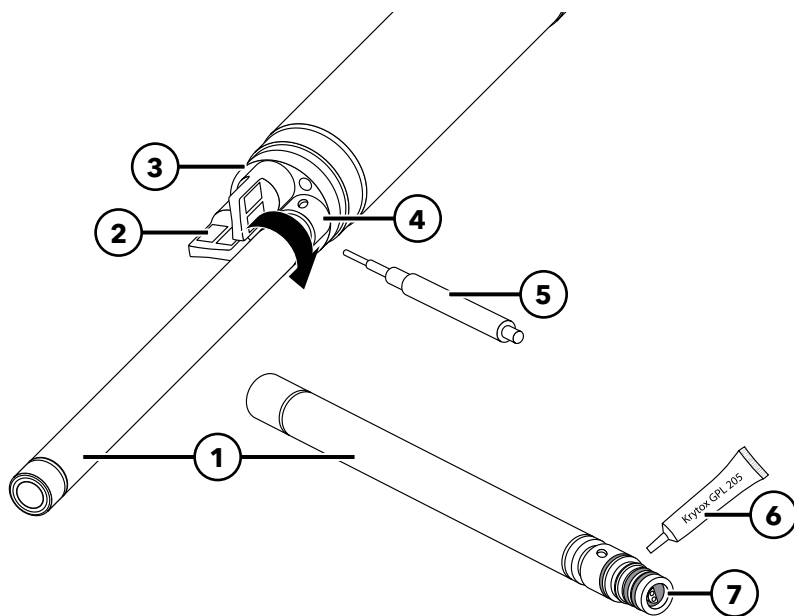


Figure 4 Sensor installation

1	Sensor
2	Port plug
3	Bulkhead
4	Sensor retaining nut
5	Sensor installation/removal tool
6	O-ring lubricant
7	Sensor port

### Sensor Installation

1. Remove the port cover shipped with the 4-port cable. This cover can be kept to protect the bulkhead ports from contamination during long-term storage.
2. Inspect each bulkhead port for contamination. If the port is dirty or wet, clean it with compressed air.
3. Apply a thin coat of o-ring lubricant to the sensor o-rings. Wipe off excess o-ring grease with a lint-free cloth.
4. Carefully align the sensor and bulkhead connectors by inserting the sensor into the port then gently rotating the sensor until the connectors align. Once aligned, push the sensor toward the bulkhead until the sensor seats in the port.

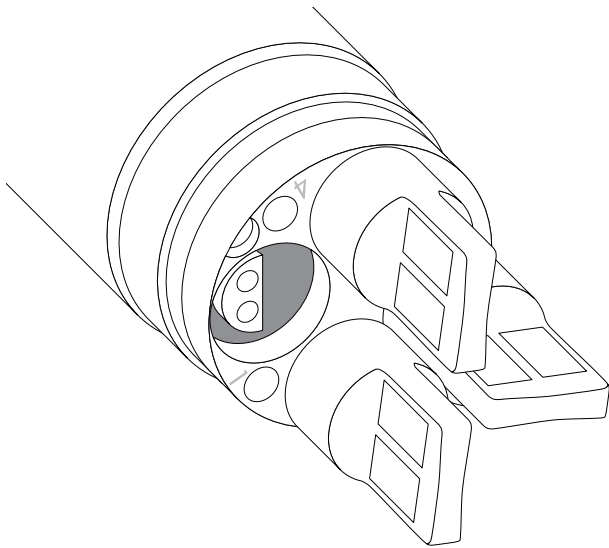


5. Carefully finger-tighten the retaining nut clockwise. If any resistance is felt, loosen the retaining nut completely to prevent cross-threading.
6. Use the sensor installation/removal tool to tighten the retaining nut clockwise until snug, about a  $\frac{1}{4}$  to  $\frac{1}{2}$  additional turn of the retaining nut. Be careful not to over-tighten the retaining nut.

**NOTICE:** Incorrect installation or over-tightening can cause damage to the sensor or bulkhead that is not covered by the warranty.

## Sensor Removal

To remove a sensor, insert the sensor installation/removal tool into the retaining nut, then rotate the retaining nut counterclockwise to loosen. After the retaining nut has been completely unscrewed from the bulkhead, pull the sensor straight out of the port and place it on a clean surface. Install a port plug if not reinstalling a sensor in the exposed port. Exposure to water can cause damage or corrosion to the bulkhead connectors not covered by the warranty.



**Figure 5** Sensor port plugs and port numbering (4-port cables)

## Port plugs

Port plugs and a tube of o-ring lubricant are included in the maintenance kit that ships with all 4-port cables.

## Installation

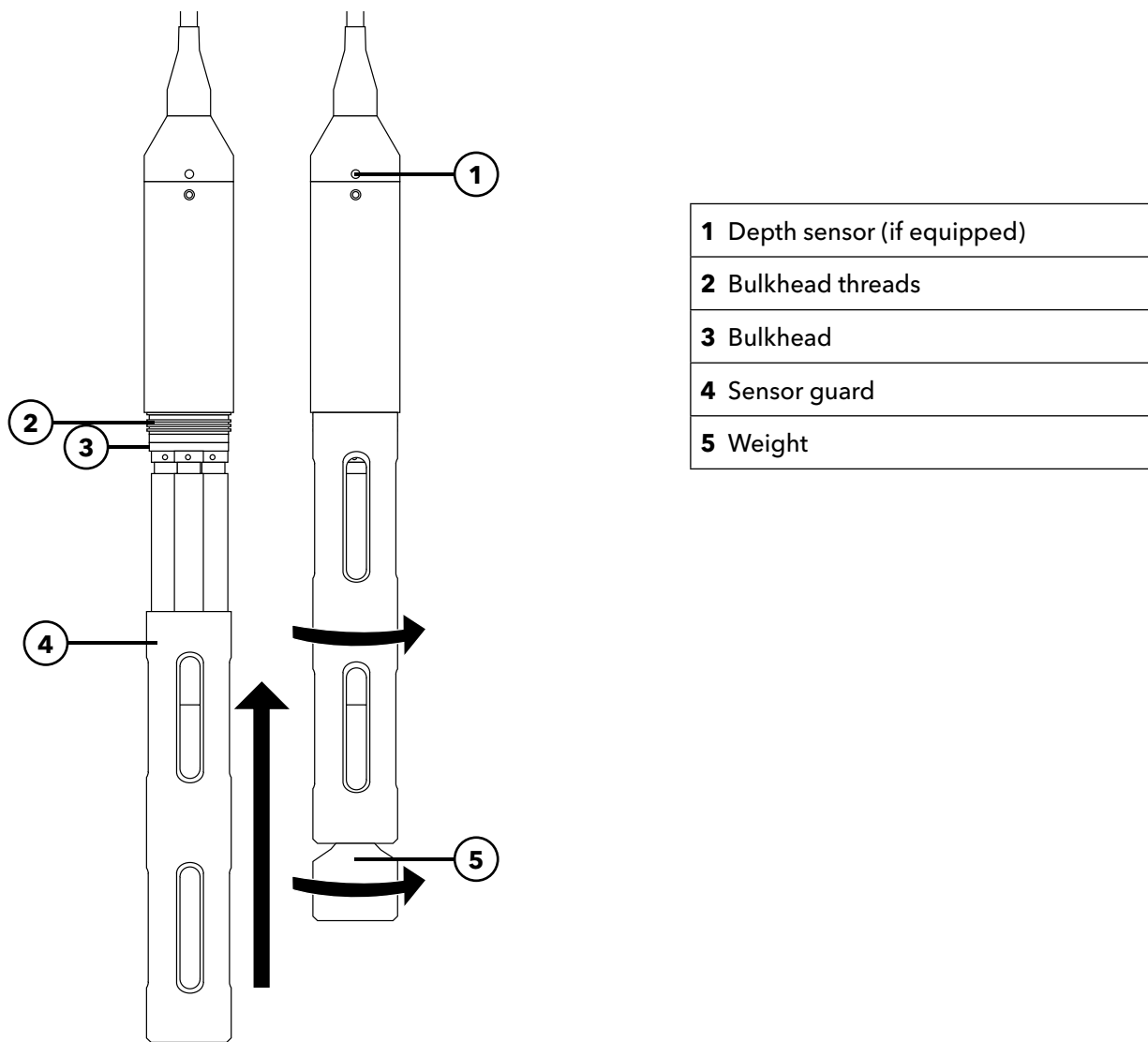
1. Apply a thin coat of o-ring lubricant to the o-rings on the plug port.
2. Remove any excess lubricant from the o-rings and port plug with a lint-free cloth.
3. Insert the port plug into the empty port and press until firmly seated.
4. Finger-tighten the port plug clockwise to install. If necessary, use the sensor installation tool to make sure that the plug is fully seated into the port. The o-rings will not be visible if a port plug is correctly installed. Do not over-tighten the port plug.

**NOTICE:** Do not submerge the bulkhead without a sensor or port plug installed in all ports.

## Sensor Guard and Weight Installation

1. Carefully slide the sensor guard over the bulkhead and attached sensors/port plugs. Push the sensor guard toward the bulkhead until the sensor guard threads align with the bulkhead threads.
2. Carefully hand-tighten the sensor guard clockwise. If any resistance is felt, loosen the sensor guard completely to prevent cross-threading. Incorrect installation may cause damage to the sensor guard or bulkhead that is not covered by the warranty.

## Sensor Guard and Weight Installation (continued)



**Figure 6** Sensor guard and weight installation on a 4-port cable assembly

## Sensor Guard Weights

To help stabilize the sensors when profiling at deeper depths, a 1 lb. sensor guard weight is supplied with 4-port assemblies 10 meters and longer. To attach the weight, carefully hand-tighten it clockwise on to the bottom of the sensor guard (Figure 6). If any resistance is felt, loosen the sensor guard weight completely to prevent cross-threading.

The bottom of the weight is threaded so that additional weights can be added if needed. YSI recommends installing no more than 5 lbs of weight on ProDIGITAL cables. See [Accessories](#).

**NOTE:** Do not have any weights installed on the sensor guard when calibrating using the calibration cup.

# 2. Operation

## 2.1 Keypad and Navigation

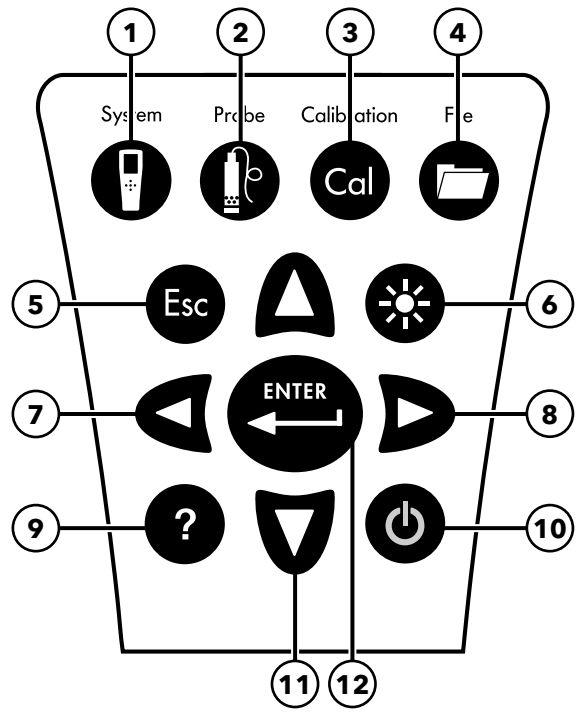


Figure 7 Keypad description

<p><b>1 System:</b> Opens the system menu. Use to adjust system settings.</p>	<p><b>7 Left arrow key:</b> Navigate left in an alpha/numeric entry screen. Push to return to previous menu in all screens except alpha/numeric entry. On the Run screen, push to show graphical representations of the displayed measurements.</p>
<p><b>2 Probe:</b> Opens the sensor menu. Use to setup sensors, change the units shown, select the sensor averaging mode, and turn on/off Auto Stable and GPS.</p>	<p><b>8 Right arrow key:</b> Navigate right in an alpha/numeric entry screen. On the Run screen, push to show graphical representations of the displayed measurements. In the View Data screen, push to view additional parameters in the data set.</p>
<p><b>3 Calibrate:</b> Opens the calibration menu. Use to calibrate sensors or restore default calibration.</p>	<p><b>9 Help:</b> Shows context sensitive help.</p>
<p><b>4 File:</b> Opens the file menu. Use to view logged data and calibration files, backup data to a USB stick, and delete data.</p>	<p><b>10 ON/OFF:</b> Turn on or turn off the instrument.</p>
<p><b>5 Exit/Escape key:</b> Exits to the Run screen. When in an alpha/numeric entry screen, returns to previous menu.</p>	<p><b>11 Up/Down arrow keys:</b> Scroll through menus or enter numbers and letters.</p>
<p><b>6 Backlight:</b> Turns the keypad backlight on or off for use in low light conditions.</p>	<p><b>12 Enter key:</b> Push to confirm selections. On the Run screen, push to log a single data point or start continuous data logging.</p>

## 2.2 Startup

Push the On/Off (⏻) key to turn on the handheld. If the handheld does not turn on, make sure that the battery is charged. Push and hold the ⏻ key for 1.5 seconds to turn the handheld off.

## 2.3 Navigation

The handheld contains menus to change user-defined options, functions, and parameters. Use the arrow keys (▲ and ▼) to highlight different options within menus and sub-menus, then push the Enter (↵) key to select the option. Push the left arrow (←) key to return to the previous menu.

Push the Exit/Escape (Esc) key to return to the Run screen. To enable or disable an option, highlight the option, then push the Enter (↵) key. Enabled functions appear as a circle with a dot (●) or a box with a check mark (☑). Disabled functions appear as a circle only (○) or an empty box (□).

### Alpha/Numeric Entry

When required, an alpha/numeric entry screen will be shown. Use the arrow keys to highlight a specific character and push the Enter (↵) key to select it for entry. When finished entering information, highlight **ENTER**, then push the Enter (↵) key to save the entry (Figure 8).

**NOTE:** When in an alpha/numeric screen, the ← key is for alpha/numeric navigation only. Push the Esc key to cancel and return to the previous menu.

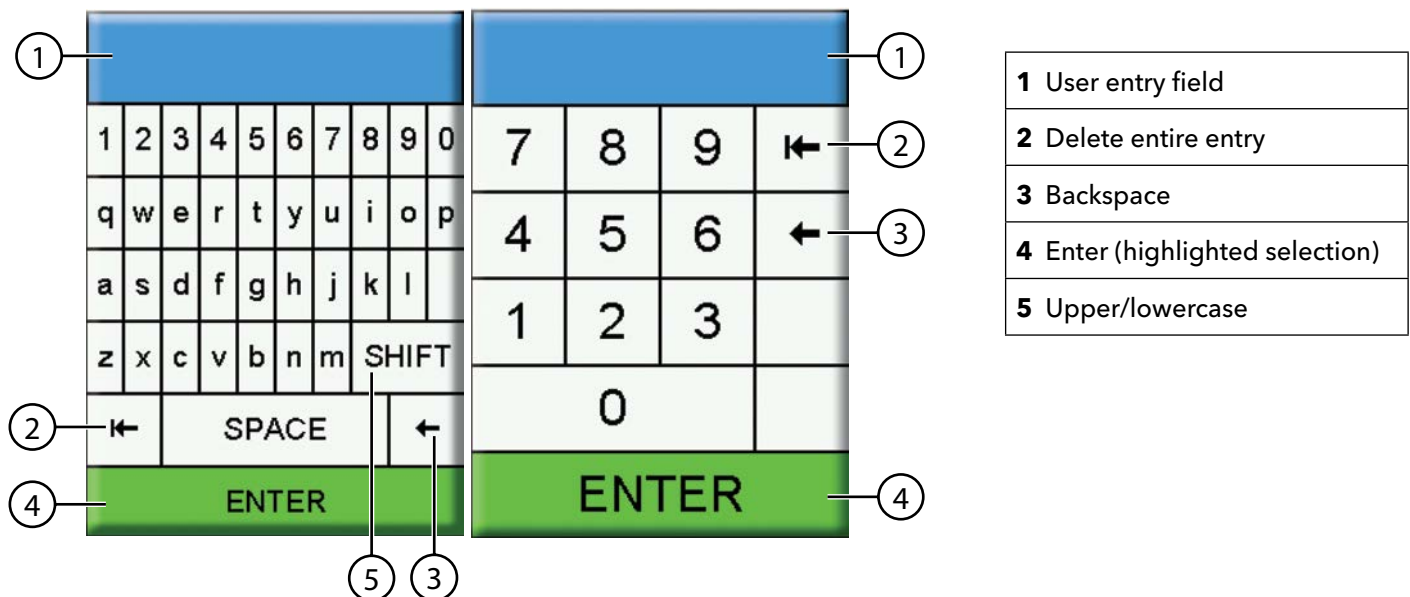


Figure 8 Alpha/numeric and numeric entry screens

# 2.4

## Main Display Description

The main display (Run screen) shows the current measurements and units as defined in the Sensor Display menu. If more measurements are selected than can be displayed on the Run screen, a scroll bar will be shown. Use the ▲ and ▼ arrow keys to view the additional measurements (Figure 9).

The message area shows status messages, error messages, and information about selected functions.

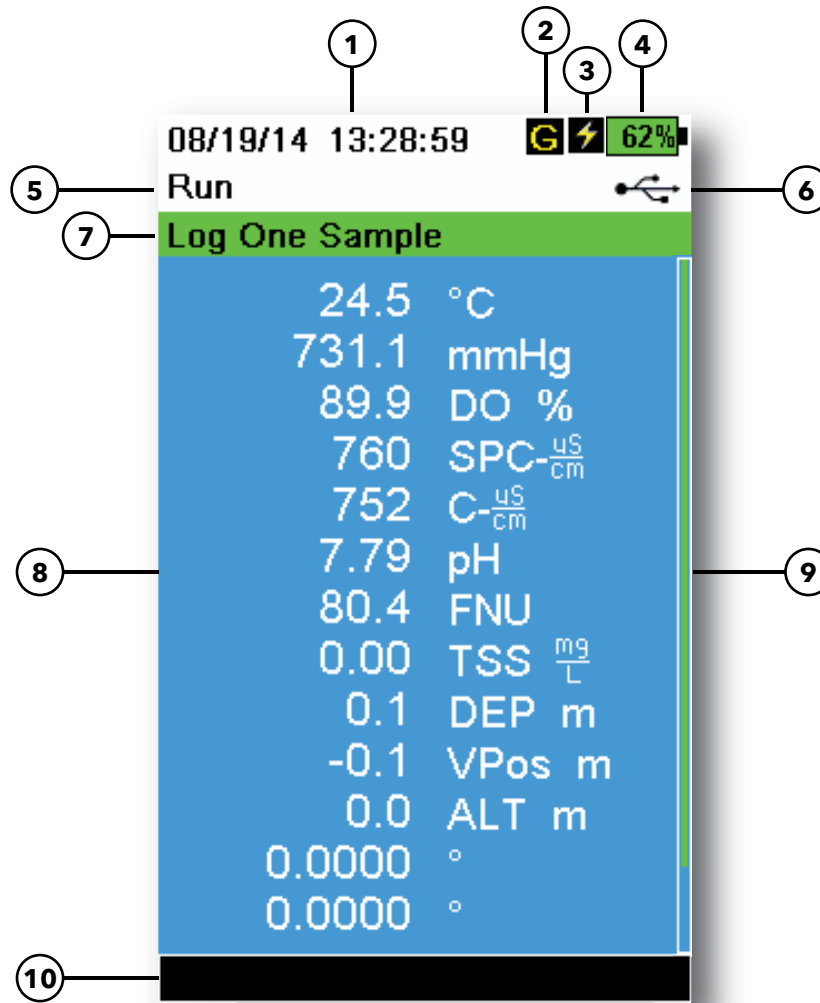




Figure 9 Main display example

1	Date/Time	6	USB/PC connection indicator
2	GPS signal indicator	7	Log or sampling (update measurements) prompt on Run screen (single or continuous)
3	Battery charging indicator	8	Displayed measurements
4	Battery charge %	9	Scroll bar
5	Current screen/menu	10	Message area

# 2.5

## System Menu

Push the System (  ) key to view and adjust instrument settings. Highlight a sub-menu then push the  key to view the sub-menu options (Figure 10).

Pre-defined or user-selected options are noted within brackets ( [ ] ).

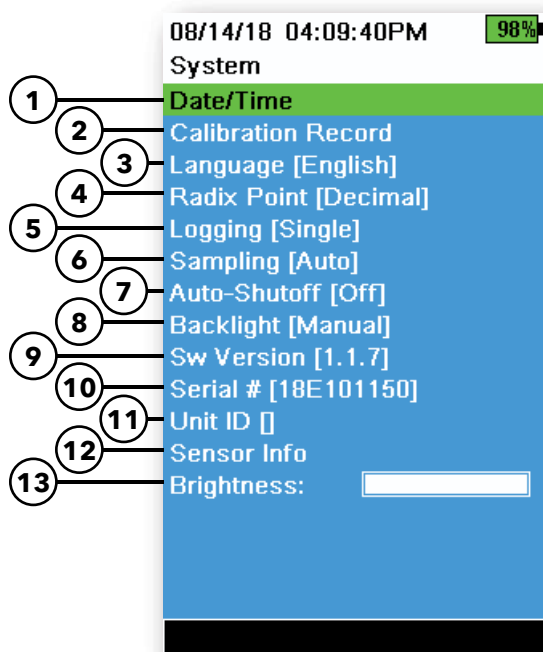


Figure 10 System menu

1	Set the Date and Time
2	Change the user-defined Calibration Options
3	Change the instrument Language settings
4	Change the Radix Point
5	Change the Logging options
6	Change the Sampling options
7	Set the handheld Auto-Shutoff time
8	Set the Backlight mode
9	View the Software Version
10	View the handheld Serial Number
11	View and adjust the Unit ID
12	View the Sensor specific information
13	Adjust the display Brightness

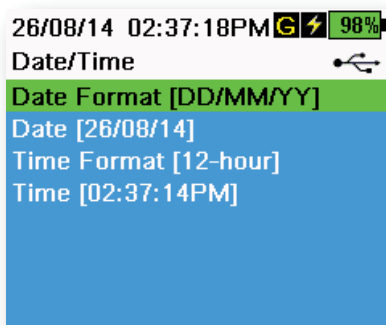


Figure 11 Date/Time

### Date/Time

 → Date/Time

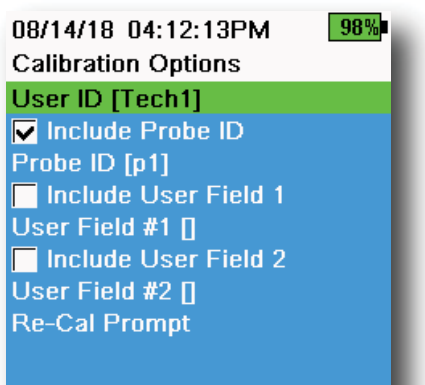
For accurate logging and calibration data, correctly set the date and time options (Figure 11). Select any of the following options to set the Date/Time.

#### Date/Time options:

- Set YY/MM/DD, MM/DD/YY, DD/MM/YY or YY/DD/MM date format
- Set the correct date
- Select 12 or 24 hour time format
- Set the correct time

## Calibration Record

Detailed sensor calibration information is stored for later review. The instrument's internal memory can save up to 400 individual calibration records. After 400 records, the instrument will overwrite previously stored calibration records, starting with the oldest. To prevent the permanent loss of calibration records, periodically download the calibration files to a computer using the KorDSS software.



**Figure 12** Calibration Options

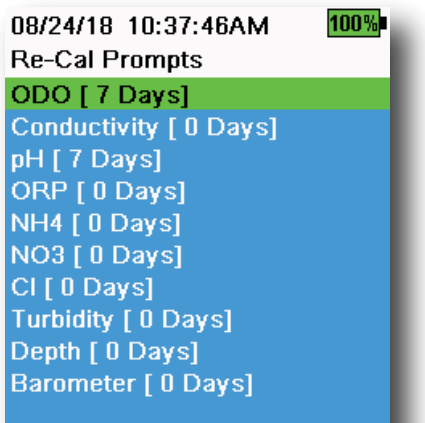
## Calibration Options

☰ → Calibration Record → Options

User ID, Probe ID, or User Field #1 or 2 can be user-defined for positive calibration file identification of:

- The person calibrating the instrument
- The sensor/cable serial number used during calibration (or other, user-defined Probe ID)
- Other user-specific identification (User Field #1 and #2) (Figure 12)

**NOTE:** User Field can be used to describe the condition of the probe. For example, new sensor or new ODO cap.



**Figure 13** Re-Cal Prompts

## Re-Cal Prompts

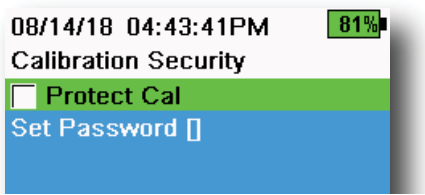
☰ → Calibration Record → Options → Re-Cal Prompts

Re-Cal Prompts provide a reminder to recalibrate a probe in the user-defined number of days (Figure 13). Select the desired sensor Re-Cal prompt, then enter the desired number of days before the Re-Cal prompt occurs. This reminder will be provided when the instrument is powered on and will reoccur every day until the sensor is re-calibrated.

Set the sensor value to zero (0) days (default) to turn off Re-Cal prompts.

## Calibration Security

 → **Calibration Record** → **Security**



**Figure 14** Calibration Security

The Calibration menu can be password protected to prevent accidental or unauthorized sensor calibration (Figure 14).

1. From the Calibration Record menu, select **Security**, then enter the default password "ysi123".
2. Select **Set Password** [ ] and change the default password.
3. Select the **Protect Cal** check box to password protect the Calibration menu.

**NOTE:** Write down and keep the password in a safe place. Contact YSI Technical Support if you lose the password ([Technical support](#)).

## Language

 → **Language**



**Figure 15** Language

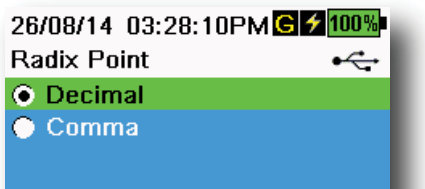
The instrument is shipped with English enabled. If a different language is desired and selected, the handheld will take approximately 10 to 20 seconds to enable the new language (during the first installation only).

### Optional languages:

- Spanish
- French
- German
- Italian
- Portuguese
- Norwegian
- Japanese
- Simplified Chinese
- Traditional Chinese
- Korean
- Thai

## Radix Point

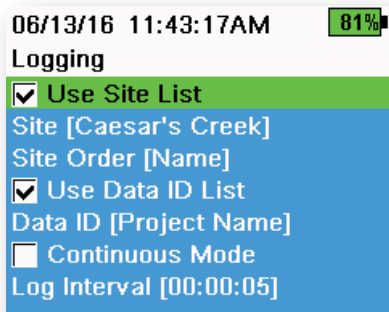
 → **Radix Point**



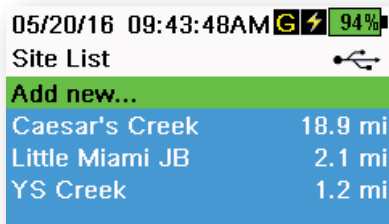
**Figure 16** Radix Point

The radix point can be changed to display a comma or a decimal in numeric displays (e.g. 1.00 becomes 1,00 when Comma is selected) (Figure 16).

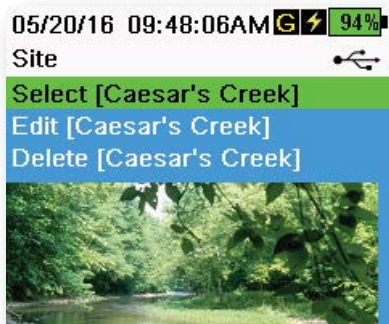




**Figure 17** Logging



**Figure 18** Site List



**Figure 19** Site

## Logging



The handheld can add a user-defined Site and/or Data ID to a data record if these functions are enabled under the Logging menu. A check mark in the box next to these features indicates they are enabled (Figure 17).


After selecting **Site** [ ] or **Data ID** [ ], the Site List or Data ID List will be shown (Figure 18). New entries can be created by choosing **Add new...**


If the handheld has a GPS signal, the current GPS coordinates will be auto-populated when creating a new site. If the handheld does not have a built-in GPS, the coordinates and altitude can be entered manually.


Sites can be listed in order of Name (*i.e.* alphanumeric order) or Distance from the current position (Figure 18).

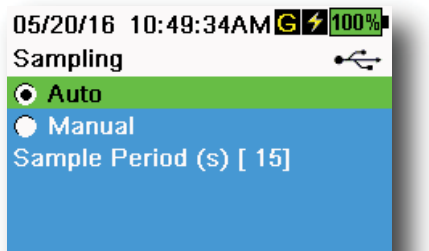
Choose an entry from the Site List or Data ID List to **Select**, **Edit**, or **Delete** (Figure 19). When selected, data recorded will be tagged with the specific site and/or data ID.

**NOTE:** *The Manage Sites menu in KorDSS Software can be used to send a picture of the Site to the instrument.*

**Continuous Mode** (Interval logging): Select the Continuous Mode check box and enter the user-defined Log Interval (in hours:minutes:seconds) to log samples continuously at the specified time interval. The Run screen will display **Start Logging...** when in Continuous Mode. Press  to begin logging.

**One sample logging:** Clear the Continuous Mode check box. The Run screen will display **Log One Sample**. A sample will be logged each time the  key is pushed when in the Run screen.

**NOTE:** *An option to change Site and/or Data ID (if enabled) appears once  is pressed to begin logging.*



**Figure 20** Sampling

## Sampling



Auto sampling mode continuously updates measurements on the display (Figure 20).

When in Manual mode, the instrument will take measurements for the duration of the user-defined Sample Period (in seconds) then “lock” or hold the readings on the display. The default sample period is 50 seconds, and can be adjusted from 15 to 60 seconds. Manual mode helps conserve battery power.

Once the measurements are locked, push the  key to log the held data, or the  key and then the  key to take a new measurement.

**NOTE:** When both Continuous Logging Mode and Manual Sampling mode are enabled, the handheld will power the sensors on and take measurements for 15 seconds before logging a data set.

## Auto-Shutoff



To conserve battery power, auto-shutoff powers off the instrument after a user-defined time period (in minutes). The auto-shutoff time can be adjusted from 1 to 255 minutes. Set to 0 (zero) to disable Auto-Shutoff.

## Backlight



In Automatic mode, the instrument display will dim 60 seconds after the last key was pushed. Once any key is pushed, the instrument display will return to the user-defined brightness setting and the keypad backlight will turn on. The screen will dim and the keypad backlight will turn off after another 60 seconds of inactivity.

In manual mode, the instrument display remains at the user-defined brightness and the keypad backlight is turned on and off by the Backlight key. Setting the backlight to manual mode is recommended for bright conditions.

## Software (Sw) Version



Sw Version shows the instrument's software version number. The latest instrument software and update instructions are available at [YSI.com](http://YSI.com). Instrument software can be updated through the KorDSS Software under the **Instrument and Sensors** tab.

## Serial #



Serial # shows the serial number of the handheld instrument. Note the serial number when contacting YSI support.

## Unit ID



Users can set a custom Unit ID. The Unit ID identifies the instrument in KorDSS Software.

## Sensor Info

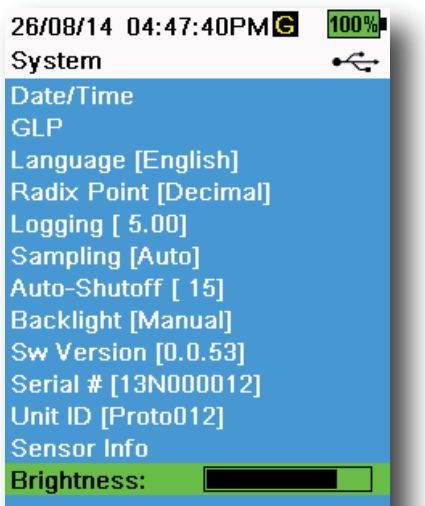


Sensor info shows measurement data, and hardware/software information for each component of the system: instrument, sensor, and bulkhead. Use the ▲ and ▼ arrow keys to scroll through the components.

## Brightness




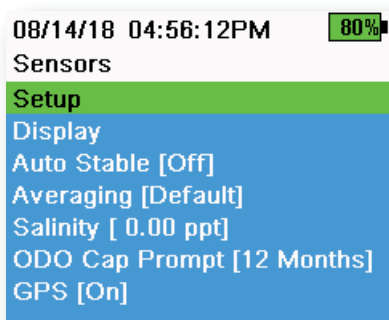
The screen brightness can be adjusted to accommodate lighting conditions and to conserve battery power (Figure 21). Use the ◀ and ▶ arrow keys to adjust the screen brightness.



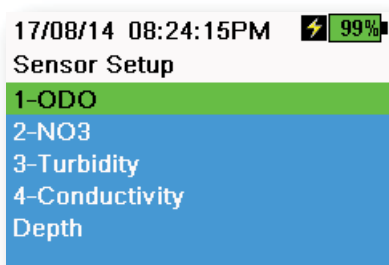
**Figure 21** Display Brightness

## 2.6 Sensor Menu

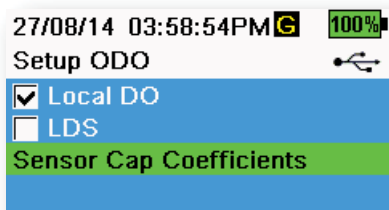
Use the Probe (  ) key to access the Sensor menu and change sensor settings (if applicable), enable the measurement units displayed on the Run screen, set Auto Stable parameters, change the sensor averaging mode, and if equipped, turn on/off GPS.





**Figure 22** Probe (Sensor) menu



**Figure 23** Sensor Setup

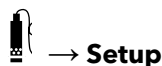


**Figure 24** Setup ODO

Push the  key to access the sensor menu (Figure 22). Highlight a sub-menu then push the  key to view sub-menu options.

Pre-defined or user-selected sensor settings are noted within brackets ([ ]).

### Sensor Setup



The Sensor Setup menu will show all sensors connected to the instrument (Figure 23). If a sensor is connected but is not listed on the Sensor Setup menu (<None> displayed), check the sensor and cable connections.

### Setup ODO

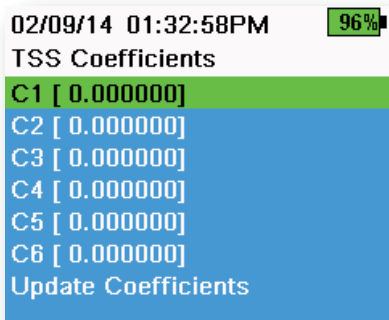


**Local DO:** Enable or disable localized DO% measurements. When enabled, the calibration value is set to 100% regardless of altitude or barometric pressure. When enabled, an L will be shown next to DO% on the run screen. DO mg/L measurements are unaffected when Local DO is enabled (Figure 24).

**LDS:** Last Digit Supression (LDS) rounds the DO value to the nearest tenth, e.g. 8.27 mg/L becomes 8.3 mg/L.

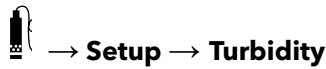
**Sensor Cap Coefficients:** The sensor cap coefficients must be updated after sensor cap replacement. Update the sensor cap coefficients using the coefficient sheet provided with the new sensor cap. Once updated, the coefficients are saved to the ODO sensor and do not need to be re-entered.

**NOTE:** The coefficients stay with the sensor even when used with different handheld meters.



**Figure 25** TSS coefficients

## Setup Turbidity



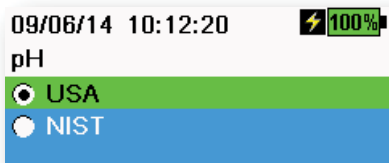
**TSS Coefficients:** Total Suspended Solids (TSS) can be measured if correlation coefficients are calculated in KorDSS.

To obtain these coefficients, collect turbidity data at the sampling site with corresponding grab samples. Analyze the samples in a lab to determine a true TSS measurement (mg/L). At least 2 and up to 6 value pairs of turbidity and TSS measurements can be used.

Correlation data must be collected for each unique sampling site, as this correlation is site-specific.

In KorDSS Software, enter the field-obtained turbidity measurements and the corresponding lab-obtained TSS measurements in the Instrument and Sensors menu. Coefficients can then be calculated with KorDSS and sent to the sensor.

**NOTE:** Although correlation coefficients can be entered directly into the handheld (Figure 25), only KorDSS Software can calculate the coefficients.

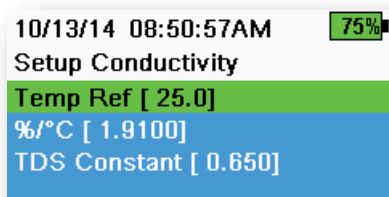


**Figure 26** Setup pH

## Setup pH

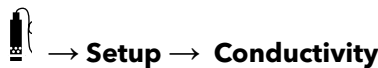


Select USA auto-buffer recognition (4.00, 7.00, and 10.00) or NIST auto-buffer recognition (4.01, 6.86, and 9.18) (Figure 26). Calibration values are automatically compensated for temperature for both buffer sets.



**Figure 27** Setup Conductivity

## Setup Conductivity



**Temp Ref:** Reference temperature is used to calculate temperature compensated specific conductance. All specific conductance values are compensated to the Temp Ref temperature. The default value is 25°C (Figure 27). Enter a new value between 15.00°C and 25.00°C.

**%/°C** (Percent per degree Celsius): The temperature coefficient is used to calculate temperature compensated specific conductance. The default is 1.91% based on KCl standards. Enter a new value between 0 and 4%.

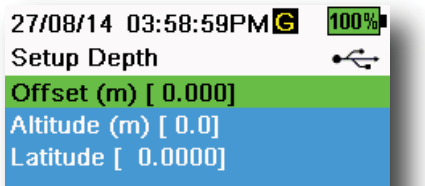
**TDS Constant:** This is a multiplier used to calculate an estimated Total Dissolved Solids (TDS) value from conductivity. The multiplier is used to convert specific conductance in mS/cm to TDS in g/L. The default value is 0.65. Enter a new value between 0 and 0.99.

## Setup Conductivity (continued)

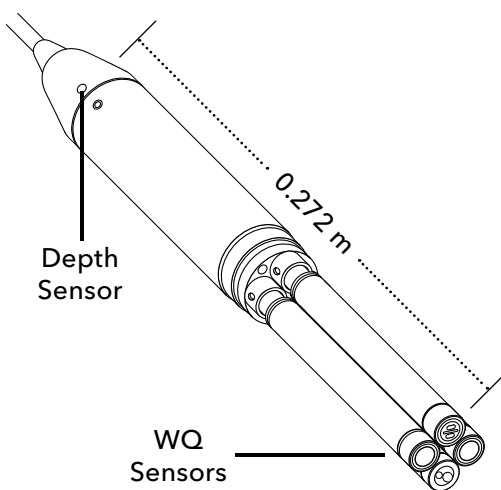
The TDS multiplier is highly dependent on the nature of the ionic species present in the water sample. To be assured of moderate accuracy for the conversion, you must determine a multiplier for the water at your sampling site. Use the following procedure to determine the multiplier for a specific sample:

1. Determine the specific conductance of a water sample from the site.
2. Filter a portion of water from the site.
3. Carefully measure a volume of the filtered water. Completely evaporate to yield a dry solid.
4. Accurately weigh the remaining solid.
5. Divide the weight of the solid (in grams) by the volume of water used (in liters) to yield the TDS value in g/L for the site.
6. Divide the TDS value in g/L by the specific conductance of the water in mS/cm to yield the conversion multiplier.

**NOTE:** If the nature of the ionic species at the site changes between sampling studies, the TDS values will be in error. TDS cannot be calculated accurately from specific conductance unless the make-up of the chemical species in the water remains constant.



**Figure 28** Setup Depth



**Figure 29** Distance of depth sensor to WQ sensors on 4-port cable

## Setup Depth

 → Setup → Depth

Cable assemblies with a depth sensor in the bulkhead can measure virtual vented depth. The virtual vented depth measurement allows for real time compensation for atmospheric pressure using the handheld's barometer.

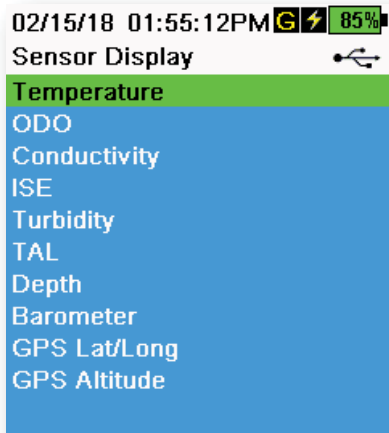
**Depth offset:** Depth offset can be used if referencing water elevation against a known value. If a depth offset is entered (in meters), the output value will shift by the value of the offset (Figure 28).

A common offset entered by the user is the depth sensor location relative to the rest of the WQ sensors. This value is 0.272 m on the 4-port cable (Figure 29).

**Altitude/Latitude:** To compensate for atmospheric pressure based on elevation and gravitational pull, enter the local altitude in meters relative to sea level and latitude in degrees where the instrument is sampling.

Latitude effect: Varying latitudes can cause up to a 200 mm change in depth from equator to pole.

Altitude effect: A 100 m change in altitude causes a 1.08 mm of change to the depth readings.



**Figure 30** Sensor Display

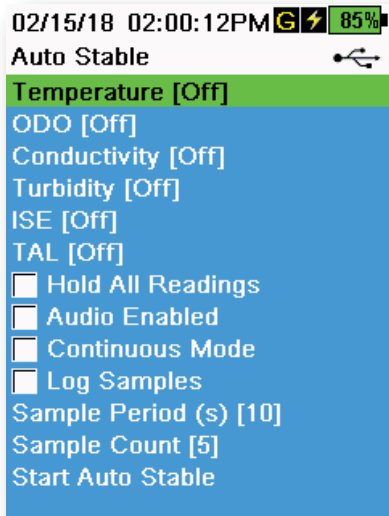
## Sensor Display



The Sensor Display menu determines the parameters and units that are shown on the Run screen (Figure 9). The Run screen will only show measurements for sensors that are attached to the cable bulkhead.

If more measurements are selected than can be displayed on one screen, a scroll bar will be shown. Use the ▲ and ▼ keys to scroll through the measurements.

**NOTE:** For depth profiling, enable Vertical Position under Depth Display to view the real-time position of the depth sensor in the water column. This is helpful in profiling applications to ensure the depth sensor is lowered to the desired depth without waiting for the depth data to stabilize.



**Figure 31** Auto Stable

## Auto Stable



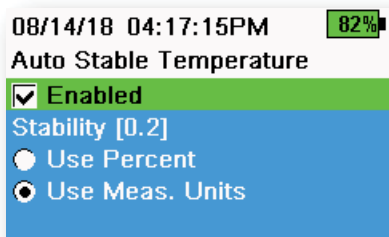
Auto Stable indicates when a measurement is stable. Sensors with Auto Stable enabled will have <sup>A</sup>s flash beside the measurement on the Run screen. <sup>A</sup>s will flash green when the measurement is stable.

Select a sensor to enable or disable Auto Stable (Figure 31). Then set the stability threshold parameters.

The Auto Stable stability threshold can be set by percent of measurement or in the units of measurement selected in the Sensor Display menu. Enter the stability value, then select **Use Percent** or **Use Meas. Units** (Figure 32).

This threshold is used to compare the last reading with the previous. The smaller the number entered in % or units, the longer it will take for the instrument to reach the auto stable criteria.

Example: For temperature in °C, if Measurement Units threshold is set to 0.2 and the temperature reading changes by more than 0.2 degrees, <sup>A</sup>s will continue to be red until the reading does not change by more than 0.2°C over the defined sample period and sample count.



**Figure 32** Auto Stable stability threshold

**Hold All Readings:** After all sensors have reached their stability criteria, the measurements will be held or 'locked' on the display. If disabled, the sensor measurements will continue to change in real time.

**Audio Enabled:** An audio alert will sound when stability is reached.

## Auto Stable (continued)

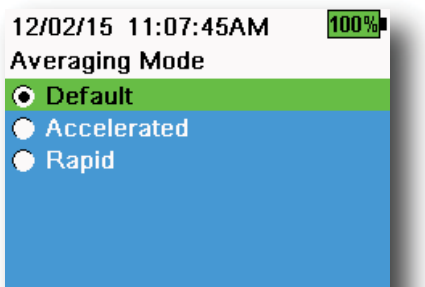
**Continuous Mode:** The handheld will continuously check sensor values against the stability criteria even after the sample period and sample count have been met.

**Log Samples:** Logs the sample/s defined by the Sample Period to memory.

**Sample Period:** Time interval between samples that are used to determine stability. Set the interval in seconds (1 to 900).

**Sample Count:** Number of consecutive samples required for stability (1 to 10).

Select Start Auto Stable to enable.



**Figure 33** Averaging

## Averaging

 → **Averaging** (Figure 33)

The averaging mode determines how the handheld will filter data. A smaller time frame for the rolling average window allows changes in the sensor's measurements to be more quickly observed, while a larger rolling window provides more stable measurement readings and a smooth result. Each averaging mode will decrease the time span of the rolling window if a large change in the sensor measurement is detected, allowing the handheld to adapt when an event occurs.

The **Default** mode provides optimum averaging for all sensors. This mode has up to 40 seconds of averaging on the sensors to curb spikes and outliers, resulting in more stable data.

In **Accelerated** mode, changes in sensor measurements are more quickly observed than default (approximately 10 seconds of averaging). This mode is recommended when the sensors are moving through the water, such as during profiling studies and most spot sampling applications.

**NOTE:** For profiling applications, enable Vertical Position under Depth Display to view unfiltered depth measurements. This helps to ensure the depth sensor is lowered to the desired depth without waiting for the averaged measurement.

In **Rapid** mode, sensor response is very fast (approximately 2 seconds of averaging), but the instrument will never settle on a single steady number. This mode is recommended when the sensors are moving quickly through the water, such as rapid profiling and towed applications.

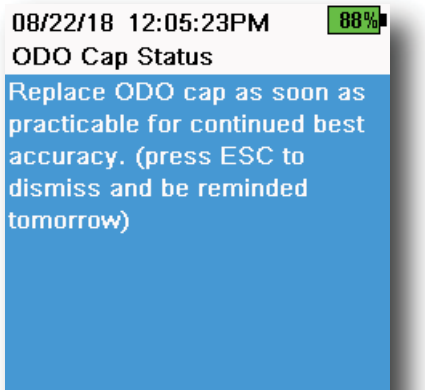


## Salinity



Salinity is determined by calculations derived from the conductivity and temperature sensors.

When a conductivity sensor is installed, the instrument will automatically use the salinity measurement for DO and “As Measured” will be displayed. If no conductivity sensor is installed (e.g. ODO/T cable assembly used), the salinity value will be user-selectable.



**Figure 34** ODO Cap Status

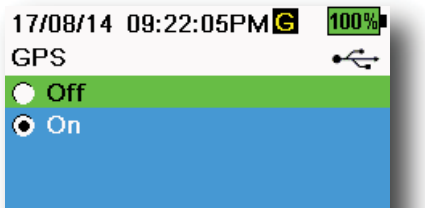
## ODO Cap Prompt



The handheld can remind users when it is time to replace the ODO Cap based on a user-defined interval (Figure 34). To set the reminder, select ODO Cap Prompt and **input a number in months**. YSI recommends enabling this setting to match the warranty period of the ODO Cap:

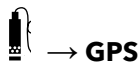
- ProDSS ODO Sensor Cap [SKU: 626890] = **12** months
- ODO Extended Warranty Sensor Cap [SKU: 627180] = **24** months

The handheld will automatically recognize the last time the ODO Sensor Cap coefficients were updated and alert the user when the Cap is due for replacement. To disable the prompt, simply enter **0** for the number of months.



**Figure 35** GPS

## GPS (Optional)





Some handhelds feature a built-in GPS. GPS turns the handheld Global Positioning System On or Off. The **G** symbol is shown when a GPS signal is received (Figure 35).

When enabled, the GPS coordinates will be saved with the Calibration Record and logged data. Note that the battery will drain more rapidly when GPS is enabled than when it is not enabled.

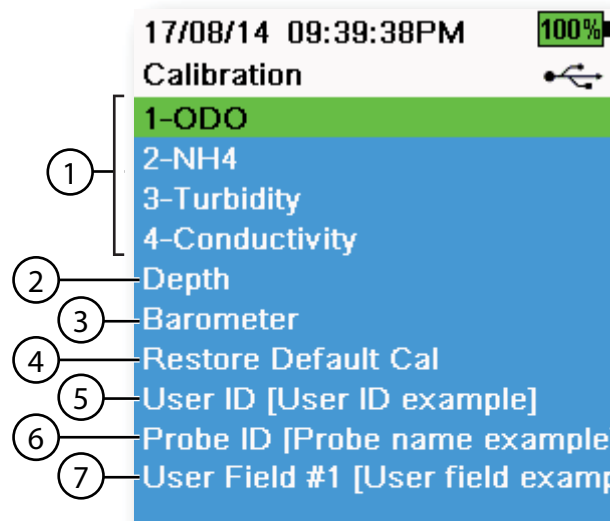
**NOTE:** GPS data will be most accurate when there is a clear line of sight to satellites. It may be difficult for the handheld to receive a good GPS signal when under canopy or indoors.

# 2.7

## Calibration Menu

Push the Calibrate (  ) key to access the Calibration menu (Figure 36). Highlight a sub-menu then push the  key to view sub-menu options. Pre-defined or user-selected parameters are noted within brackets ( [ ] ). Refer to the Calibration section for sensor specific calibration procedures.



**NOTE:** User ID, Probe ID, and User Field #1 and #2 can be enabled in the **Calibration Settings** under the System menu.



**Figure 36** Calibration menu

<b>1</b> Sensors connected	<b>5</b> User ID
<b>2</b> Optional Depth sensor calibration	<b>6</b> Probe ID
<b>3</b> Barometer calibration	<b>7</b> User Field #1
<b>4</b> Restore Default Calibration - restores specified sensor to factory default	

## 2.8 Files Menu

Push the File (  ) key to access the Files menu (Figure 37). Highlight a sub-menu then push the  key to view sub-menu options.

Use the Files menu to view, delete or backup logged data or the calibration file. Data can be filtered by a specific date and time range and by user-created Site and Data ID lists.

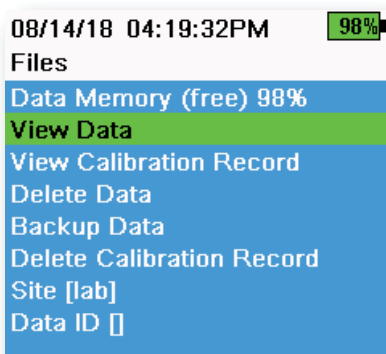


Figure 37 Files menu

**Data Memory:** (free) % shows the remaining memory available. Download or delete data to free available internal memory.

The Site List and/or Data ID List can be seen by selecting **Site [ ]** or **Data ID [ ]**. To enable the use of Site and/or Data ID when logging data, select **Logging** under the System menu.

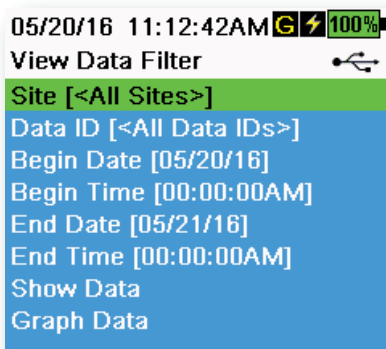


Figure 38 View Data Filter

### View Data Filter

 → **View Data**

Enter the desired filter criteria, then select **Show Data** or **Graph Data** to view the tabular or graphical data. If necessary, use the arrow keys to scroll through the data (Figure 38 and Figure 39).

**Site:** View data from one site or all sites.

**Data ID:** View data from one ID or all IDs.

**Begin/End:** View data within specific date and time ranges.

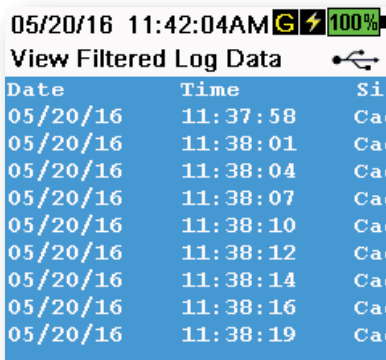
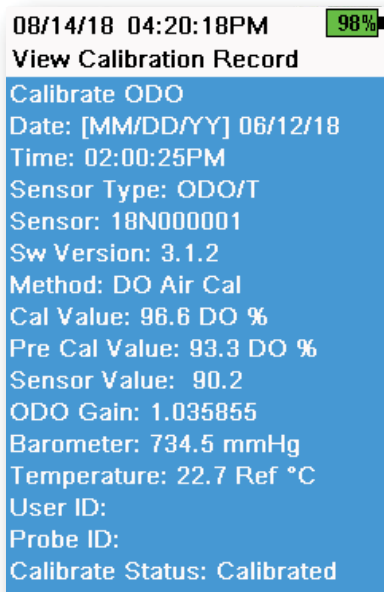


Figure 39 View Filtered Log Data



**Figure 40** View GLP

## View Calibration Record



Select **View Calibration Record** to show the stored sensor calibrations (Figure 40).

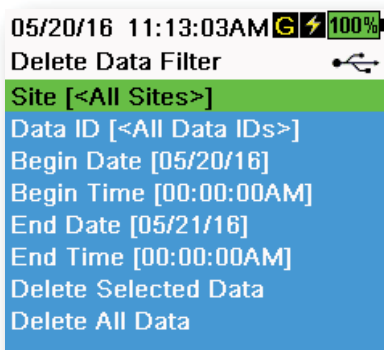
Use the arrow keys to scroll through the calibration file data.

## Calibration Information

### Information in each calibration record:

- Sensor calibrated
- Date/time stamp
- Sensor ID
- Sensor serial #
- Sensor software version
- User ID (optional)
- Probe ID (optional)
- User Fields #1 and #2 (optional)
- Calibration status
- Calibration value
- Temperature

Depending on the parameter, a calibration record may include additional information such as the Conductivity cell constant, ODO gain, ORP offset, and pH slope.



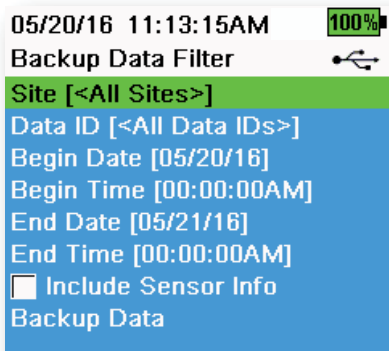
**Figure 41** Delete Data Filter

## Delete Data

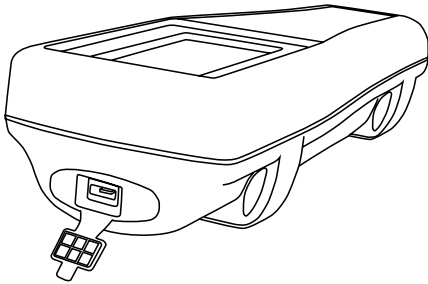


Enter the desired filter criteria, then select **Delete Selected Data** to *permanently* delete the data (Figure 41).

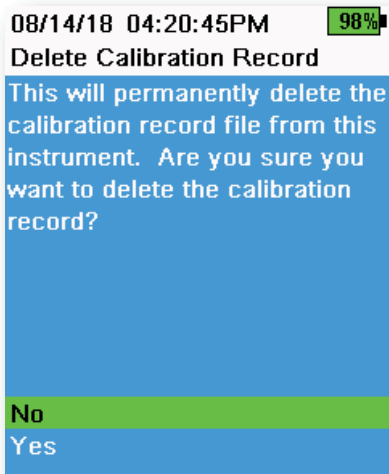
Select **Delete All Data** to permanently delete all logged data from the handheld.



**Figure 42** Backup Data



**Figure 43** Micro USB female connector



**Figure 44** Delete Calibration Record

## Backup Data



This function allows you to backup logged data to a flash drive based on Site, Data ID, and log date (Figure 42). A USB female to micro USB male adapter is included with new instruments for this data backup.

**NOTE:** The USB storage device must be formatted as FAT32, not NTFS or exFAT. The handheld will only support FAT32.

If the box next to “**Include Sensor Info**” is checked, each data set will be sent to a flash drive as a separate file with sensor serial number and sensor software information included. If the box is not checked (default), all data sets will be sent in a single backup file with no sensor serial number or sensor software information.


**NOTE:** It is suggested to send data to the USB flash drive as a single file (i.e. box is not checked) unless this sensor information is needed. This makes importing the data much faster and easier.

Once the filter settings are configured, select **Backup Data** to send the data to a flash drive. The data is exported in a CSV file.

If the data backup is not successful, ensure the correct filter criteria are selected and the USB connection indicator can be seen at the top of the screen (Figure 9).

## Delete Calibration Record





To permanently delete the Calibration Record file from the instrument, select **Yes**, then push the  key (Figure 44).


## 2.9

# Taking Measurements

For the highest accuracy, calibrate the sensor(s) before taking measurements.

1. Create Site and Data ID lists for logged data (if applicable).
2. Set the logging method (single or interval).
3. Set the Auto Stable parameters (if applicable).
4. Verify that the sensors and/or port plugs are correctly installed in all bulkhead ports.
5. Install the probe guard.
6. Insert the probe into the sample. Make sure the probe is fully submerged.
7. Move the probe in the sample to release any air bubbles and to provide a fresh sample to the sensors.
8. Wait for the sensor/s to stabilize in the sample.
9. On the main run screen, press  to begin logging (single or interval) (See [Logging](#)).

**NOTE:** An option to change Site and/or Data ID (if enabled) appears once  is pressed to begin logging.

10. To stop continuous logging, simply press  key again.

# 3. Calibration

ProDIGITAL sensors (except temperature) require periodic calibration. Calibration procedures follow the same basic steps with variations for specific parameters. Before calibration, adjust *Calibration Record* settings under the **System** menu if applicable to user requirements. Set up sensor options, settings, and coefficients as applicable.

## 3.1 Calibration Setup

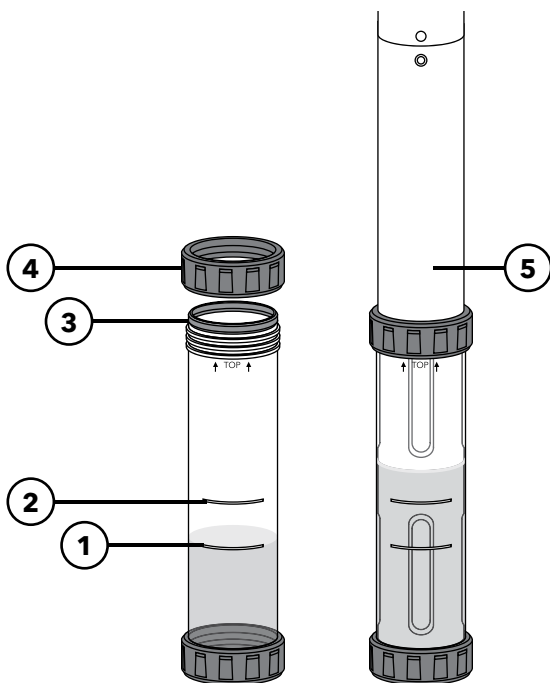
Make sure the calibration cup, sensor guard, and all sensors are clean. YSI recommends installing the sensor guard before placing the sensors into the calibration cup.

For highest data accuracy, thoroughly rinse the calibration cup and sensors with a small amount of the calibration standard for the sensor to be calibrated. Discard the rinse standard, and proceed with a fresh standard.

Be careful to avoid cross-contamination with other standards between calibrations by thoroughly rinsing with DI water and drying the calibration cup and sensors.

Ensure the calibration cup gasket is correctly seated. Loosely install the retaining nut on the cup. Slide the calibration cup over the sensors and sensor guard and tighten the retaining nut (Figure 45).

### Calibration Cup Installation for 4-Port Cable Assemblies

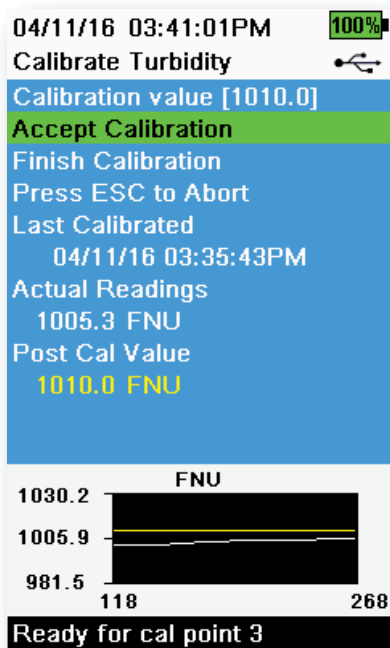


<b>1</b> Fill line one (for all calibration solutions except for conductivity)
<b>2</b> Fill line two (for conductivity calibration solution)
<b>3</b> Gasket
<b>4</b> Retaining nut
<b>5</b> Calibration cup installed

It takes 170 mL of solution to fill the calibration cup to line 1, while it takes 225 mL to fill to line 2.

**Figure 45** Calibration cup standard volume (4-port cable)

## Calibration Setup (continued)



**Figure 46** Layout of calibration screen

### Calibration Screen Layout

The calibration screen has the same basic layout for each parameter (Figure 46).

**Calibration value:** This is the value the sensor will be calibrated to. The Yellow Line on the graph corresponds to this value.

**Accept Calibration:** Select this to calibrate the sensor to the calibration value.

**Finish Calibration:** This option is only available with multi-point calibrations (*i.e.* pH, ISE, turbidity, PC, PE, and chlorophyll). Finishes the calibration by applying previously accepted points.

**Press ESC to Abort:** Press the ESC key to leave the calibration. The sensor will not be calibrated to any points. The last successful calibration will be used.

**Last Calibrated:** View the date and time of the last successful sensor calibration.

**Actual Readings:** This shows the current measurement value on the Run screen. The White Line on the graph corresponds to this value. Observe the White Line to ensure the measurement is stable before choosing Accept Calibration.

**Post Cal Value:** This is the same as the calibration value. This will be the measurement value in the current solution after the calibration is finished.



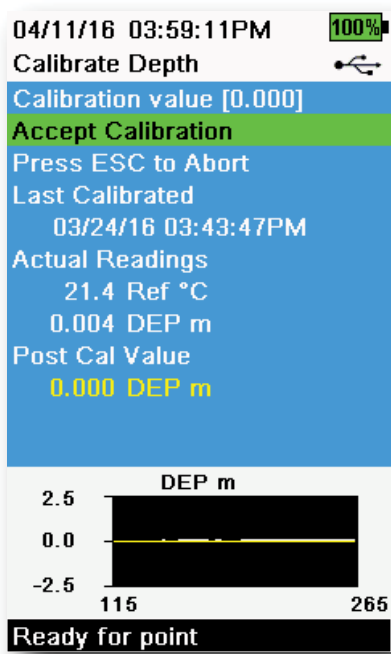
## 3.2 Depth

**NOTE:** This calibration option is available only if your bulkhead is equipped with a depth sensor.

Depth is calculated from the pressure exerted by the water column minus atmospheric pressure. Factors influencing depth measurement include barometric pressure, water density, and temperature. Calibration in the atmosphere “zeros” the sensor with respect to the local barometric pressure.


YSI recommends calibrating depth at the location of measurement. A change in barometric pressure will result in a zero shift unless the transducer is recalibrated to the new pressure.

If applicable, enter the depth offset to set the depth measurement to something other than zero. Enter the altitude and latitude of your sampling location to increase the accuracy of your depth measurement.



**Figure 47** Calibrate Depth

### Depth Calibration

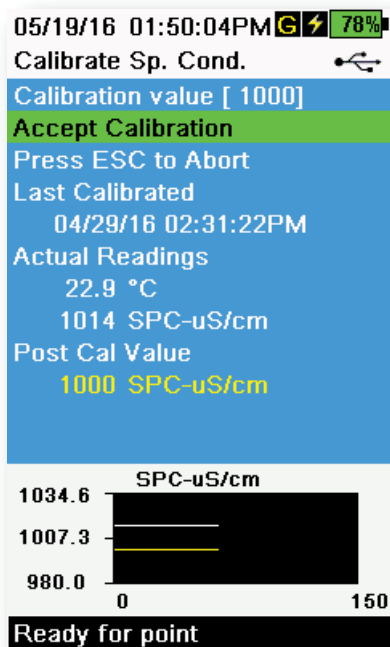
1. Make sure that the depth sensor is clean and dry in air, not immersed in any solution. For best results, keep the bulkhead still and in one position while calibrating.
2. Push the  key, then select **Depth**. The **Calibration Value** is set to 0.000 and should not be changed for air calibrations, even if using an offset.
3. Observe the actual measurement readings for stability (white line on graph shows no significant change for 40 seconds), then select **Accept Calibration** (Figure 47).

If the depth offset is used, the depth measurement will be adjusted after calibration.

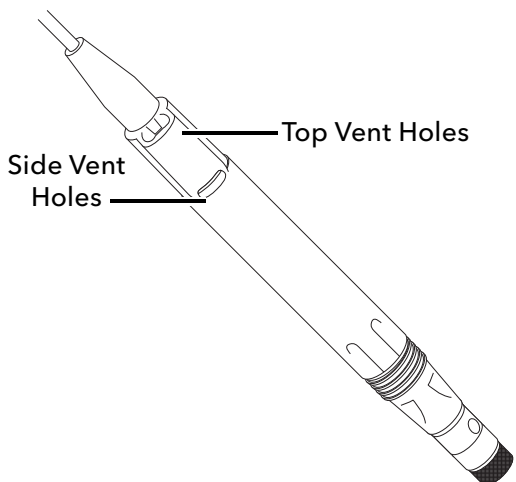
## 3.3 Conductivity

The conductivity/temperature sensor can measure and calculate conductivity, specific conductance (temperature compensated conductivity), salinity, non-linear function (nLF) conductivity, TDS, resistivity, and density. Calibration is only available for specific conductance, conductivity, and salinity. Calibrating one of these options automatically calibrates the other conductivity/temperature parameters listed above. For both ease of use and accuracy, YSI recommends calibrating specific conductance.

Select the appropriate calibration standard for the conductivity of the sampling environment. Standards at least 1 mS/cm (1000  $\mu\text{S}/\text{cm}$ ) are recommended for the greatest stability. For fresh water applications, calibrate to 1,000. For salt water applications, calibrate to 50,000  $\mu\text{S}$ .



**Figure 48** Calibrate specific conductance



**Figure 49** ODO/CT Cable Assembly

### Conductivity Calibration

1. Make sure the conductivity sensor is clean prior to calibration. If necessary, clean the conductivity cell with the supplied soft brush.
2. Place the correct amount of conductivity standard into a clean and dry or pre-rinsed calibration cup.
3. Carefully immerse the sensors into the solution. Make sure the solution is above the vent holes on the side of the conductivity sensor.

If using the ODO/CT assembly, ensure the vent holes at the top of the sensor are completely immersed and the solution level is at least 1 cm higher than the top vent holes (Figure 49). A graduated cylinder is included with ODO/CT cable assemblies for the purpose of calibrating conductivity.

For 4-port cable assemblies, fill the calibration cup to the second line with fresh calibration standard. It takes 225 mL of solution to fill to line 2.

4. Gently rotate and/or move the sensor up and down to remove any bubbles from the conductivity cell. Allow at least 40 seconds for temperature equilibration before proceeding.
5. Push the  $\text{Cal}$  key, select **Conductivity**, then select **Specific Conductance**.
6. Select **Calibration value** then enter the calibration value of the standard used. Note the measurement units the instrument is reporting and calibrating and be sure to enter in the correct calibration value for the units being used. For example, 10,000  $\mu\text{S}$  = 10 mS. Make sure that the units are correct and match the units displayed on the handheld.
7. Observe the actual measurement readings for stability (white line on graph shows no significant change for 40 seconds), then select **Accept Calibration** (Figure 48). "Calibration successful!" will be displayed in the message area.

(continued on next page)

## Conductivity Calibration (continued)

8. Rinse the sensor in clean water then dry.

**NOTE:** If the data is not stabilized after 40 seconds, gently rotate the sensor or remove/reinstall the calibration cup to make sure that no air bubbles are in the conductivity cell.

If you get calibration error messages, check for proper sensor immersion, verify the calibration solutions is fresh, the correct value has been entered into the handheld, and/or try cleaning the sensor.

## 3.4 Barometer

The barometer is factory calibrated and should rarely need to be recalibrated. The barometer is used for DO calibration, %Local measurements, and for virtual vented depth measurements. Verify that the barometer is accurately reading “true” barometric pressure and recalibrate as necessary.

Laboratory barometer readings are usually “true” (uncorrected) values of air pressure and can be used “as is” for barometer calibration. Weather service readings are usually not “true”, i.e. they are corrected to sea level and cannot be used until they are “uncorrected”. Use this approximate formula:

$$\text{True BP in mmHg} = [\text{Corrected BP in mmHg}] - [2.5 * (\text{Local altitude in ft. above sea level} / 100)]$$

Example:

$$\text{Corrected BP} = 759 \text{ mmHg}$$

$$\text{Local altitude above sea level} = 978 \text{ ft}$$

$$\text{True BP} = 759 \text{ mmHg} - [2.5 * (978 \text{ ft} / 100)] = 734.55 \text{ mmHg}$$

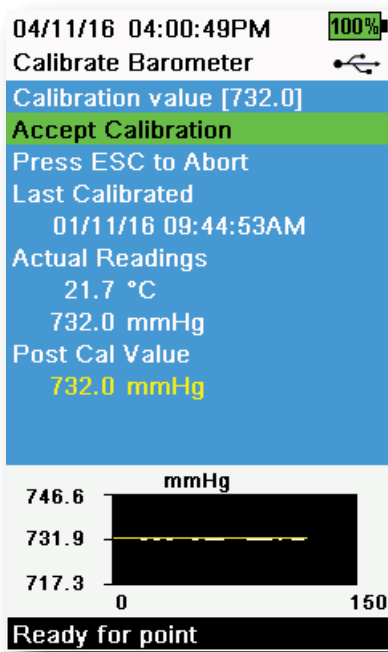


Figure 50 Calibrate Barometer

### Barometer Calibration

1. Push the **Cal** key, then select **Barometer**.
2. Select **Calibration value** then enter the correct “true” barometric pressure.

**NOTE:** The measurement units during calibration are dictated by what is enabled in the sensor setup menu. Be sure to enter in the correct units.

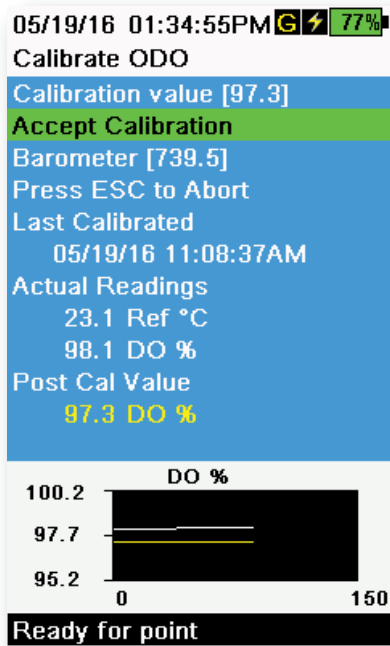
- BP in mmHg = 25.4 x BP inHg
- BP in mmHg = 0.750062 x BP mb
- BP in mmHg = 51.7149 x BP psi
- BP in mmHg = 7.50062 x BP kPa
- BP in mmHg = 760 x BP atm

3. Select **Accept Calibration** (Figure 50). “Calibration successful!” will be displayed in the message area.

## 3.5 Dissolved Oxygen


ODO calibration requires the current “true” barometric pressure. Make sure that the barometer is reading accurately prior to ODO calibration.

Calibrating in DO% or DO% local automatically calibrates the mg/L and ppm measurement. There is no reason to calibrate both parameters. For both ease of use and accuracy, we recommend that you calibrate DO% or DO% Local and not mg/L.



**Figure 51** Calibrate ODO %

### ODO% and ODO% Local - Water Saturated Air Calibration

1. Place a small amount of clean water (5 mL) in the calibration cup or a wet sponge into the calibration sleeve (for ODO/T and ODO/CT probes).
2. Make sure there are no water droplets on the ODO sensor cap or temperature sensor.
3. Attach the probe guard and carefully slide into the calibration cup. Make sure a seal is not created around the probe. Atmospheric venting is required for accurate calibration.
4. Turn the instrument on and wait approximately 5 to 15 minutes for the air in the storage container to be completely saturated with water.
5. Push the  key, then select **ODO**. Select **DO%**.
6. Observe the actual measurement readings for stability (white line on graph shows no significant change for 40 seconds), then select **Accept Calibration** (Figure 51). “Calibration successful!” will be displayed in the message area.

**NOTE:** If you see a calibration error message, verify the barometer reading and inspect the sensor cap. Clean and/or replace the sensor cap as needed.

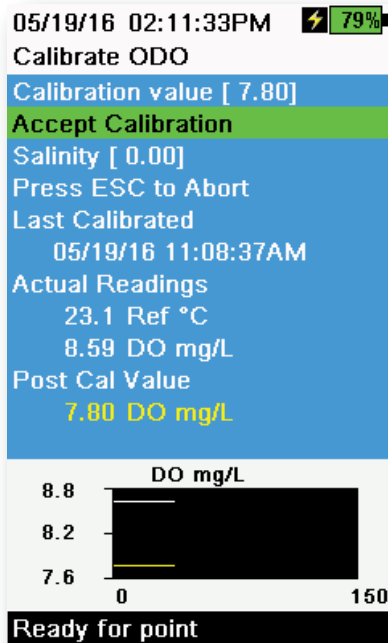


Figure 52 Calibrate ODO mg/L

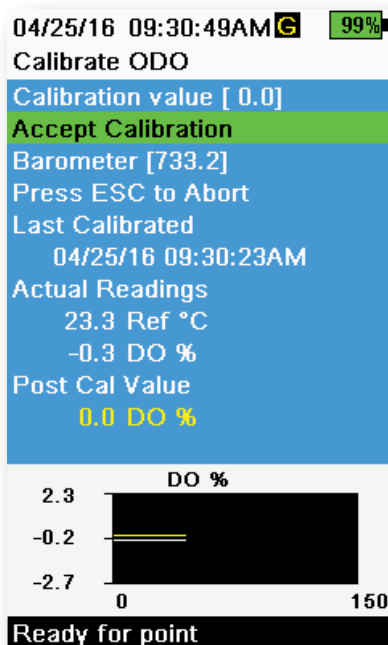



Figure 53 Calibrate ODO zero point


## ODO mg/L Calibration

1. Place the ODO and conductivity/temperature sensor into a water sample that has been titrated by the Winkler method to determine the dissolved oxygen concentration in mg/L.
2. Push the  key, then select **ODO**. Select **DO mg/L**.
3. Select **Calibration value**.
4. Enter the dissolved oxygen concentration of the sample in mg/L.
5. Observe the actual measurement readings for stability (white line on graph shows no significant change for 40 seconds), then select **Accept Calibration** (Figure 52). "Calibration successful!" will be displayed in the message area.
6. Rinse the bulkhead and sensors in clean water then dry.

## ODO Zero Point Calibration

1. Place the ODO and Conductivity/Temperature sensors in a solution of zero DO.

**NOTE:** A zero DO solution can be made by dissolving approximately 8-10 grams of sodium sulfite into 500 mL of tap water. Mix the solution thoroughly. It may take the solution 60 minutes to be oxygen-free.

2. Push the  key, then select **ODO**. Select **Zero**.
3. Observe the actual measurement readings for stability (white line on graph shows no significant change for 40 seconds), then select **Accept Calibration** (Figure 53). "Calibration successful!" will be displayed in the message area.
4. Thoroughly rinse the bulkhead and sensors in clean water then dry.
5. Perform a ODO % water-saturated air calibration after performing a zero point calibration.

# 3.6

## Turbidity

### Standards

For best results, YSI recommends the following standards for turbidity calibration:

Calibration Point	Standard Value
1	0 FNU [SKU: 608000]
2	12.4 FNU [SKU: 607200] or 124 FNU [SKU: 607300]
3	1010 FNU [SKU: 607400]

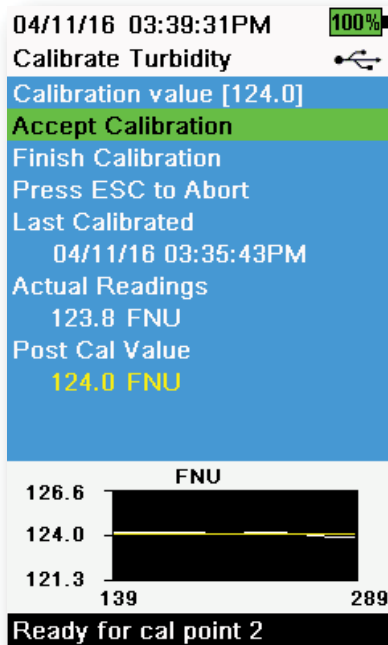
Other standards may be acceptable as long as they have been prepared according to details in Standard Methods for the Treatment of Water and Wastewater (Section 2130 B). These standards include:

- YSI Certified AMCO-AEPA polymer-based standards (see above)
- Hach StabCal™ standards in various NTU denominations
- Dilutions of 4000 NTU formazin concentrate purchased from Hach
- Other formazin standards prepared according to the Standard Methods

The use of standards other than those mentioned above will result in calibration errors and inaccurate field readings. It is important to use the same type of standard for all calibration points; do not mix formazin and polymer-based standards for different points in a multi-point calibration.

When using an alternative standard (non-YSI), calibration can be completed using the following limits:

	Min	Max	Unit
1st Calibration Point	0.0	1.0	FNU or NTU
2nd Calibration Point	5.0	200	FNU or NTU
3rd Calibration Point	400	4000	FNU or NTU



**Figure 54** Calibrate Turbidity

## Turbidity Calibration 2-Point

Turbidity calibrations, more than most other parameters, are susceptible to interference from contamination. It is critical for calibrations to be performed with very clean sensors, guards, and cups.

**NOTE:** Calibration standards should not be re-used.

1. Fill the calibration cup to the appropriate level with 0 FNU standard (deionized water may be used as a substitute). The sensor guard must be installed to ensure an accurate calibration. Make sure the guard is installed and immerse the probe in the zero standard.
2. Push the **Cal** key, then select **Turbidity**.
3. Select **Calibration Value** and enter 0.00.
4. Make sure there are no air bubbles on the turbidity sensor lens. If present, lightly tap the guard against the cup to dislodge any bubbles. Observe the actual measurement readings for stability (white line on graph shows no significant change for 40 seconds), and then select **Accept Calibration**. "Ready for cal point 2" will be displayed in the message area.
5. Discard the used standard, and rinse the probe, guard, and calibration cup with a small amount of the next calibration point standard. Discard the rinse standard.
6. Fill the calibration cup to the appropriate level with fresh standard for the second calibration point. Immerse the probe in the standard.
7. Select **Calibration Value** and enter the value of the second calibration standard.
8. Make sure there are no air bubbles on the turbidity sensor lens. Observe the actual measurement readings for stability, and then select **Accept Calibration** (Figure 54). "Ready for cal point 3" will be displayed in the message area.
9. Select **Finish Calibration** to complete a 2-point calibration or continue for the 3-point calibration.

Repeat steps 5 through 8 for a 3-point calibration. "Calibration successful!" will be displayed in the message area. After calibration, rinse with water and dry the probe.

## 3.7

# Total Algae

## TAL Sensors

YSI offers two Total Algae (TAL) sensor options. Both are dual-channel fluorescence sensors.

The channels on the TAL-PC sensor refer to two independent data sets: one results from a blue excitation beam that excites the chlorophyll a (Chl) molecule and the second results from an orange excitation beam that excites the phycocyanin (PC) accessory pigment. TAL-PC sensors are typically selected for monitoring freshwater cyanobacteria.

The TAL-PE sensor is similar in having a chlorophyll channel, but utilizes a slightly blueshifted beam that excites the pigment phycoerythrin (PE). TAL-PE sensors are typically selected for monitoring marine cyanobacteria.

## TAL Units

The TAL sensors report data in RFU and  $\mu\text{g/L}$  of pigment (Chl, PC or PE) units. YSI recommends reporting in Relative Fluorescence Units (RFU).

RFU is used to set sensor output relative to a stable secondary standard, Rhodamine WT dye. This allows users to calibrate sensors identically so that results from sensor to sensor can be compared. Calibration with Rhodamine WT also enables users to monitor for sensor drift and external factors such as biofouling or declining sensor optical performance over time as the LEDs age.

The excellent linearity of RFU, once the channels are calibrated with Rhodamine WT, translates to the best accuracy of measurements. For example, a chlorophyll reading of 100 units will represent twice the pigment detected by the sensor than with a chlorophyll reading of 50 units. This high linearity ( $R^2 > 0.9999$ ) doesn't always hold for  $\mu\text{g/L}$  of pigment since that unit was derived from laboratory monocultures, and an environmental algal population can behave quite differently. This is also why the TAL sensors and in situ monitoring should not be regarded as a perfect replacement for other methods such as pigment extractions and cell counting.

The  $\mu\text{g/L}$  output generates an estimate of pigment concentration that is based upon correlations built with sensor outputs and extractions of pigments from laboratory-grown blue-green algae. Synonymous with parts per billion (ppb),  $\mu\text{g/L}$  is still commonly used by regulatory agencies, but has the drawback that it is very dependent upon the composition of the algal population, the time of day, the physiological health of the algae, and a number of other environmental factors. Thus, users are advised to do their own check of our correlation with a population of algae relevant to their own sites, as described below.

A 2-point RFU calibration is advised to be performed first. Next, with samples collected from the site of interest, measure both RFU and  $\mu\text{g/L}$  with the sensor(s). Observing careful handling and preservation of the samples, as soon as possible extract the pigments from the samples, using standardized methods to determine the  $\mu\text{g/L}$  in each sample. The extraction data may be used to assess how RFU and  $\mu\text{g/L}$  delivered by the sensor compare with the  $\mu\text{g/L}$  of pigment that would be predicted by RFU from the sensor. The user's requirements can guide the decision as to whether RFU or  $\mu\text{g/L}$  is the best unit to read from the sensor for any specific application.

TAL Raw values can only be seen under [Sensor info](#) in the System menu and are unaffected by user calibrations. These values range from 0-100, representing the percent of full scale that the sensor detects in a sample, and are used for diagnostic purposes.



## Rhodamine WT Dye Solution Preparation

Rhodamine WT dye solution must be used when completing a 2-point calibration. Purchase Rhodamine WT as a 2.5% solution to follow the procedure below. Kingscote Chemicals (Miamisburg, OH, 1-800-394-0678) has historically had a 2.5% solution (item #106023) that works well with this procedure. Note that there are many types of Rhodamine—make sure Rhodamine **WT** is selected. If a 2.5% solution cannot be obtained commercially, prepare it from a solid or from another concentration of a liquid solution to a 2.5% final concentration, or adjust the dilutions below accordingly. It should be stored in the refrigerator when not in use.

For PC and chlorophyll channel calibrations, a 0.625 mg/L solution of Rhodamine WT should be prepared. For PE channel calibration, a 0.025 mg/L solution of Rhodamine WT should be prepared. The steps below describe one procedure to prepare these solutions.

1. *For any TAL sensor calibration, prepare a 125 mg/L solution of Rhodamine WT.* Transfer 5.0 mL of the 2.5% Rhodamine WT solution into a 1000 mL volumetric flask. Fill the flask to the volumetric mark with deionized or distilled water and mix well to produce a solution that is approximately 125 mg/L of Rhodamine WT. Transfer to a storage bottle and retain it for future use.  
  
\*This solution can be stored in the refrigerator (4°C). Its degradation will depend upon light exposure and repeated warming cycles, but solutions used 1-2 times a year can be stored for up to two years. Users should implement their own procedures to safeguard against degradation.
2. *For PC and chlorophyll channel calibrations, prepare a 0.625 mg/L solution of Rhodamine WT.* Transfer 5.0 mL of the 125 mg/L solution prepared in step one into a 1000 mL volumetric flask. Fill the flask to the volumetric mark with deionized or distilled water. Mix well to obtain a solution that is 0.625 mg/L of Rhodamine WT. Use this solution within 24 hours of preparation and discard it after use.
3. *For PE channel calibration, prepare a 0.025 mg/L solution of Rhodamine WT.* Transfer 0.2 mL of the 125 mg/L solution prepared in step one into a 1000 mL volumetric flask. Fill the flask to the volumetric mark with deionized or distilled water. Mix well to obtain a solution that is 0.025 mg/L of Rhodamine WT. Use this solution within 24 hours of preparation and discard it after use.

In addition to preparing the Rhodamine solution(s), it is also necessary to determine temperature-compensated calibration values for solutions. In general, fluorescence is inversely related with temperature. Measure the temperature of the Rhodamine solution(s) and use the temperature of the solution at the time of calibration to select the compensated solution concentrations, in either RFU (recommended) or µg/L pigment equivalents, from the table below.

As an example, assume that you will calibrate the chlorophyll channel in RFU, and that the temperature measured in the 0.625 mg/L Rhodamine WT solution is 22°C. The first standard value entered will be 0, and the second standard value will be 16.4 (see table on page 41). Likewise, if you intend to use the default µg/L unit when calibrating chlorophyll, the second standard value would be 66 in this example. Using the same 0.625 mg/L Rhodamine WT solution to calibrate the PC channel will yield a second standard value of 16.0 RFU or 16 µg/L. These values will be entered when performing a 2-point calibration.

## Rhodamine WT Dye Solution Preparation (continued)

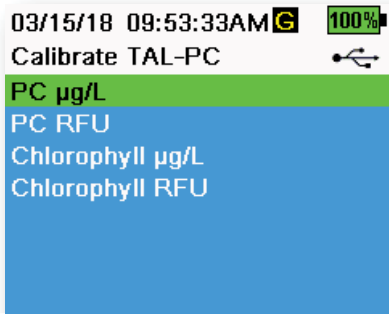
Temp (°C)	Chlorophyll		Phycocyanin		Phycoerythrin	
	RFU	µg/L	RFU	µg/L	RFU	µg/L
30	14.0	56.5	11.4	11.4	37.3	104.0
28	14.6	58.7	13.1	13.1	39.1	109.0
26	15.2	61.3	14.1	14.1	41.0	115.0
24	15.8	63.5	15.0	15.0	43.0	120.0
22	16.4	66	16.0	16.0	45.0	126.0
20	17.0	68.4	17.1	17.1	47.0	132.0
18	17.6	70.8	17.5	17.5	49.2	138.0
16	18.3	73.5	19.1	19.1	51.4	144.0
14	18.9	76	20.1	20.1	53.6	150.0
12	19.5	78.6	21.2	21.2	55.9	157.0
10	20.2	81.2	22.2	22.2	58.2	163.0
8	20.8	83.8	22.6	22.6	60.6	170.0

## TAL Calibration

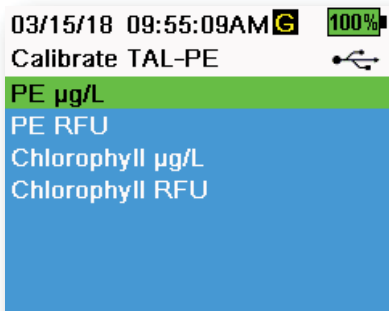
A 1- or 2-point calibration can be completed for all channels on the TAL-PC and TAL-PE sensors.

A 1-point calibration, typically completed in clear deionized or distilled water, is simply a re-zeroing of the sensor. This calibration does not reset the second point entered during the previous 2-point calibration. The consequence is that error will be alleviated at and near zero, but more error can accumulate in the measurement the farther away from zero the measured value is. The amount of error is dependent upon how much the second point drifts, which is not always equivalent to how much the zero point drifts.

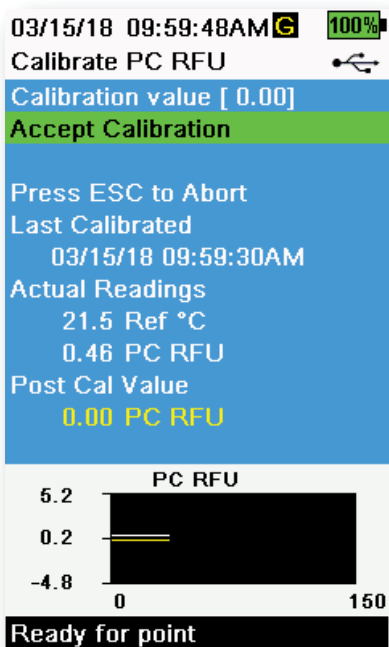
For many users, especially those with sites where pigment is rarely detected and values are at or near zero most of the time, the far-from-zero accumulation of error is a non-issue. For others, it is best to perform a 2-point calibration using a Rhodamine WT solution.



**Figure 55** TAL-PC Calibration Options



**Figure 56** TAL-PE Calibration Options



**Figure 57** Calibrate PC RFU

## PE, PC and Chlorophyll Calibration 2-Point

Each channel of the sensor must be calibrated independently. Calibration of the chlorophyll channel does not set the calibration for the PC channel or the PE channel. In addition, calibrating in RFU for a channel does not automatically calibrate the  $\mu\text{g/L}$  measurement for the same channel. The following calibration procedure must be performed for each channel and each unit the user would like to display.

1. Fill the calibration cup to the appropriate level with deionized water (0 standard). Immerse the probe in the standard. Make sure the sensor guard is installed.
2. Push the  $\text{Cal}$  key, then select either **TAL-PC** or **TAL-PE**, depending on the sensor to be calibrated.
3. Select the channel and units to be calibrated. Options for the TAL-PC sensor are shown in Figure 55, while options for the TAL-PE sensor are shown in Figure 56.
4. Select **Calibration Value** and enter 0.00.
5. Make sure there are no air bubbles on the sensor lens. If present, lightly tap the guard against the cup to dislodge any bubbles. Observe the actual measurement readings for stability (white line on graph shows no significant change for 40 seconds), and then select **Accept Calibration**. "Ready for cal point 2" will be displayed in the message area.
6. Discard the used water, and rinse the probe, guard, and calibration cup with a small amount of the standard for calibration point #2. Discard the rinse standard.

**NOTE:** For standard #2, use the 0.625 mg/L Rhodamine WT solution when calibrating chlorophyll (RFU or  $\mu\text{g/L}$ ) on either TAL sensor, or when completing a PC (RFU or  $\mu\text{g/L}$ ) calibration on a TAL-PC sensor. Use the 0.025 mg/L Rhodamine WT solution when completing a PE (RFU or  $\mu\text{g/L}$ ) calibration on a TAL-PE sensor.

7. Fill the calibration cup to the appropriate level with fresh standard #2. Immerse the sensors in the second calibration standard.
8. Observe the temperature reading on the calibration display (Figure 57). Use the table in the [Rhodamine WT dye solution preparation section](#) to identify the appropriate value for the calibration standard.
9. Select **Calibration Value** and enter the value of the second calibration standard.
10. Observe the actual measurement readings for stability (white line on graph shows no significant change for 40 seconds), then select **Accept Calibration**. The procedure will automatically finish after calibrating using the second standard.

# 3.8

## pH/ORP

Observe the pH mV readings during calibration to understand the condition and response of the pH sensor. In buffer 7, pH mVs should be between -50 and +50. In pH4 buffer, the mV reading should be 165 to 185 mV higher than the reading in pH 7 buffer. In pH 10 buffer, the mV reading should be 165 to 185 mV lower than the reading in pH 7 buffer. The theoretically ideal slope is -59 mV/pH unit.

### 1-Point

While a 1-point pH calibration is possible, this calibration procedure adjusts only the pH offset and leaves the previously determined slope unaltered. This should only be performed if you are adjusting a previous 2-point or 3-point calibration.

### 2-point

Perform a 2-point pH calibration if the pH of the media to be monitored is known to be either basic or acidic. In this procedure, the pH sensor is calibrated with a pH 7 buffer and a pH 10 or pH 4 buffer depending upon the pH range you anticipate for your water to be sampled.

### 3-point

Perform a 3-point pH calibration to assure maximum accuracy when the pH of the environmental water cannot be anticipated or fluctuates above and below pH 7. In this procedure, the pH sensor is calibrated with pH 7, pH 10, and pH 4 buffer solutions.

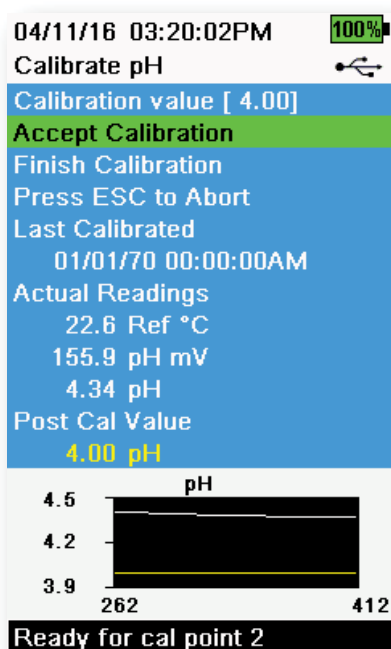



Figure 58 Calibrate pH 2- or 3-point

## pH Calibration 3-Point

1. Always start the calibration with pH 7 buffer. Fill the calibration cup to the appropriate level with pH 7 buffer solution.
2. With the probe guard installed, carefully immerse the probe into the buffer solution. Make sure both the pH sensor and temperature sensor are submerged.
3. Push the **Cal** key; then select **pH** or **pH/ORP**.
4. The **Calibration value** will automatically be adjusted based on the selected buffer and temperature. Alternatively, the Calibration value can be manually entered..
5. Wait for the pH mV and temperature readings to stabilize; the white line on the graph should be flat for about 40 seconds.
6. Select **Accept Calibration** and press the **ENTER** key. "Ready for cal point 2" will be displayed in the message area.
7. Rinse the probe and calibration cup. Fill to the appropriate level with either pH 10 or pH 4 buffer solution; it doesn't matter which one comes next.
8. Immerse the probe into the buffer solution. The **Calibration value** will automatically be adjusted based on the selected buffer and temperature.
9. Wait for the pH mV and temperature readings to stabilize; the white line on the graph should be flat for about 40 seconds.
10. Select **Accept Calibration** and press the **ENTER** key. "Ready for cal point 3" will be displayed in the message area.



## pH Calibration 3-Point (continued)

**NOTE:** For 2-Point calibrations, select Accept Calibration before selecting Finish Calibration.

11. Rinse the probe and calibration cup. Fill to the appropriate level with the final buffer solution.
12. Immerse the probe into the buffer solution. The **Calibration value** will automatically be adjusted based on the selected buffer and temperature.
13. Wait for the pH mV and temperature readings to stabilize; the white line on the graph should be flat for about 40 seconds.
14. Select **Accept Calibration** and press the  key. The procedure will automatically finish after calibrating the third point.



## ORP Calibration

1. Obtain a premixed standard solution that is approved for use with Ag/AgCl ORP sensors or prepare a standard with a known oxidation reduction potential (ORP) value. Zobell solution is recommended.
2. With the probe guard installed, carefully immerse the probe into the standard solution. Make sure both the ORP sensor and temperature sensor are submerged.
3. Push the  key, then select **pH/ORP**, then **ORP**.
4. If using YSI Zobell solution, the **Calibration value** will automatically be adjusted based on the temperature. Otherwise, refer to the table included with the standard solution and enter the mV value that corresponds to the temperature of the solution.
5. Wait for the ORP mV and temperature readings to stabilize; the white line on the graph should be flat for about 40 seconds.
6. Select **Accept Calibration** and press the  key. "Calibration successful!" will be displayed in the message area.

**Figure 59** Calibrate ORP

# 3.9

## ISEs

### Ammonium, Nitrate, & Chloride

YSI recommends a 2-point calibration for ISEs. For best results, use standards that differ by 2 orders of magnitude:

- 1 mg/L and 100 mg/L for Ammonium and Nitrate
- 10 mg/L and 1,000 mg/L for Chloride

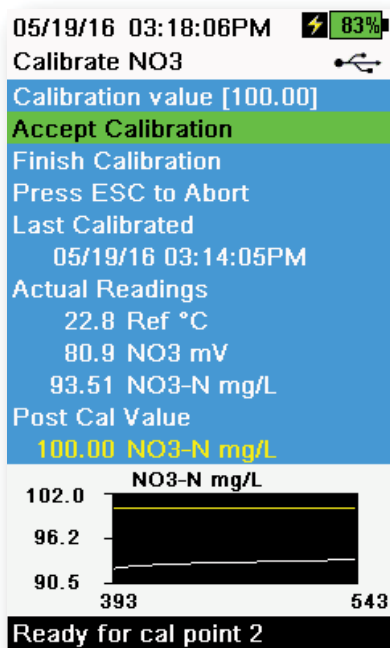


Figure 60 Calibrate ISE

### ISE Calibration

1. Fill the calibration cup to the appropriate level standard for calibration point #1. Immerse the probe in the standard.
2. Push the **Cal** key, then select the applicable ISE sensor.
3. Select **Calibration value** and enter the value that corresponds to the first calibration standard.
4. Observe the actual measurement readings for stability (white line on graph shows no significant change for 40 seconds), then select **Accept Calibration**. "Ready for cal point 2" will be displayed in the message area.
5. Discard the used standard and rinse the probe and calibration cup with a small amount of the next calibration point standard. Discard the rinse standard.
6. Fill the calibration cup to the appropriate level with fresh standard for the second calibration point. Immerse the probe in the standard.
7. Select **Calibration value** and enter the value of the second calibration standard.
8. Observe the actual measurement readings for stability, and then select **Accept Calibration** (Figure 60). "Ready for cal point 3" will be displayed in the message area.
9. Select **Finish Calibration** to complete a 2-point calibration.

### Optimal mV for ISE calibration

#### Ammonium mV values

- $\text{NH}_4$  1 mg/L = 0 mV +/- 20 mV (new sensor only)
- $\text{NH}_4$  100 mg/L = 90 to 130 mV greater than the mV reading in the 1 mg/L standard
- The mV span between 1 mg/L and 100 mg/L values should be approximately 90 to 130 mV. The slope should be 45 to 65 mV per decade of ammonium concentration in mg/L

#### Nitrate mV values

- $\text{NO}_3$  1 mg/L = 200 mV +/- 20 mV (new sensor only)
- $\text{NO}_3$  100 mg/L = 90 to 130 mV less than the mV reading in the 1 mg/L mV standard
- The mV span between 1 mg/L and 100 mg/L values should be approximately 90 to 130 mV. The slope should be -45 to -65 mV per decade of nitrate concentration in mg/L

#### Chloride mV values

- Cl 10 mg/L = 225 mV +/- 20 mV (new sensor only)
- Cl 1,000 mg/L = 80 to 130 mV < 10 mg/L mV value
- The mV span between 10 mg/L and 1000 mg/L values should be approximately 80 to 130 mV. The slope should be -40 to -65 mV per decade of chloride concentration in mg/L


## Chilled Third Calibration Point

The chilled 3-point calibration is recommended if there is a large temperature variation during sampling or when the temperature of the media cannot be anticipated. The highest concentration solution and one of the lower concentration solutions should be at ambient temperature. The other lower concentration solution should be chilled to less than 10°C to prior calibration point.

1. Discard the used standard and rinse the probe and calibration cup with a small amount of the next calibration point standard. Discard the rinse standard.
2. Fill the calibration cup to the appropriate level with fresh standard for the third calibration point. Immerse the probe in the standard.
3. Select **Calibration value** and enter the value of the third calibration standard.
4. Observe the actual measurement readings for stability, and then select **Accept Calibration**. "Calibration successful!" will be displayed in the message area.

## Preparing Standards


We recommend using YSI calibration solutions whenever possible. However, qualified users can follow these recipes to prepare their own standards.

 **CAUTION:** Some of the chemicals required for these solutions could be hazardous under some conditions; therefore, the standards should only be prepared by qualified chemists in laboratories where proper safety precautions are possible. It is the responsibility of the user to obtain and study the MSDS for each chemical and to follow the required instructions with regard to handling and disposal of these chemicals.

## Ammonium Standards

You will need:

- Solid ammonium chloride or a certified 100 mg/L  $\text{NH}_4^+\text{-N}$  from a supplier
- Lithium acetate dihydrate
- Concentrated hydrochloric acid
- High purity water
- A good quality analytical balance
- A 1000 mL volumetric flask
- Accurate volumetric measuring devices for 100 mL and 10 mL of solution
- And a 1000 mL glass or plastic storage vessels

 **CAUTION:** Hydrochloric acid is highly corrosive and toxic and should therefore be handled with extreme care in a well-ventilated fume hood. The equivalent amount of a less-hazardous, more dilute sample of the acid may be used if preferred.

### 100 mg/L Standard

1. Accurately weigh 0.3817 g of ammonium chloride and transfer quantitatively into a 1000 mL volumetric flask. Add 2.6 g of lithium acetate dihydrate to the flask.
2. Add approximately 500 mL of distilled or deionized water to the flask. Swirl to dissolve all of the reagents and then dilute to the volumetric mark with distilled or deionized water.
3. Mix well by repeated inversion and then transfer the 100 mg/L standard to a storage bottle.
4. Add 3 drops of concentrated hydrochloric acid to the bottle, then seal and agitate to assure homogeneity. Alternatively, 100 mL of certified 100 mg/L  $\text{NH}_4^+\text{-N}$  standard can be used in place of the solid ammonium chloride.

## Ammonium Standards (continued)

### 1 mg/L Standard

1. Accurately measure 10.0 mL of the above 100 mg/L standard solution into a 1000 mL volumetric flask. Add 2.6 g of lithium acetate dihydrate to the flask.
2. Add approximately 500 mL of distilled or deionized water. Swirl to dissolve the solid reagents and then dilute to the volumetric mark with water.
3. Mix well by repeated inversion and then transfer the 1 mg/L standard to a storage bottle.
4. Add 3 drops of concentrated hydrochloric acid to the bottle, then seal and agitate to assure homogeneity.

Other concentrations can be made by altering the amount of ammonium chloride. All other ingredient concentrations should remain unchanged.

## Nitrate Standards

You will need:

- Solid potassium nitrate or a certified 1000 mg/l  $\text{NO}_3\text{-N}$  from a supplier
- Magnesium sulfate, high purity water
- A good quality analytical balance
- 1000 mL volumetric flask
- Accurate volumetric measuring devices for 100 mL, 10 mL and 1 mL of solution
- And 1000 mL glass or plastic storage vessels

### 100 mg/L standard

1. Accurately weigh 0.7222 g of anhydrous potassium nitrate and transfer quantitatively into a 1000 mL volumetric flask. Add 1.0 g of anhydrous magnesium sulfate to the flask.
2. Add approximately 500 mL of water to the flask. Swirl to dissolve all of the reagents, and then dilute to the volumetric mark with distilled or deionized water.
3. Mix well by repeated inversion and then transfer the 100 mg/L standard to a storage bottle.
4. Rinse the flask extensively with water prior to its use in the preparation of the 1 mg/l standard. Alternatively, 100 mL of certified 1000 mg/L  $\text{NO}_3\text{-N}$  standard can be used in place of the solid potassium nitrate.

### 1 mg/L standard

1. Accurately measure 10.0 mL of the above 100 mg/L standard solution into a 1000 mL volumetric flask. Add 1.0 g of anhydrous magnesium sulfate to the flask.
2. Add approximately 500 mL of distilled or deionized water. Swirl to dissolve the solid reagents, and then dilute to the volumetric mark with water.
3. Mix well by repeated inversion and then transfer the 1 mg/L standard to a storage bottle.

Other concentrations can be made by altering the amount of potassium nitrate. All other ingredient concentrations should remain unchanged.



# Chloride Standards

You will need:

- Solid sodium chloride or a certified 1000 mg/L chloride solution from a supplier
- Magnesium sulfate
- High-purity water
- A good quality analytical balance
- 1000 mL volumetric flask
- An accurate 10 mL measuring devices
- And 1000 mL glass or plastic storage vessels

## 1000 mg/L Standard

1. Accurately weigh 1.655 grams of anhydrous sodium chloride and transfer into a 1000 mL volumetric flask.
2. Add 0.5 grams of anhydrous magnesium sulfate to the flask.
3. Add 500 mL of water to the flask, swirl to dissolve all of the reagents, then dilute to the volumetric mark with water.
4. Mix well by repeated inversion, then transfer the 1000 mg/L standard to a storage bottle.
5. Rinse the flask extensively with water prior to its use in the preparation of the 10 mg/L standard. Alternatively, simply add 0.5 grams of magnesium sulfate to a liter of a 1000 mg/L chloride standard from a certified supplier.

## 10 mg/L Standard

1. Accurately measure 10 mL of the above 1000 mg/L standard solution into a 1000 mL volumetric flask.
2. Add 0.5 grams of anhydrous magnesium sulfate to the flask.
3. Add 500 mL of water, swirl to dissolve the solid reagents, then dilute to the volumetric mark with water.
4. Mix well by repeated inversion, then transfer the 10 mg/L standard to a storage bottle.

# 4. Maintenance and Storage

Follow all maintenance and storage procedures in this section. Incorrect or unapproved maintenance and/or storage can cause handheld, sensor or cable damage not covered by the warranty.

Storage terms are defined as follows:

## Short-term Storage = Less than 4 weeks

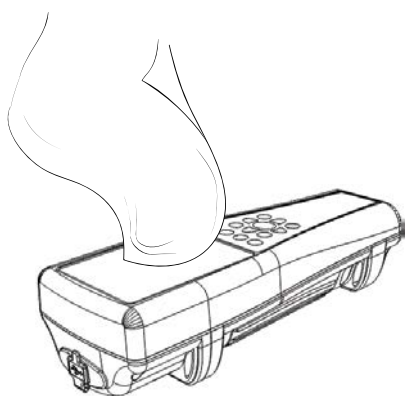
Short-term storage is appropriate when the handheld, cables, and sensors will be used at regular intervals (daily, weekly, etc.).

## Long-term Storage = More than 4 weeks

During long periods of inactivity, such as the “off-season” for environmental monitoring, the instrument, sensors, and cables should be placed in long-term storage.

YSI recommends cleaning and maintenance before long-term storage.

## 4.1 ProDIGITAL Handheld



**Figure 61** Handheld cleaning

Wipe the keypad, screen, and case with a cloth dampened with a mild solution of clean water and dish soap (Figure 61). Optimal storage temperature of the handheld instrument is 0-45°C. The battery pack permanently loses capacity at a faster rate when above 45°C.

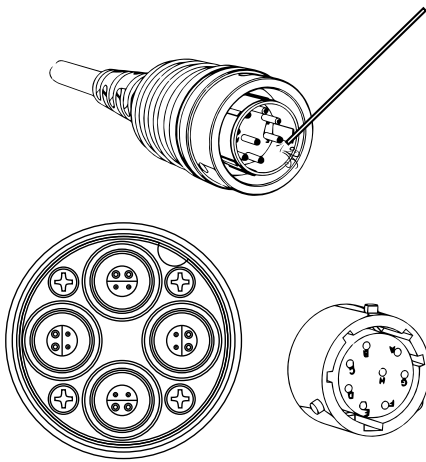
### Short-term Storage:

Assure that the handheld instrument is powered off, and store it in a temperature-controlled, secure location. Ideally all ports should be covered to prevent dust, water, or other contamination.

### Long-term Storage:

In addition to the short-term storage guidelines above, remove the battery pack to prevent any damage from possible battery leaks. Reinstall the battery cover. Store the battery pack in a dry place ideally around 25°C.

## 4.2 4-Port Bulkhead



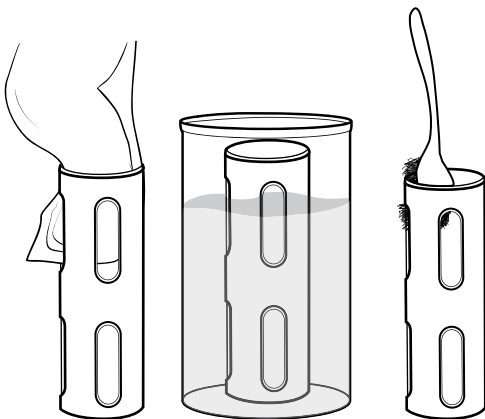
**Figure 62** Cable, bulkhead, connector maintenance

Wipe the cable and bulkhead with a cloth dampened with a mild solution of clean water and dish soap. Make sure sensors or port plugs are installed in ProDSS 4-port cable assemblies so the bulkhead ports do not get wet when cleaning. Exposure to water can cause damage or corrosion to the bulkhead connectors not covered by the warranty.

For short-term storage, YSI recommends leaving the sensors installed on the bulkhead. The ODO, pH, and pH/ORP sensors must be kept in a moist air environment; therefore, place a small amount of water (5-10 mL) in the calibration cup and tighten the retaining nut to seal the storage chamber.

For long-term storage, YSI recommends uninstalling the sensors from the bulkhead and following each sensor's respective long-term storage instructions. Inspect the bulkhead ports and cable connectors for contamination. If dirty or wet, clean it with compressed air (Figure 62). Install the cap that protected the bulkhead during initial shipment. Alternatively, install the bulkhead port plugs.

## 4.3 Sensor Guard



**Figure 63** Sensor guard maintenance

Remove light bio-fouling with a cloth soaked in a mild solution of clean water and dish soap. Soak in vinegar to remove hard growth and deposits. Use a plastic scrub brush to remove any remaining bio-fouling. Rinse the sensor guard with clean water (Figure 63).

**NOTICE:** Do not sand or polish the guard. Removal of the guard coating can affect some sensor readings.

## 4.4 Depth Sensor

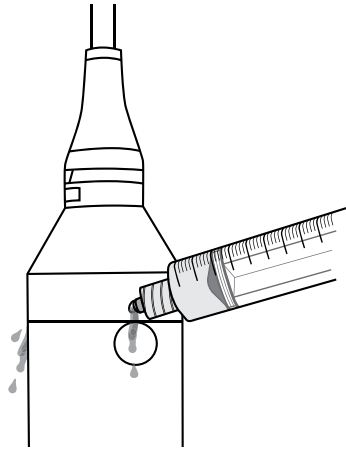


Figure 64 Depth sensor flush

The depth sensor on 4-port ProDSS cables should be flushed after each use. Fill the syringe (included with the maintenance kit) with clean water and gently push water through the ports located on the bulkhead. Flush until clean water flows from the opposite depth port (Figure 64).

The sensor can be stored wet or dry. For long-term storage, YSI recommends storing the sensor dry.

**NOTICE:** Do not insert objects into the depth ports. Damage to the depth transducer from incorrect cleaning is not covered by the warranty.

## 4.5 Temperature Sensor

To ensure optimal performance, it is important to keep the temperature sensor free of any deposits. Rinse the thermistor after each use. If deposits have formed, use mild soapy water and a soft bristle cleaning brush. The sensor can be stored wet or dry.

## 4.6 Conductivity Sensor

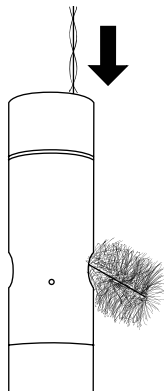


Figure 65 Channel brush

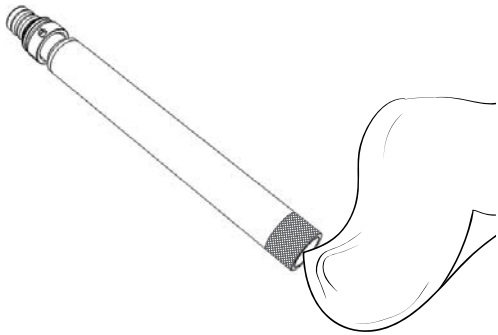
The conductivity channels should be cleaned after each use. Dip the sensor's cleaning brush (included with the maintenance kit) in clean water, insert the brush at the top of the channels, and sweep the channels 15 to 20 times (Figure 65).

If deposits have formed on the electrodes, use a mild solution of dish soap and water to brush the channels. For heavy deposits, soak the sensor in white vinegar, then scrub with the cleaning brush. Rinse the channels with clean water following the sweepings or soak.

The sensor can be stored wet or dry. For long-term storage, YSI recommends storing the sensor dry.

## 4.7

# Optical Dissolved Oxygen Sensor

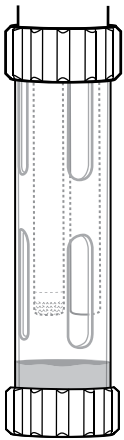


**Figure 66** ODO sensor window

The ODO sensor should be kept clean since some types of fouling may consume oxygen which could affect the dissolved oxygen measurements.

To clean the sensor cap, gently wipe away any fouling with a lens cleaning tissue that has been moistened with water to prevent scratches (Figure 66). Do not clean the ODO sensor with organic solvents as they may damage the cap.

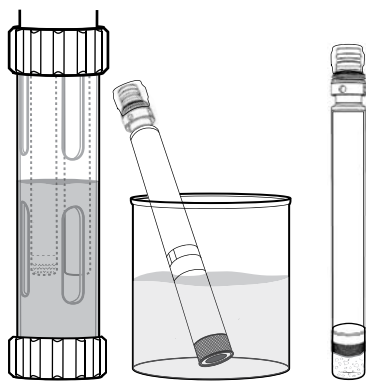
To minimize sensor drift, always store the ODO sensor in a wet or water-saturated air environment.



**Figure 67** ODO short-term storage

### Short-term Storage:

Store the ODO sensor in a moist air environment. A storage sleeve with a wet sponge or the calibration cup with a small amount of water is recommended (Figure 67).

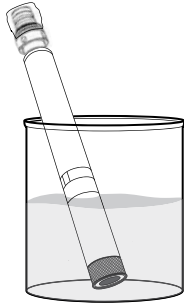


**Figure 68** ODO long-term storage

### Long-term Storage:

- **Method 1:** Submerge the sensing end of the sensor in a container of distilled or deionized water. Periodically check the level of the water to make sure that it does not evaporate.
- **Method 2:** Wet the sponge located in the cap originally included with the ODO sensor, then install on sensing end of the ODO sensor. Replace the sponge if it becomes dirty.

For ProDSS ODO sensors, the sensor can be left on the 4-port bulkhead or removed for long-term storage (Figure 68).



**Figure 69** ODO rehydration

## ODO Sensor Rehydration

If the ODO sensor has accidentally been left dry for longer than 8 hours, it must be rehydrated. To rehydrate, soak the ODO sensor in room temperature tap water for approximately 24 hours. After the soak, calibrate the sensor ([Figure 69](#)).

## ODO Sensor Cap

Optical DO sensor caps are warrantied for either 12 or 24 months depending on the model:

- ProDSS ODO Sensor Cap [SKU: 626890] = **12** months
- ODO Extended Warranty Sensor Cap [SKU: 627180] = **24** months

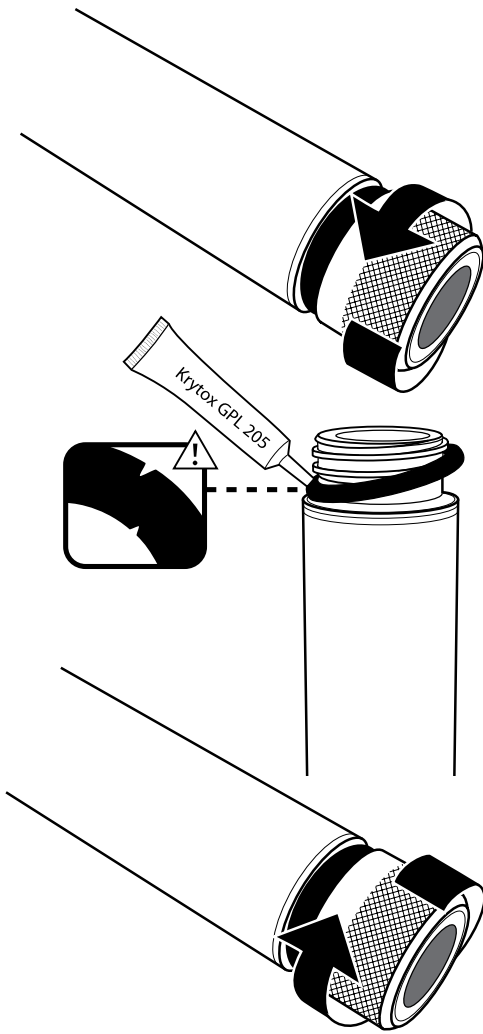
Depending on usage and storage practices, the cap may last longer than its warranty period.

As the ODO sensor caps ages, deterioration of the dye layer can reduce measurement stability and response time. Periodically inspect the sensor cap for damage and large scratches in the dye layer. Replace the cap when readings become unstable and cleaning the cap and DO recalibration do not remedy the symptoms.

## ODO Sensor Cap Replacement

The instruction sheet shipped with the replacement ODO sensor cap includes the calibration coefficients specific to that sensor cap. Make sure to save the ODO sensor cap instruction sheet in case you need to reload the calibration coefficients.

1. Remove the old sensor cap assembly from the probe by grasping the probe body with one hand and rotating the sensor cap counterclockwise until it is completely free. Do not use any tools for this procedure.
2. Carefully remove the o-ring by pinching it with your fingers and rolling it up. Do not use any tools to remove the o-ring. Clean the area of any debris with a lens cleaning tissue.
3. Install the new o-ring that is included with the replacement sensor cap.
4. Apply a thin coat of o-ring lubricant (included with the new cap) to the installed o-ring. Remove any excess o-ring lubricant with a lens cleaning tissue. Be careful to avoid contact with the sensor lens.
5. Inspect the sensor lens for any moisture or debris. If necessary, wipe the lens carefully with a non-abrasive, lint-free cloth to prevent scratches. Do not use organic solvents to clean the ODO sensor lens.
6. Remove the new sensor cap from its hydrated container and dry the inside cavity of the sensor cap with lens cleaning tissue. Make sure the cavity is completely dry before proceeding with the installation.
7. Using clockwise motion, thread the new sensor cap onto the probe assembly until it is finger-tight. The o-ring should be compressed between the sensor cap and probe. Do not over-tighten the sensor cap and do not use any tools for the installation process.
8. After installing the new sensor cap, store the sensor in either water or in the water-saturated air storage chamber.





**Figure 70** ODO cap replacement

**NOTE:** Be sure to update the ODO Sensor Cap Coefficients after replacement.

## Updating the ODO Sensor Cap Coefficients

After installing a new sensor cap, connect the probe to the handheld and turn the instrument on. Locate the Calibration Code Label on the ODO Sensor Cap Instruction Sheet. This contains the calibration codes for this particular sensor cap. Follow the procedures below to enter the new calibration coefficients into the instrument.

1. Push the  key to access the Sensor menu, then select **Setup**, then **ODO**.
2. Select **Sensor Cap Coefficients**.
3. Highlight each coefficient in turn (K1 through KC) and use the numeric entry screen to enter the corresponding new coefficient from the Calibration Code Label. Push the  key after each entry and then proceed to the next K selection.
4. After all the new coefficients have been entered, select **Update Sensor Cap Coefficients**.
5. A message will appear warning that you will be overwriting the current sensor cap coefficients and you should confirm that you wish to carry out this action. Select **Yes** to confirm the new coefficients.

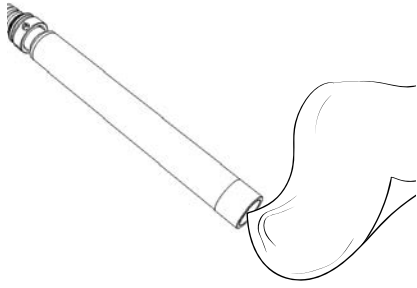
After updating the Coefficients, the Serial # in the Sensor Cap menu will be updated automatically based on your entries.

If errors are made in entering the Sensor Cap Coefficients, the instrument will block the update and an error message will appear on the display. If you see this error message, re-enter the coefficients and check them carefully.

**NOTE:** After entering the sensor cap coefficients, the ODO sensor must be calibrated.



## 4.8 Turbidity & Total Algae Sensors



**Figure 71** Sensor window

Clean the sensing window with a non-abrasive, lint-free cloth (Figure 71). If necessary, use mild soapy water.

The sensor can be stored wet or dry. For long-term storage, YSI recommends storing the sensor dry. Install the shipping cap or sensor guard to prevent scratches or damage to the optical sensing window.

## 4.9 pH/ORP Sensor

The pH and pH/ORP sensors are shipped with their tips in a storage bottle containing potassium chloride (KCl) solution. Keep this bottle for long-term storage.

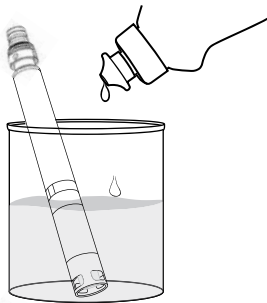
Periodic maintenance is necessary to clear contamination from the sensing elements. Contaminants on the bulb and/or junction can slow sensor response time. Clean the sensors when deposits, bio-fouling or other contamination appears on the glass or when the sensor response time is noticeably slow. There are several methods to clean and restore the sensor depending on the severity of fouling or contamination.

### Cleaning Methods

#### Standard Rinse

Rinse the sensor with tap water each time it is brought in from the field. This is generally recommended for most sensors and use cases to clear mild contamination.

If contaminants remain or the sensor exhibits a slow response time, continue with advanced cleaning.



**Figure 72** Cleaning the pH and pH/ORP sensor with dish soap

#### Advanced Cleaning

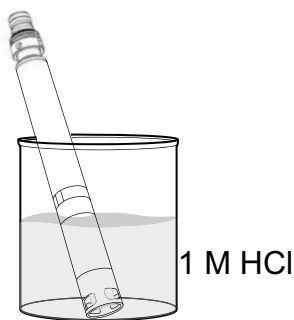
For moderate contamination or slow response after advanced rinsing, remove the sensor from the bulkhead and perform the following steps:

1. Remove any foreign matter from the sensor tip. If necessary, use a moistened cotton swab to carefully remove foreign material from the glass bulb and junction. Be careful to avoid direct contact with the glass bulb. The bulbs are fragile and will break if pressed with sufficient force.
2. Soak for 10 minutes in a mild solution of clean water and dish soap (Figure 72). Rinse the sensor with tap water and inspect.

If contaminants are removed, attach the sensor to the bulkhead and test the response time.

If contaminants remain or response time does not improve, continue to the hydrochloric acid (HCl) soak.

## pH/ORP Sensor Maintenance and Storage (continued)



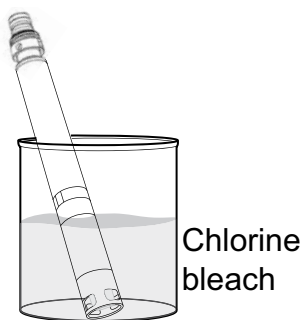
**Figure 73** Cleaning the pH and pH/ORP sensor with hydrochloric acid

### Acid Soak

For heavy contamination or slow response after advanced cleaning, remove the sensor from the bulkhead and perform the following steps:

1. Soak the sensor for 30 to 60 minutes in one molar (1 M) HCl (Figure 73). HCl reagent can be purchased from most chemical or laboratory distributors. To prevent injury, carefully follow the HCl manufacturer's instructions. If HCl is not available, soak in white vinegar.
2. After soaking, thoroughly rinse the sensor with tap water. Then soak the sensor in clean tap water for 60 minutes, stirring occasionally. Finally, rinse the sensor once again with tap water.

Attach the sensor to the bulkhead and test the response time. If response time does not improve or biological contamination of the reference junction is suspected, continue to the chlorine bleach soak.



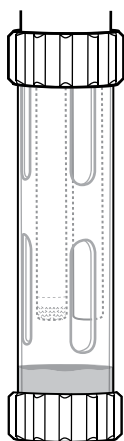
**Figure 74** Cleaning the pH and pH/ORP sensor with chlorine bleach

### Bleach Cleanse

If biological contamination of the reference junction is suspected or if good response is not restored by the previous methods, remove the sensor from the bulkhead and perform the following steps:

1. Soak the sensor for 60 minutes in a 1:1 dilution of chlorine bleach and tap water.
2. After soaking, thoroughly rinse the sensor with tap water. Then soak the sensor in clean tap water for 60 minutes. Finally, rinse the sensor once again with tap water.

Attach the sensor to the bulkhead and test the response time. If response time does not improve the sensor may be nearing the end of its useful life.

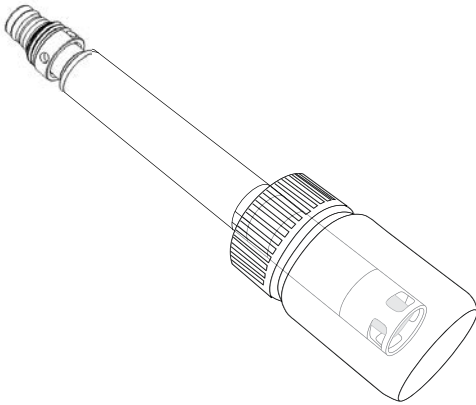


**Figure 75** pH and pH/ORP short-term storage

### Short-term Storage:

When in regular field use, the pH-pH/ORP sensors should remain on the bulkhead with the calibration/storage cup installed. Place a small amount of tap or surface water in the cup prior to storage or transport. The probes should be kept in this water-saturated air chamber between uses; not submerged (Figure 75). Make sure the storage cup makes a tight connection to prevent evaporation.

## pH/ORP Sensor Maintenance and Storage (continued)



**Figure 76** pH and pH/ORP  
long-term storage

### Long-term Storage:

Remove the sensor from the bulkhead and plug the bulkhead port. Insert the sensor tip into the storage bottle and solution that were originally supplied with the sensor (Figure 76). The storage bottle features an open cap and o-ring to form a tight seal around the sensor tip; the solution contains KCl with potassium phthalate and a preservative. If this original solution is not available, one can prepare a 2 M KCl solution or use pH 4 buffer as an alternative, though these solutions should be monitored for microbial growth and replaced if growth is apparent. Other sensors and system components should not be stored in or exposed to these pH buffers for long periods of time.

**NOTICE:** Do NOT let the sensor dry out. Do NOT store the sensor in distilled or deionized water. Either of these will radically shorten the lifespan of the sensor module and void its warranty.

## Sensor Module

The pH and pH/ORP sensors feature user-replaceable sensor modules. These modules contain a reference solution that depletes over time. The warranty period for both of these modules is 12 months:

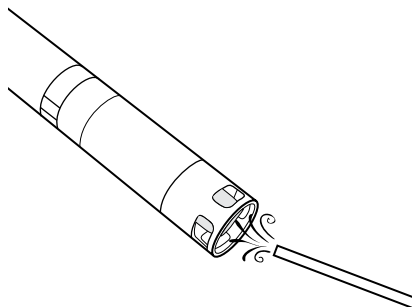
- Replacement pH Module [SKU: 626963] = **12** months
- Replacement pH/ORP Module [SKU: 626964] = **12** months

Depending on usage and storage practices, the module may last longer than its warranty period. Replace the module if the sensor exhibits a slow response time after trying all the cleaning methods listed above.

## 4.10 ISE Sensor

ISE sensors are shipped with their tips in a storage bottle. Keep this bottle for long-term storage.

Do not let the ISE sensor reference electrode junctions dry out. Clean the sensors when deposits, bio-fouling or other contamination appears on the membrane.

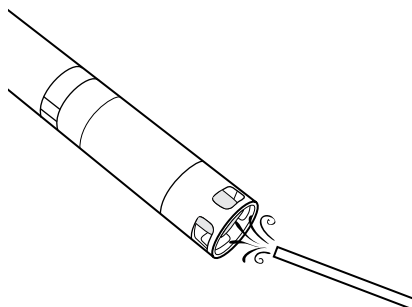


**Figure 77** Ammonium and nitrate maintenance

### Ammonium and Nitrate Sensor Maintenance

1. Carefully clean the ammonium or nitrate sensor by rinsing with DI water followed by soaking in the high standard calibration solution.
2. Carefully dab the sensor dry with a clean, lint-free cloth.

**NOTICE:** The ion-selective membranes are very fragile. Do not use coarse material (e.g. paper towels) to clean the membranes or permanent damage to the sensor can occur. The only exception is fine emery cloth on the chloride sensor.



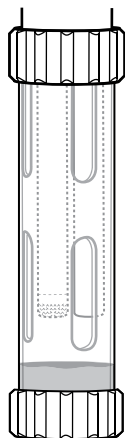
**Figure 78** Chloride maintenance

### Chloride Sensor Maintenance

1. Carefully clean the chloride sensor by carefully polishing with fine emery paper in a circular motion to remove deposits or discoloration.
2. Carefully rinse with DI water to remove any debris.

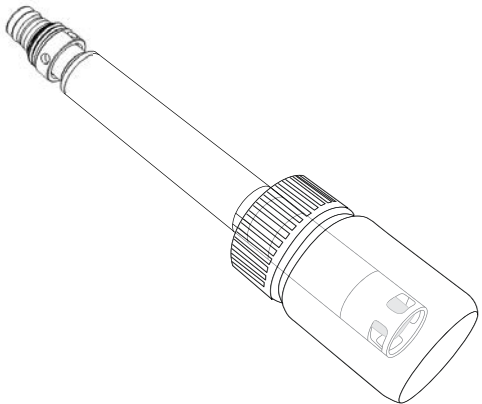
### Short-term Storage:

When in regular field use, ISEs should remain on the bulkhead with the calibration/storage cup installed. Place a small amount of tap or surface water in the cup prior to storage or transport. The probes should be kept in this water-saturated air chamber between uses; not submerged. Make sure the storage cup makes a tight connection to prevent evaporation (Figure 79).



**Figure 79** ISE short-term storage

## ISE Sensor Maintenance and Storage (continued)



**Figure 80** ISE long-term storage

### Long-term Storage:

Remove the sensor from the bulkhead and plug the bulkhead port. Insert the sensor tip into the storage bottle with a small amount of high-calibration solution or tap water. The sensor tip should not be submerged. The storage bottle features an open cap and o-ring to form a tight seal around the sensor tip (Figure 80).

**NOTICE:** Do NOT let the sensor dry out. Do NOT store the ISE sensor in conductivity standard, pH buffer, or salt water. Either of these will radically shorten the lifespan or kill the sensor module and void its warranty.

### Rehydrating the Reference Junction

If an ISE module has been allowed to dry, soak the sensor for several hours (preferably overnight) in the sensor's high-calibration solution. If the sensor is irreparably damaged, the sensor module must be replaced.

## Sensor Module

Ammonium, chloride and nitrate sensors feature user-replaceable sensor modules. These modules contain a reference solution that depletes over time. The warranty period for ISE modules is 6 months:

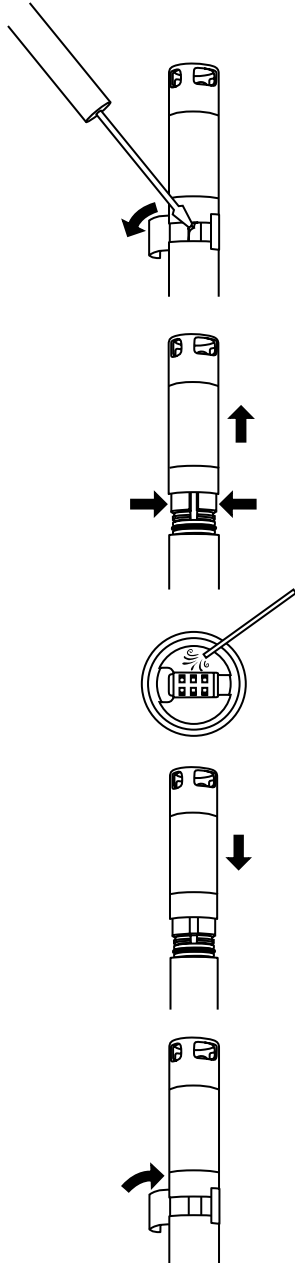
- Replacement Nitrate Module [SKU: 626965] = **6** months
- Replacement Ammonium Module [SKU: 626966] = **6** months
- Replacement Chloride Module [SKU: 626967] = **6** months

Depending on usage and storage practices, the module may last longer than its warranty period. When it is time, perform a sensor module replacement in a clean, dry laboratory environment.

# 4.11

## ProDSS Sensor Module Replacement

Sensor modules for pH, pH/ORP, nitrate, ammonium, and chloride all require periodic replacement. Perform a sensor module replacement in a clean, dry laboratory environment. Remove the sensor from the bulkhead and perform the following steps:



**Figure 81** Sensor module replacement

### Module Replacement

1. Peel off and discard the sticker that covers the junction of the sensor body and the module (Figure 81).
2. With a small, flat-blade screwdriver, carefully remove the square rubber plug from the gap in the hard plastic ring at the base of the sensor module.
3. Using two fingers, squeeze the sensor module's hard plastic ring so that it compresses the gap left by the rubber plug.
4. While squeezing, steadily pull the sensor module straight from the sensor body, rocking slightly if necessary. Do not keep the used o-rings as they are unusable after removal from the sensor body. Discard the old sensor module.
5. Inspect the sensor connector port for debris or moisture. If detected, remove it with lint-free cloth or a light blast of compressed air.
6. The new sensor module comes with two o-rings installed and pre-lubricated. Visually inspect the o-rings for nicks, tears, contaminants or particles. Replace any damaged o-rings.
7. Align the prongs on the base of the sensor module with the slots in the sensor body. The sensor module is keyed to insert in only one orientation. Push the sensor module firmly into position until it clicks. Wipe any excess o-ring lubricant from the assembled components.
8. Wrap the junction of the sensor module and sensor body with the new sticker included in the sensor module kit. The sticker helps keep the sensor module junction clean and retain the rubber plug throughout deployment.
9. Write the replacement date on the sticker.

**NOTICE:** If a sensor module is removed for any reason, the o-rings must be replaced.

**NOTE:** Be sure to calibrate the sensor after module replacement.

# 5. KorDSS Software

## 5.1 Introduction

KorDSS Software and drivers require permissions for successful installation. Administrative privileges may be necessary for a business or networked PC. Contact your organization's IT department for admin privileges.

### System Requirements

#### Supported 32 bit (x86) and 64 bit (x64) Microsoft Operating Systems:

- Microsoft Windows 7 Home Basic SP1
- Microsoft Windows 7 Home Premium SP1
- Microsoft Windows 7 Professional SP1
- Microsoft Windows 7 Enterprise SP1
- Microsoft Windows 7 Ultimate SP1
- Microsoft Windows 8 Home Basic
- Microsoft Windows 8 Home Premium
- Microsoft Windows 8 Professional
- Microsoft Windows 8 Enterprise
- Microsoft Windows 8.1 Basic
- Microsoft Windows 8.1 Professional
- Microsoft Windows 8.1 Enterprise
- Microsoft Windows 10 Home
- Microsoft Windows 10 Professional
- Microsoft Windows 10 Enterprise
- Microsoft Windows 10 Education

#### Ram Memory Requirement:

- Minimum of 2 GB of RAM installed

#### Hard Disk Free Space:

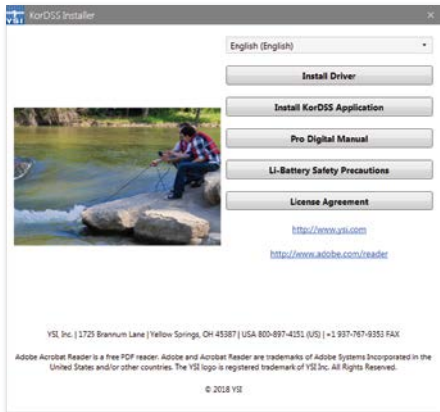
- Minimum of 500 MB of free hard drive space

#### Internet Access Required to Support:

- Software and device updates, software licensing

## 5.2

# Installing the Driver and Software



**Figure 82** KorDSS Installer



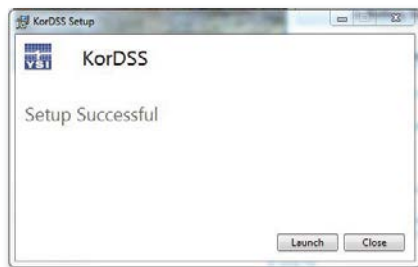
**Figure 83** ProDSS Driver Installer



**Figure 84** Back button



**Figure 85** KorDSS license agreement



**Figure 86** Launch KorDSS

Follow these steps to complete the installation process and establish connection to the handheld:

**NOTE:** Be sure to install the driver **before** connecting the handheld to your PC for the first time.

1. Insert the supplied USB flash drive into a USB port on your computer.
2. Depending on the PC operating system and system settings, the KorDSS Installer may appear. If it does not appear, open the flash drive in Windows Explorer and double-click **Start.exe** to start the installer. [Figure 82](#) shows how the installer will appear once it starts.
3. On the KorDSS Installer, click **Install Driver**. Then choose to Install the driver on the screens that follow ([Figure 83](#)).
4. After the driver has installed, choose to go **Back** to the KorDSS Installer ([Figure 84](#)).
5. On the KorDSS Installer, click **Install KorDSS Application**. A license agreement will appear ([Figure 85](#)).
6. You may be asked if you want to allow a program from an unknown publisher to make changes on the computer. If so, select **Yes**.
7. After successful installation of KorDSS, click **Launch** to start the program ([Figure 86](#)).
8. Connect the handheld meter to the PC with the supplied USB cable.
9. Power on the handheld and click **Connect** when it appears under the **Instrument Connection Panel**; there may be a short delay before it appears in the software.



# 6. Accessories

## 6.1 Ordering

Telephone: 800 897 4151 (USA)

+1 937 767 7241 (Globally) Monday through Friday

8:00 AM to 5:00 ET

Fax: +1 937 767 9353 (orders)

Email: [info@ysi.com](mailto:info@ysi.com)

Mail: YSI Incorporated 1725 Brannum Lane

Yellow Springs, OH 45387 USA

Web: Visit [YSI.com](http://YSI.com) to order replacement parts, accessories, and calibration solutions.

When placing an order please have the following available:

1. YSI account number (if available)
2. Name and phone number
3. Purchase Order or Credit Card number
4. Model Number or brief description
5. Billing and shipping addresses
6. Quantity

## ProDIGITAL Handhelds

YSI Item #	Description
626650	ProSolo handheld, no GPS, not compatible with ProDSS 4-port cable assemblies
626870-1	ProDSS handheld, no GPS
626870-2	ProDSS handheld with GPS

## ProDIGITAL Probe Assemblies

**NOTE:** The ODO and OBOD sensor caps come pre-installed on the following probe assemblies, with calibration coefficients of the sensor cap pre-loaded into the probe at the factory.

YSI Item #	Description
	Optical Dissolved Oxygen and Temperature Probes
627200-1	ODO/T Probe Assembly, 1m
627200-4	ODO/T Probe Assembly, 4m
627200-10	ODO/T Probe Assembly, 10m
627200-20	ODO/T Probe Assembly, 20m
627200-30	ODO/T Probe Assembly, 30m
627200-50	ODO/T Probe Assembly, 50m
627200-100	ODO/T Probe Assembly, 100m
	Optical Dissolved Oxygen, Conductivity, and Temperature Probes
627150-1	ODO/CT Probe Assembly, 1m
627150-4	ODO/CT Probe Assembly, 4m
627150-10	ODO/CT Probe Assembly, 10m
627150-20	ODO/CT Probe Assembly, 20m
627150-30	ODO/CT Probe Assembly, 30m
627150-50	ODO/CT Probe Assembly, 50m
627150-100	ODO/CT Probe Assembly, 100m
	Self-Stirring Optical Biochemical Oxygen Demand Probes
626400	ProOBOD probe assembly (lab BOD probe); U.S./Japanese version with power supply
626401	ProOBOD probe assembly (lab BOD probe); International version with power supply

## ProDSS 4-Port Cable Assemblies (No Sensors Included)

YSI Item #	Description
626909-1	ProDSS-1 meter 4-port cable assembly, no depth
626909-4	ProDSS-4 meter 4-port cable assembly, no depth
626909-10	ProDSS-10 meter 4-port cable assembly, no depth
626909-20	ProDSS-20 meter 4-port cable assembly, no depth
626909-30	ProDSS-30 meter 4-port cable assembly, no depth
626909-40	ProDSS-40 meter 4-port cable assembly, no depth
626909-50	ProDSS-50 meter 4-port cable assembly, no depth
626909-60	ProDSS-60 meter 4-port cable assembly, no depth
626909-70	ProDSS-70 meter 4-port cable assembly, no depth
626909-80	ProDSS-80 meter 4-port cable assembly, no depth
626909-90	ProDSS-90 meter 4-port cable assembly, no depth
626909-100	ProDSS-100 meter 4-port cable assembly, no depth
626910-1	ProDSS-1 meter 4-port cable assembly, with depth
626910-4	ProDSS-4 meter 4-port cable assembly, with depth
626910-10	ProDSS-10 meter 4-port cable assembly, with depth
626911-20	ProDSS-20 meter 4-port cable assembly, with depth
626911-30	ProDSS-30 meter 4-port cable assembly, with depth
626911-40	ProDSS-40 meter 4-port cable assembly, with depth
626911-50	ProDSS-50 meter 4-port cable assembly, with depth
626911-60	ProDSS-60 meter 4-port cable assembly, with depth
626911-70	ProDSS-70 meter 4-port cable assembly, with depth
626911-80	ProDSS-80 meter 4-port cable assembly, with depth
626911-90	ProDSS-90 meter 4-port cable assembly, with depth
626911-100	ProDSS-100 meter 4-port cable assembly, with depth

## ProDSS Sensors (for 4-Port Cable Assemblies)

YSI Item #	Description
626900	Optical dissolved oxygen sensor
626902	Conductivity and temperature sensor
626901	Turbidity sensor
626903	pH sensor with module
626904	pH/ORP sensor with module
626906	Ammonium sensor with module
626905	Nitrate sensor with module
626907	Chloride sensor with module
626210	Total algae sensor, PC
626211	Total algae sensor, PE

## Replacement Sensor Modules and ODO Sensor Caps

YSI Item #	Description
626890	Replacement ProDSS Optical Dissolved Oxygen sensor cap (for 626900 smart sensor)
626482	Replacement ProOBOD Optical Dissolved Oxygen sensor cap (for 626400 or 626401 lab probes)
627180	Replacement ODO Extended Warranty Sensor Cap (only compatible with ODO/T and ODO/CT probe assemblies)
626963	Replacement ProDSS pH sensor module
626964	Replacement ProDSS pH/ORP sensor module
626966	Replacement ProDSS Ammonium sensor module
626965	Replacement ProDSS Nitrate sensor module
626967	Replacement ProDSS Chloride sensor module

## Calibration Standards

YSI Item #	Description
065270	Conductivity standard, 1000 $\mu\text{mhos/cm}$ (quart, glass); ideal for fresh water
065272	Conductivity standard, 10000 $\mu\text{mhos/cm}$ (quart, glass); ideal for brackish water
065274	Conductivity standard, 100000 $\mu\text{mhos/cm}$ (quart, glass); ideal for supersaturated sea water
060907	Conductivity standard, 1000 $\mu\text{mhos/cm}$ (box of 8 individual pints, plastic); ideal for fresh water
060906	Conductivity standard, 1413 $\mu\text{mhos/cm}$ , $\pm 1\%$ , 0.01 M KCl (box of 8 individual pints, plastic)
060911	Conductivity standard, 10000 $\mu\text{mhos/cm}$ (box of 8 individual pints, plastic); ideal for brackish water
060660	Conductivity standard, 50000 $\mu\text{mhos/cm}$ (box of 8 individual pints, plastic); ideal for sea water
061320	ORP (mV) standard, Zobell solution, powder - needs hydrated (125 mL bottle, plastic)
061321	ORP (mV) standard, Zobell solution, powder - needs hydrated (250 mL bottle, plastic)
061322	ORP (mV) standard, Zobell solution, powder - needs hydrated (500 mL bottle, plastic)
003821	pH 4 buffer (box of 6 individual pints, plastic); ideal for storage solution for pH sensor
003822	pH 7 buffer (box of 6 individual pints, plastic)
003823	pH 10 buffer (box of 6 individual pints, plastic)
603824	Assorted case of pH 4, 7, and 10 buffers (2 individual pints of each buffer, plastic)
005580	Confidence solution to verify conductivity, pH and ORP system (box of 6 individual 475 mL bottles, plastic). <b>Note:</b> <i>Not for calibration</i>
003841	Ammonium standard, 1 mg/L (500 mL, plastic)
003842	Ammonium standard, 10 mg/L (500 mL, plastic)
003843	Ammonium standard, 100 mg/L (500 mL, plastic)
003885	Nitrate standard, 1 mg/L (500 mL, plastic)
003886	Nitrate standard, 10 mg/L (500 mL, plastic)
003887	Nitrate standard, 100 mg/L (500 mL, plastic)
608000	Turbidity standard, 0 FNU (1 gallon, plastic)
607200	Turbidity standard, 12.4 FNU (1 gallon, plastic)
607300	Turbidity standard, 124 FNU (1 gallon, plastic)
607400	Turbidity standard, 1010 FNU (1 gallon, plastic)





## ProDIGITAL Accessories

YSI Item #	Description
626946	Large, hard-sided carrying case (Fits ProDSS 4-port cables 10, 20, and 30 meters in length, cable management kit, handheld, and accessories)
603075	Large, soft-sided carrying case
626945	Small, hard-sided carrying case (Fits ProDSS 4-port cables 1 and 4 meters in length, handheld, flow cell, and accessories)
599080	Flow cell for ProDSS 4-port cables
603076	Flow cell for ODO/CT cables (requires single port adapter; 603078)
603078	Adapter required for ODO/CT flow cell (603076)
603056	Flow cell mounting spike
063507	Tripod (screws into back of meter)
063517	Ultra clamp (screws into back of meter)
603070	Shoulder strap
603069	Belt clip (screws into back of meter)
626942	USB car charger
626943	Small external Li-Ion rechargeable battery pack (Typical performance: will charge a completely discharged handheld battery to about 50%)
626944	Large external Li-Ion rechargeable battery pack (Typical performance: will charge a completely discharged battery to full charge, plus have power to charge a second battery to 20%)
626940	AC charger (USA). Includes power supply and USB cable (included with handheld)
626941	AC charger (international). Includes power supply, USB cable and outlet adapters (included with handheld)
626846	Replacement Lithium-ion battery pack
626969	USB flash drive (included with handheld)
626991	Cable for charging and PC connection (included as part of 626940 and 626941)
626992	Cable for connection to USB drive (included with handheld)
626990	ProDSS maintenance kit (included with all ProDSS 4-port cables): <ul style="list-style-type: none"> <li>• 3 port plugs</li> <li>• 1 tube of o-ring lubricant</li> <li>• 1 brush</li> <li>• 1 syringe</li> <li>• 1 sensor installation/removal tool</li> <li>• O-rings (6)</li> </ul>
626919	Sensor guard for 4-port ProDSS cable assembly (included with all 4-port cables)
599786	Calibration/storage cup for 4-port ProDSS cable assembly (included with all 4-port ProDSS cables)
627195	Calibration cup for ODO/CT cable assembly (included with all ODO/CT cables)
603062	Cable management kit (included with <b>ProDSS 4-port cables</b> 10, 20, and 30-meters long; <b>ODO/CT cables</b> 4, 10, 20, and 30-meters long; and <b>ODO/T cables</b> 4, 10, 20, and 30-meters long)
626918	1 lb weight (included with ProDSS 4-port cables 10-meters and longer)
605978	4.9 oz weight

# 7. Safety and Support

## 7.1

## Rechargeable Lithium-Ion Battery Pack Safety Warnings and Precautions

-  **CAUTION:** Failure to follow the safety warnings and precautions can result in fire, personal injury and/or equipment damage not covered under warranty.
-  **CAUTION:** If the internal battery fluid comes into contact with skin, wash the affected area(s) with soap and water immediately. If it comes into contact with your eye(s), flush them with generous amounts of water for 15 minutes and seek immediate medical attention.
-  **CAUTION:** Always keep batteries away from children.
-  **WARNING:** In the unlikely event a lithium-ion battery catches fire, **DO NOT** attempt to put the fire out with water, use a Class A, B or C fire extinguisher.


### Do:


- Store the battery pack in a cool, dry, ventilated area.
- Store the battery pack in a non-conductive and fireproof container.
- Store the battery pack at approximately 50% of the capacity.
- Disconnect the battery pack when not in use and for long-term storage.
- Follow applicable laws and regulations for transporting and shipping of batteries.
- *Immediately discontinue* use of the battery pack if, while using, charging or storing the battery pack:
  - Emits an unusual smell
  - Feel hot
  - Changes color
  - Changes shape
  - Appears abnormal in any other way.

### Battery Pack General Precautions:

- **DO NOT** put the battery in fire or heat the battery.
- **DO NOT** connect the positive and the negative terminal of the battery to each other with any metal object (e.g. wire).
- **DO NOT** carry or store the battery pack with necklaces, hairpins or other metal objects.
- **DO NOT** carry or store the battery pack with hazardous or combustible materials.
- **DO NOT** pierce the battery pack with nails, strike with a hammer, step on or otherwise subject the battery pack to strong impacts or shocks.
- **DO NOT** solder directly onto the battery pack.
- **DO NOT** expose the battery pack to water or salt water or allow it to get wet.
- **DO NOT** disassemble or modify the battery pack. The battery contains safety and protection devices that, if damaged, can cause the battery to generate heat, rupture or ignite.
- **DO NOT** place the battery pack on or near fires, stoves or other high-temperature locations.
- **DO NOT** place the battery pack in direct sunlight or extreme temperatures for extended periods of time or store the battery pack inside cars in hot weather. Doing so may cause the battery pack to generate heat, rupture or ignite. Using the battery pack in this manner may also result in a loss of performance and a shortened life expectancy.
- **DO NOT** place the battery pack in microwave ovens, high-pressure containers or on induction cookware.
- **DO NOT** ship damaged or potentially defective batteries to YSI or any of our authorized service centers unless instructed otherwise. All federal and international shipping laws should be consulted prior to shipping lithium-ion batteries.

## Charging/Discharging/Handling the Battery Pack

 **WARNING:** Failure to follow the battery pack charging/discharging instructions can cause the battery to become hot, rupture or ignite and cause serious injury and/or equipment damage.

 **WARNING:** Only charge the battery using charging devices designed specifically for the ProDIGITAL handheld by YSI. Use of unapproved chargers can result in battery failure and potentially serious injury to the user.

If at any time the battery pack becomes damaged, hot or begins to balloon or swell, discontinue charging (or discharging) immediately. Quickly and safely disconnect the charger. Then place the battery pack and/or charger in a safe, open area away from flammable materials. After one hour of observation, remove the battery pack from service. **DO NOT** continue to handle, attempt to use or ship the battery.

Damaged or swollen batteries can be unstable and very hot. **DO NOT** touch batteries until they have cooled. In the event of a fire use a Class A, B, or C fire extinguisher. **DO NOT** use water.

- **DO NOT** attach the battery pack to a power supply plug or directly to a car's cigarette lighter.
- **DO NOT** place the battery pack in or near fire or into direct extended exposure to sunlight. When the battery pack becomes hot, the built-in safety equipment is activated, preventing the battery pack from charging further. Heating the battery pack can destroy the safety equipment and cause additional heating, breaking or ignition.
- **DO NOT** leave the battery pack unattended while charging.

**NOTICE:** The ambient temperature range over which the battery pack can be discharged is -20°C to 60°C (-4°F to 140°F). Use of the battery pack outside of this temperature range may damage the performance of the battery pack or may reduce its life expectancy.

- **DO NOT** discharge the battery pack using any device except for a ProDIGITAL handheld. When the battery pack is used in other devices it may damage the performance of the battery or reduce its life expectancy. Use of a non-approved device to discharge the battery pack can cause an abnormal current to flow, resulting in the battery pack to become hot, rupture or ignite and cause serious injury.
- **DO NOT** leave the battery pack unattended while discharging.

## Battery Disposal

When the battery pack is worn out, insulate the terminals with adhesive tape or similar materials before disposal. Dispose of the battery pack in the manner required by your city, county, state or country. For details on recycling lithium-ion batteries, please contact a government recycling agency, your waste-disposal service or visit reputable online recycling sources such as [www.batteryrecycling.com](http://www.batteryrecycling.com).

This product must not be disposed of with other waste. Instead, it is the user's responsibility to dispose of their waste equipment by handing it over to a designated collection point for the recycling of waste electrical and electronic equipment. The separate collection and recycling of your waste equipment at the time of disposal will help to conserve natural resources and ensure that it is recycled in a manner that protects human health and the environment.

For more information about where you can drop off your waste equipment for recycling, please contact your local city office, or your local waste disposal service. **DO NOT ship batteries to YSI or a YSI authorized service center unless instructed to do otherwise.**

Contact YSI Technical Support at (937) 767-7241 if you have additional questions.

## 7.2 Service Information

YSI has authorized service centers throughout the United States and Internationally. For the nearest service center information, please visit [ysi.com](http://ysi.com) and click 'Support' or contact YSI Technical Support directly at 800-897-4151 (+1 937-767-7241).

When returning a product for service, include the Product Return form with cleaning certification. The form must be completely filled out for a YSI Service Center to accept the instrument for service. The form may be downloaded from [YSI.com](http://YSI.com).

## 7.3 Technical Support

Telephone: 800 897 4151 (USA)

+1 937 767 7241 (Globally) Monday through Friday, 8:00 AM to 5:00 ET

Fax: +1 937 767 9353 (orders)

Email: [info@ysi.com](mailto:info@ysi.com)

Mail: YSI Incorporated 1725 Brannum Lane Yellow Springs, OH 45387 USA

Internet: [YSI.com](http://YSI.com)



# 7.4

## Declaration of Conformity

The undersigned hereby declares on behalf of the named manufacturer under our sole responsibility that the listed product conforms to the requirements for the listed European Council Directive(s) and carries the CE mark accordingly.

<i>Manufacturer:</i>	YSI Incorporated 1725 Brannum Lane Yellow Springs, OH 45387 USA
<i>Product Name:</i>	ProDSS, ProSolo
<i>Conforms to the following:</i>	
<i>Directives:</i>	EMC 2004/108/EC RoHS 2011/65/EU WEEE 2012/19/EU
<i>Harmonized Standards:</i>	EN61326-1:2013 (IEC 61326-1:2012) IEC 61000-3-2:2005 +A1:2008+A2:2009 IEC 61000-3-3:2008
<i>Supplementary Information:</i>	All performance met the operation criteria as follows: 1. ESD, IEC 61000-4-2:2008 2. Radiated Immunity, IEC 61000-4-3:2006 +A1:2007+A2:2010 3. Electrical Fast Transient (EFT), IEC 61000-4-4:2004 +A1:2010 4. Immunity to Surge, IEC 61000-4-5:2005 5. Radio Frequency, Continuous Conducted Immunity, IEC61000-4-6:2008 6. IEC 61000-4-8:2009 7. IEC 61000-4-11:2004
<i>Authorized EU Representative</i>	Xylem Analytics UK Ltd Unit 2 Focal Point, Lacerta Court, Works Road Letchworth, Hertfordshire, SG6 1FJ UK



Signed: Lisa M. Abel  
Title: Director of Quality

Date: March 16, 2018

The undersigned hereby declares on behalf of the named manufacturer under our sole responsibility that the listed product conforms to the requirements for electrical equipment under US FCC Part 15 and ICES-003 for unintentional radiators.

<i>Manufacturer:</i>	YSI Incorporated 1725 Brannum Lane Yellow Springs, OH 45387 USA
<i>Product Name:</i>	Professional Digital Sampling System Instrument
<i>Model Numbers</i>	
<i>Instrument/Accessory:</i>	ProDSS non-GPS (626870-1) / ProDSS GPS (626870-2), ProSolo (626650)
<i>Probe/Cable Assemblies:</i>	626909-1, 626909-4, 626909-10, 626909-20, 626909-30, 626909-40, 626909-50, 626909-60, 626909-70, 626909-80, 626909-90, 626909-100, 626910-1, 626910-4, 626910-10, 626911-20, 626911-30, 626911-40, 626911-50, 626911-60, 626911-70, 626911-80, 626911-90, 626911-100  627200-1, 62700-4, 627200-10, 627200-20, 627200-30, 627200-50, 627200-100  627150-1, 627150-4, 627150-10, 627150-20, 627150-30, 627150-50, 627150-100  626250-1, 626250-4, 626250-10, 626250-20, 626250-30, 626250-40, 626250-50, 626250-60, 626250-70, 626250-80, 626250-90, 626250-100  626400, 626401
<i>Sensors:</i>	626900, 626902, 626901, 626903, 626904, 626906, 626905, 626907, 626210, 626211
<i>Conforms to the following:</i>	
<i>Standards:</i>	<ul style="list-style-type: none"> <li>• FCC 47 CFR Part 15-2008, Subpart B, Class B, Radio Frequency Devices</li> <li>• ICES-003:2004, Digital Apparatus</li> </ul>
<i>Supplementary Information:</i>	Tested using ANSI C63.4-2003 (excluding sections 4.1, 5.2, 5.7, 9, and 14)



Signed: Lisa M. Abel  
Title: Director of Quality

Date: March 16, 2018

# 7.5

## Warranty

The YSI Professional Series Digital (ProDIGITAL) handheld meters are warranted for three (3) years from date of purchase by the end user against defects in materials and workmanship. Digital sensors and cables (ProDSS 4-port, ODO/CT, ODO/T, and ProOBOD) are warranted for two (2) years from date of purchase by the end user against defects in material and workmanship. The ODO Extended Warranty Sensor Cap (627180) for the ODO/T and ODO/CT cable assemblies is warranted for two (2) years from date of purchase by the end user against defects in material and workmanship. ProDSS pH and pH/ORP sensor modules, optical ODO sensor caps (all but the 627180 cap previously mentioned), and Li-Ion battery pack are warranted for one (1) year from date of purchase by the end user against defects in material and workmanship; ProDSS ISE sensor modules (ammonium, nitrate, and chloride) are warranted for 6 months. ProDIGITAL systems (instrument, cables & sensors) are warranted for 1 year (excluding sensor modules) from date of purchase by the end user against defects in material and workmanship when purchased by rental agencies for rental purposes. Within the warranty period, YSI will repair or replace, at its sole discretion, free of charge, any product that YSI determines to be covered by this warranty.

To exercise this warranty, call your local YSI representative, or contact YSI Customer Service in Yellow Springs, Ohio at +1 937 767-7241, 800-897-4151 or visit [www.YSI.com](http://www.YSI.com) (Support tab) for a Product Return Form. Send the product and proof of purchase, transportation prepaid, to the Authorized Service Center selected by YSI. Repair or replacement will be made and the product returned, transportation prepaid. Repaired or replaced products are warranted for the balance of the original warranty period, or at least 90 days from date of repair or replacement.

### LIMITATION OF WARRANTY

This Warranty does not apply to any YSI product damage or failure caused by:

1. Failure to install, operate or use the product in accordance with YSI's written instructions;
2. Abuse or misuse of the product;
3. Failure to maintain the product in accordance with YSI's written instructions or standard industry procedure;
4. Any improper repairs to the product;
5. Use by you of defective or improper components or parts in servicing or repairing the product;
6. Modification of the product in any way not expressly authorized by YSI.

THIS WARRANTY IS IN LIEU OF ALL OTHER WARRANTIES, EXPRESSED OR IMPLIED, INCLUDING ANY WARRANTY OF MERCHANTABILITY OR FITNESS FOR A PARTICULAR PURPOSE. YSI's LIABILITY UNDER THIS WARRANTY IS LIMITED TO REPAIR OR REPLACEMENT OF THE PRODUCT, AND THIS SHALL BE YOUR SOLE AND EXCLUSIVE REMEDY FOR ANY DEFECTIVE PRODUCT COVERED BY THIS WARRANTY. IN NO EVENT SHALL YSI BE LIABLE FOR ANY SPECIAL, INDIRECT, INCIDENTAL OR CONSEQUENTIAL DAMAGES RESULTING FROM ANY DEFECTIVE PRODUCT COVERED BY THIS WARRANTY.

# 8. Appendices

## 8.1

### Appendix A DO% Calibration Values

Calibration Value D.O. %	Pressure			
	in Hg	mmHg	kPa	mbar
101%	30.22	767.6	102.34	1023.38
100%	29.92	760.0	101.33	1013.25
99%	29.62	752.4	100.31	1003.12
98%	29.32	744.8	99.30	992.99
97%	29.02	737.2	98.29	982.85
96%	28.72	729.6	97.27	972.72
95%	28.43	722.0	96.26	962.59
94%	28.13	714.4	95.25	952.46
93%	27.83	706.8	94.23	942.32
92%	27.53	699.2	93.22	932.19
91%	27.23	691.6	92.21	922.06
90%	26.93	684.0	91.19	911.93
89%	26.63	676.4	90.18	901.79
88%	26.33	668.8	89.17	891.66
87%	26.03	661.2	88.15	881.53
86%	25.73	653.6	87.14	871.40
85%	25.43	646.0	86.13	861.26
84%	25.13	638.4	85.11	851.13
83%	24.83	630.8	84.10	841.00
82%	24.54	623.2	83.09	830.87
81%	24.24	615.6	82.07	820.73
80%	23.94	608.0	81.06	810.60
79%	23.64	600.4	80.05	800.47
78%	23.34	592.8	79.03	790.34
77%	23.04	585.2	78.02	780.20
76%	22.74	577.6	77.01	770.07
75%	22.44	570.0	75.99	759.94
74%	22.14	562.4	74.98	749.81
73%	21.84	554.8	73.97	739.67
72%	21.54	547.2	72.95	729.54

# 8.2

## Appendix B Oxygen Solubility Table

Solubility of oxygen in mg/L in water exposed to water-saturated air at 760 mm Hg pressure.

Salinity = Measure of quantity of dissolved salts in water.

Chlorinity = Measure of chloride content, by mass, of water.

$S(0/00) = 1.80655 \times \text{Chlorinity}(0/00)$

Temp °C	Chlorinity : 0 Salinity: 0	5.0 ppt 9.0 ppt	10.0 ppt 18.1 ppt	15.0 ppt 27.1 ppt	20.0 ppt 36.1 ppt	25.0 ppt 45.2 ppt
0.0	14.62	13.73	12.89	12.10	11.36	10.66
1.0	14.22	13.36	12.55	11.78	11.07	10.39
2.0	13.83	13.00	12.22	11.48	10.79	10.14
3.0	13.46	12.66	11.91	11.20	10.53	9.90
4.0	13.11	12.34	11.61	10.92	10.27	9.66
5.0	12.77	12.02	11.32	10.66	10.03	9.44
6.0	12.45	11.73	11.05	10.40	9.80	9.23
7.0	12.14	11.44	10.78	10.16	9.58	9.02
8.0	11.84	11.17	10.53	9.93	9.36	8.83
9.0	11.56	10.91	10.29	9.71	9.16	8.64
10.0	11.29	10.66	10.06	9.49	8.96	8.45
11.0	11.03	10.42	9.84	9.29	8.77	8.28
12.0	10.78	10.18	9.62	9.09	8.59	8.11
13.0	10.54	9.96	9.42	8.90	8.41	7.95
14.0	10.31	9.75	9.22	8.72	8.24	7.79
15.0	10.08	9.54	9.03	8.54	8.08	7.64
16.0	9.87	9.34	8.84	8.37	7.92	7.50
17.0	9.67	9.15	8.67	8.21	7.77	7.36
18.0	9.47	8.97	8.50	8.05	7.62	7.22
19.0	9.28	8.79	8.33	7.90	7.48	7.09
20.0	9.09	8.62	8.17	7.75	7.35	6.96
21.0	8.92	8.46	8.02	7.61	7.21	6.84
22.0	8.74	8.30	7.87	7.47	7.09	6.72
23.0	8.58	8.14	7.73	7.34	6.96	6.61
24.0	8.42	7.99	7.59	7.21	6.84	6.50
25.0	8.26	7.85	7.46	7.08	6.72	6.39
26.0	8.11	7.71	7.33	6.96	6.62	6.28
27.0	7.97	7.58	7.20	6.85	6.51	6.18
28.0	7.83	7.44	7.08	6.73	6.40	6.09
29.0	7.69	7.32	6.93	6.62	6.30	5.99
30.0	7.56	7.19	6.85	6.51	6.20	5.90
31.0	7.43	7.07	6.73	6.41	6.10	5.81
32.0	7.31	6.96	6.62	6.31	6.01	5.72

<b>Temp °C</b>	<b>Chlorinity : 0 Salinity: 0</b>	<b>5.0 ppt 9.0 ppt</b>	<b>10.0 ppt 18.1 ppt</b>	<b>15.0 ppt 27.1 ppt</b>	<b>20.0 ppt 36.1 ppt</b>	<b>25.0 ppt 45.2 ppt</b>
33.0	7.18	6.84	6.52	6.21	5.91	5.63
34.0	7.07	6.73	6.42	6.11	5.82	5.55
35.0	6.95	6.62	6.31	6.02	5.73	5.46
36.0	6.84	6.52	6.22	5.93	5.65	5.38
37.0	6.73	6.42	6.12	5.84	5.56	5.31
38.0	6.62	6.32	6.03	5.75	5.48	5.23
39.0	6.52	6.22	5.98	5.66	5.40	5.15
40.0	6.41	6.12	5.84	5.58	5.32	5.08
41.0	6.31	6.03	5.75	5.49	5.24	5.01
42.0	6.21	5.93	5.67	5.41	5.17	4.93
43.0	6.12	5.84	5.58	5.33	5.09	4.86
44.0	6.02	5.75	5.50	5.25	5.02	4.79
45.0	5.93	5.67	5.41	5.17	4.94	4.72

# Xylem |'zīləm|

- 1) The tissue in plants that brings water upward from the roots;
- 2) a leading global water technology company.

We're a global team unified in a common purpose: creating advanced technology solutions to the world's water challenges. Developing new technologies that will improve the way water is used, conserved, and re-used in the future is central to our work. Our products and services move, treat, analyze, monitor and return water to the environment, in public utility, industrial, residential and commercial building services settings. Xylem also provides a leading portfolio of smart metering, network technologies and advanced analytics solutions for water, electric and gas utilities. In more than 150 countries, we have strong, long-standing relationships with customers who know us for our powerful combination of leading product brands and applications expertise with a strong focus on developing comprehensive, sustainable solutions.

**For more information on how Xylem can help you, go to [www.xylem.com](http://www.xylem.com)**



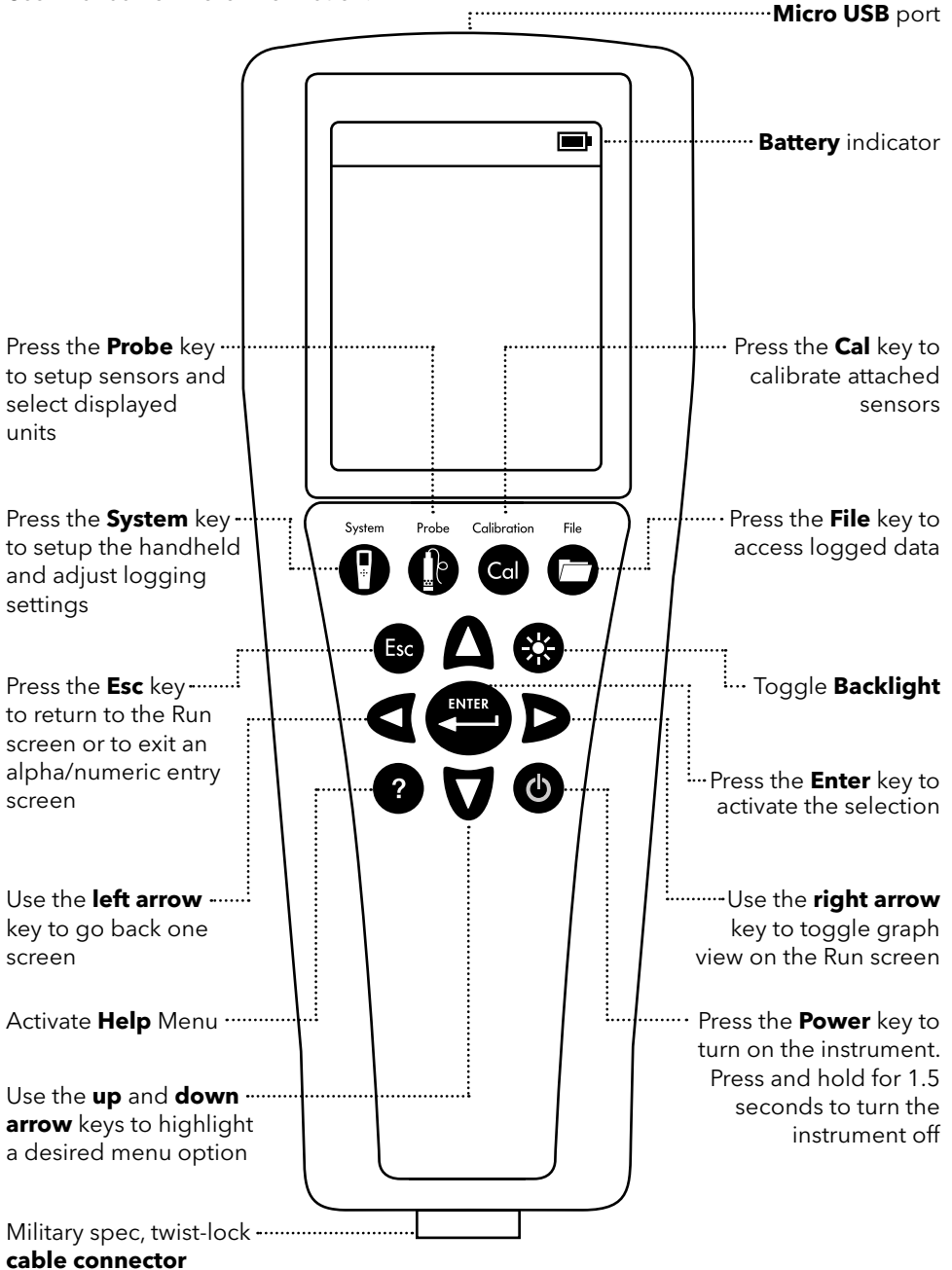
YSI, a Xylem brand  
1725 Brannum Lane  
Yellow Springs, OH 45387  
Tel +1.800.897.4151  
Fax +1.937.767.9353  
[www.xylem.com](http://www.xylem.com)

# Pro D·I·G·I·T·A·L

## Quick Start Guide

Item #626972REF


This is a reference guide for operating the ProDIGITAL line of handhelds. Refer to the User Manual for more information.








## Setting Up

---

 Charge the battery by connecting the handheld to an AC power supply or USB connector using the micro USB cable. Ensure all components are dry when charging. A full charge takes approximately 9 hours.


 Make sure the **date/time** is correct and set the **logging mode** (Single or Continuous).

 Setup sensor parameters and select **units displayed** on the Run and Data View screens.

 **Calibrate sensors** prior to taking measurements; sensor-specific calibration instructions can be found in the User Manual.


## Taking Measurements

---

 Insert the probe into the sample and briefly move it up and down to release any air bubbles. Allow measurements to stabilize and press the Enter key to **log data**. To stop Continuous logging, simply press the Enter key again.

## Data Management

---

 Press the File key to **view, delete, or backup** logged data. Data can be filtered by date/time and by the user-created Site and/or Data ID.

 Transfer data to your PC using **KorDSS Software**. Make sure the instrument driver and software are installed from the included USB flash drive or from **YSI.com**.

1. Open KorDSS Software.
2. Use the micro USB cable to connect the handheld to the PC.
3. Power on the handheld; there may be a short delay before it shows up in the software.
4. Select the handheld under the **Instrument Connection Panel** and click Connect.
5. Click **Start Download from Device**.
6. After data download, click **View Logged Data** to view, print, and export data files from KorDSS.